

01

ROUND STONES

Round Stones are loose crystal elements. Most of them are pointed on the reverse side, making them easy to apply in either metal claw settings or pre-set cavities.

The assortment features a wide variety of different cuts and sizes, the most innovative one being the XIRIUS Chaton and the smallest one being the XERO Chaton in size PPO.

The science of the cut and the celebration of crystal as high art come together in the XIRIUS Chaton, Swarovski's most brilliant crystal element ever.

Merging a gemstone-like cut with rich, varied color and Platinum Pro colored foiling for exceptional durability, XIRIUS takes crystal one step closer to the diamond.



































COLORS & EFFECTS

OPEN TO SEE COLORS & EFFECTS























COLORS

 Crystal 001	 Capri Blue 243
 White Opal 234	 Dark Indigo 288
 Light Silk 261	 Montana 207
 Silk 391	 Turquoise 267
 Light Peach 362	 Light Turquoise 263
 Rose Water Opal 395	 Blue Zircon 229
 Vintage Rose 319	 Indicolite 379
 Blush Rose 257	 Indian Sapphire 217
 Light Rose 223	 Denim Blue 266
 Rose Peach 262	 Black Diamond 215
 Padparadscha 542	 Pacific Opal 390
 Indian Pink 289	 Chrysolite 238
 Light Siam 227	 Peridot 214
 Indian Siam¹ 327	 Erinite 360
 Rose 209	 Fern Green 291
 Fuchsia 502	 Emerald 205
 Ruby 501	 Olivine 228
 Siam 208	 Greige 284
 Burgundy 515	 Light Grey Opal 383
 Amethyst 204	 Light Colorado Topaz 246
 Cyclamen Opal 398	 Jonquil 213
 Purple Velvet 277	 Yellow Opal 231
 Tanzanite 539	 Light Topaz 226
 Violet 371	 Sunflower 292
 Light Amethyst 212	 Topaz 203
 Smoky Mauve 265	 Tangerine 259
 Provence Lavender 283	 Light Smoked Topaz 221
 Light Sapphire 211	 Smoked Topaz 220
 Light Azure 361	 Smoky Quartz 225
 Aquamarine 202	 Graphite 253
 Air Blue Opal 285	 Jet 280
 Sapphire 206	

EFFECTS

 Crystal Silver Shade 001 SSHA	 Crystal Luminous Green* 001 LUMG
 Crystal Moonlight 001 MOL	 Crystal Golden Shadow 001 GSHA
 Crystal Aurore Boreale 001 AB	 Crystal Metallic Sunshine* 001 METSH
 Crystal Rose Gold* 001 ROGL	 Crystal Astral Pink 001 API
 Crystal Rose Gold* 001 ROGL	 Crystal Antiqué Pink* 001 ANTP
 Crystal Vitrail Light** 001 VL	 Crystal Vitrail Medium** 001 VM
 Crystal Paradise Shine 001 PARSH	 Crystal Lilac Shadow 001 LISH
 Crystal Bermuda Blue** 001 BBL	 Crystal White Patina 001 WHIPA
 Crystal Metallic Blue* 001 METBL	 Crystal Rose Patina* 001 ROSPA
 Crystal Blue Shade* 001 BLSH	 Crystal Silver Patina* 001 SILPA
 Crystal Scarabaeus Green*/*** 001 SCGR	 Crystal Gold Patina* 001 GOLPA
 Crystal Rainbow Dark* 001 RABDK	 Crystal Black Patina* 001 BLAPA
 Crystal Iridescent Green* 001 IRIG	 Crystal Dark Grey* 001 L111S
 Crystal Dorado* 001 DOR	 Crystal Dark Red* 001 L108S
 Crystal Metallic Light Gold* 001 MLGLD	 Crystal Bronze Shade* 001 BRSH
 Crystal Bronze Shade* 001 BRSH	 Crystal Light Chrome* 001 LTCH
 Crystal Comet Argent Light* 001 CAL	 Crystal Silver Night** 001 SINI
Crystal Silver Night** 001 SINI	Jet Hematite* 280 HEM

CRYSTAL LACQUER^{PRO}

 Crystal Ivory Cream* 001 L106S	 Crystal Powder Yellow* 001 L101
 Crystal Powder Rose* 001 L103	 Crystal Royal Red* 001 L107S
 Crystal Royal Red* 001 L107S	 Crystal Dark Red* 001 L108S
 Crystal Dark Red* 001 L108S	 Crystal Powder Blue* 001 L104
 Crystal Powder Blue* 001 L104	 Crystal Royal Blue* 001 L110S
 Crystal Royal Blue* 001 L110S	 Crystal Powder Green* 001 L102
 Crystal Powder Green* 001 L102	 Crystal Royal Green* 001 L109S
 Crystal Royal Green* 001 L109S	 Crystal Royal Blue* 001 L110S
 Crystal Royal Blue* 001 L110S	 Crystal Dark Grey* 001 L111S
 Crystal Dark Grey* 001 L111S	 Crystal Powder Grey* 001 L105
 Crystal Powder Grey* 001 L105	 Crystal Dark Grey* 001 L111S

CRYSTAL PATINA

 Crystal White Patina 001 WHIPA	 Crystal Rose Patina* 001 ROSPA
 Crystal Silver Patina* 001 SILPA	 Crystal Gold Patina* 001 GOLPA
 Crystal Gold Patina* 001 GOLPA	 Crystal Black Patina* 001 BLAPA

NUMERICAL ORDER

001 Crystal	001 METBL Crystal Metallic Blue*	215 Black Diamond	283 Provence Lavender
001 AB Crystal Aurore Boreale	001 METSH Crystal Metallic Sunshine*	217 Indian Sapphire	284 Greige
001 ANTP Crystal Antique Pink*	001 MLGLD Crystal Metallic Light Gold*	220 Smoked Topaz	285 Air Blue Opal
001 API Crystal Astral Pink	001 MOL Crystal Moonlight	221 Light Smoked Topaz	288 Dark Indigo
001 BBL Crystal Bermuda Blue**	001 PARSH Crystal Paradise Shine	223 Light Rose	289 Indian Pink
001 BLAPA Crystal Black Patina*	001 RABDK Crystal Rainbow Dark*	225 Smoky Quartz	291 Fern Green
001 BLSH Crystal Blue Shade*	001 ROGL Crystal Rose Gold*	226 Light Topaz	292 Sunflower
001 BRSH Crystal Bronze Shade*	001 ROSPA Crystal Rose Patina*	227 Light Siam	319 Vintage Rose
001 CAL Crystal Comet Argent Light*	001 SCGR Crystal Scarabaeus Green*/***	228 Olivine	327 Indian Siam ¹
001 DOR Crystal Dorado*	001 SINI Crystal Silver Night**	229 Blue Zircon	360 Erinite
001 GOLPA Crystal Gold Patina*	001 SILPA Crystal Silver Patina*	231 Yellow Opal	361 Light Azure
001 GSHA Crystal Golden Shadow	001 SSHA Crystal Silver Shade	234 White Opal	362 Light Peach
001 IRIG Crystal Iridescent Green*	001 VL Crystal Vitrail Light**	238 Chrysolite	371 Violet
001 L101 Crystal Powder Yellow*	001 VM Crystal Vitrail Medium**	243 Capri Blue	379 Indicolite
001 L102 Crystal Powder Green*	001 WHIPA Crystal White Patina	246 Light Colorado Topaz	383 Light Grey Opal
001 L103 Crystal Powder Rose*	202 Aquamarine	253 Graphite	390 Pacific Opal
001 L104 Crystal Powder Blue*	203 Topaz	257 Blush Rose	391 Silk
001 L105 Crystal Powder Grey*	204 Amethyst	259 Tangerine	395 Rose Water Opal
001 L106S Crystal Ivory Cream*	205 Emerald	261 Light Silk	398 Cyclamen Opal
001 L107S Crystal Royal Red*	206 Sapphire	262 Rose Peach	501 Ruby
001 L108S Crystal Dark Red*	207 Montana	263 Light Turquoise	502 Fuchsia
001 L109S Crystal Royal Green*	208 Siam	265 Smoky Mauve	515 Burgundy
001 L110S Crystal Royal Blue*	209 Rose	266 Denim Blue	539 Tanzanite
001 L111S Crystal Dark Grey*	211 Light Sapphire	267 Turquoise	542 Padparadscha
001 LISH Crystal Lilac Shadow	212 Light Amethyst	277 Purple Velvet	
001 LTCH Crystal Light Chrome*	213 Jonquil	280 Jet	
001 LUMG Crystal Luminous Green*	214 Peridot	280 HEM Jet Hematite*	

ALPHABETICAL ORDER

<u>Air Blue Opal</u> [285]	<u>Crystal Luminous Green</u> [001 LUMG]*	Emerald [205]	Pacific Opal [390]
Amethyst [204]	Crystal Metallic Blue [001 METBL]*	Erinite [360]	Padparadscha [542]
Aquamarine [202]	Crystal Metallic Light Gold [001 MLGLD]*	<u>Fern Green</u> [291]	Peridot [214]
Black Diamond [215]	<u>Crystal Metallic Sunshine</u> [001 METSH]*	Fuchsia [502]	Provence Lavender [283]
Blue Zircon [229]	Crystal Moonlight [001 MOL]	<u>Greige</u> [284]	Purple Velvet [277]
<u>Blush Rose</u> [257]	<u>Crystal Paradise Shine</u> [001 PARSH]	<u>Graphite</u> [253]	Rose [209]
Burgundy [515]	Crystal Powder Blue [001 L104]*	Indian Pink [289]	<u>Rose Peach</u> [262]
Capri Blue [243]	Crystal Powder Green [001 L102]*	<u>Indian Sapphire</u> [217]	Rose Water Opal [395]
Chrysolite [238]	Crystal Powder Grey [001 L105]*	<u>Indian Siam</u> [327] ¹	Ruby [501]
Crystal [001]	Crystal Powder Rose [001 L103]*	Indicolite [379]	Sapphire [206]
Crystal Antique Pink [001 ANTP]*	Crystal Powder Yellow [001 L101]*	Jet [280]	Siam [208]
<u>Crystal Astral Pink</u> [001 API]	<u>Crystal Rainbow Dark</u> [001 RABDK]*	Jet Hematite [280 HEM]*	Silk [391]
Crystal Aurore Boreale [001 AB]	<u>Crystal Rose Gold</u> [001 ROGL]*	Jonquil [213]	Smoked Topaz [220]
Crystal Bermuda Blue [001 BBL]**	<u>Crystal Rose Patina</u> [001 ROSPA]*	Light Amethyst [212]	<u>Smoky Mauve</u> [265]
<u>Crystal Black Patina</u> [001 BLAPA]*	<u>Crystal Royal Blue</u> [001 L110S]*	Light Azure [361]	<u>Smoky Quartz</u> [225]
Crystal Blue Shade [001 BLSH]*	<u>Crystal Royal Green</u> [001 L109S]*	Light Colorado Topaz [246]	Sunflower [292]
<u>Crystal Bronze Shade</u> [001 BRSH]*	<u>Crystal Royal Red</u> [001 L107S]*	<u>Light Grey Opal</u> [383]	<u>Tangerine</u> [259]
Crystal Comet Argent Light*	<u>Crystal Scarabaeus Green</u> [001 SCGR]*/***	Light Peach [362]	Tanzanite [539]
<u>Crystal Dark Grey</u> [001 L111S]*	Crystal Silver Night [001 SINI]**	Light Rose [223]	Topaz [203]
<u>Crystal Dark Red</u> [001 L108S]*	<u>Crystal Silver Patina</u> [001 SILPA]*	Light Sapphire [211]	Turquoise [267]
Crystal Dorado [001 DOR]*	<u>Crystal Silver Shade</u> [001 SSHA]	Light Siam [227]	Vintage Rose [319]
<u>Crystal Gold Patina</u> [001 GOLPA]*	Crystal Vitrail Light [001 VL]**	Light Silk [261]	Violet [371]
Crystal Golden Shadow [001 GSHA]	Crystal Vitrail Medium [001 VM]**	Light Smoked Topaz [221]	White Opal [234]
<u>Crystal Iridescent Green</u> [001 IRIG]*	<u>Crystal White Patina</u> [001 WHIPA]	Light Topaz [226]	<u>Yellow Opal</u> [231]
<u>Crystal Ivory Cream</u> [001 L106S]*	<u>Cyclamen Opal</u> [398]	Light Turquoise [263]	
<u>Crystal Light Chrome</u> [001 LTCH]*	Dark Indigo [288]	Montana [207]	
Crystal Lilac Shadow [001 LISH]	<u>Denim Blue</u> [266]	Olivine [228]	

For details on available colors and effects for each article within the product groups, please see the product matrix of the respective item in the Collection 2016.
For color and effect samples, please see the corresponding color chart.

Classic Colors/Effects:
This color range offers a wide choice of traditional Swarovski crystal colors and effects.

Exclusive Colors/Effects:
This color range is offered exclusively by Swarovski.

The plating resistance of effects is tested according to Swarovski's plating guidelines (SWAROVSKI.COM/PROFESSIONAL). Customers are advised to carry out their own tests if customers' plating parameters diverge from Swarovski plating guidelines.

* Crystals are not resistant to plating and similar processing.
** Crystals are resistant to plating only if they are F-failed.
*** designed by Jean Paul Gaultier
¹ The color Indian Siam is available only for a specific size range. Please refer to the current Collection.

Colors and effects can appear different when illuminated with different light sources. Swarovski uses standard light source D50 for color decision and comparison. Slight changes in shades are unavoidable. Colors may vary according to cut and foiling.

The composition of Advanced Crystal is compliant with regulatory industry norms and laws regarding the restriction or prohibition of certain substances in the most relevant segments of our customers. Please note that the compliance of the crystal colors Citrine, Fireopal, Hyacinth, Light Siam, Siam and Yellow Opal vary to certain industry regulations. Those regulations are indicated with an (*) in the compliance overview. Indian Siam (option to Lt. Siam) and Tangerine (option to Sun) conform to all CLEAR-lists.

For further information please visit swarovski.com/professional

ROUND STONES

ROUND STONES

SUMMARY

1	2	3	S	
				1100 PP 0, 1
				1028 PP 2, 3, 4, 5, 6, 7, 8, 9, 10, 11, 12, 13
				1088 PP 14, 15, 16, 17, 18, 19, 20, 21, 22, 23, 24, 25, 26, 27, 28, 29, 30, 31, 32 SS 18, 19, 20, 21, 22, 24, 26, 28, 29, 30, 34, 35, 38, 39, 40, 45, 48, 50, 55 25, 50 mm
				1122 SS 17, 24, 29, 34, 39, 47 12, 14, 16, 18 mm
				1128 PP 32 SS 29, 39
				1188 SS 17, 24, 29, 39
				1201 27, 35 mm
				1318 30, 55 mm
				1357 SS 17, 29, 39 20, 50, 80 mm
				DESIGNER EDITION 1681 12, 16 mm
				DESIGNER EDITION 1695 10, 14 mm

1 Top view 2 Side view 3 Back view S Setting
 • The logo position is marked by a red dot.

ROUND STONES

1100 XERO Chaton

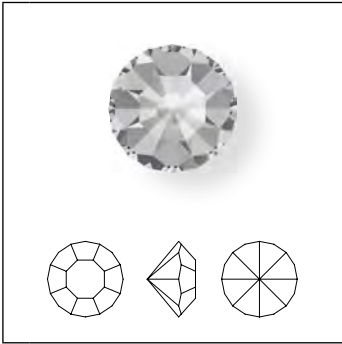

Size

PP 0

PP 1

Crystal

Crystal F (001)

Colors

Plain Colors

Black Diamond F (215)

Jet F (280)

Light Amethyst F (212)

Light Colorado Topaz F (246)

Light Peach F (362)

Light Rose F (223)

Peridot F (214)

Sapphire F (206)

Crystal Effects

Transparent Effects

Crystal AB F (001 AB)

Crystal Golden Shadow F (001 GSHA)

Crystal Silver Shade F (001 SSHA)

Color Effects

Metallic Effects

Jet Hematite F (280 HEM)

ROUND STONES

	Size												
	PP 2	PP 3	PP 4	PP 5	PP 6	PP 7	PP 8	PP 9	PP 10	PP 11	PP 12	PP 13	
1028													
Purple Velvet F (277)								■	■	■		■	
Rose F (209)		■	■	■	■	■	■	■	■	■	■	■	
Ruby F (501)								■	■	■		■	
Sapphire F (206)	■	■	■	■	■	■	■	■	■	■	■	■	
Siam F (208)		■	■	■	■			■	■	■		■	
Silk F (391)		■	■	■				■	■	■		■	
Smoked Topaz F (220)		■	■	■				■	■	■		■	
Smoky Mauve F (265)								■	■	■		■	
Smoky Quartz F (225)		■	■	■				■	■	■		■	
Tangerine F (259)		■						■	■	■		■	
Tanzanite F (539)		■	■	■	■	■	■	■	■	■	■	■	
Topaz F (203)		■	■	■				■	■	■	■	■	
Turquoise (267)								■	■	■		■	
Vintage Rose F (319)		■	■	■	■			■	■	■		■	
Violet F (371)		■	■	■	■	■	■	■	■	■	■	■	
Opal Colors													
Air Blue Opal F (285)								■	■	■		■	
Cyclamen Opal F (398)								■	■	■		■	
Light Grey Opal F (383)								■	■	■		■	
Pacific Opal F (390)								■	■	■		■	
Rose Water Opal F (395)										■		■	
White Opal F (234)		■	■	■				■	■	■		■	
Yellow Opal F (231)								■	■	■		■	
Crystal Effects													
Transparent Effects													
Crystal AB F (001 AB)	■	■	■	■	■	■	■	■	■	■	■	■	
Crystal Antique Pink F (001 ANTP)								■	■	■		■	
Crystal Blue Shade F (001 BLSH)								■	■	■		■	
Crystal Bronze Shade F (001 BRSH)								■	■	■		■	
Crystal Golden Shadow F (001 GSHA)	■	■	■	■				■	■	■		■	
Crystal Lilac Shadow F (001 LISH)								■	■	■		■	
Crystal Luminous Green F (001 LUMG)								■	■	■		■	
Crystal Moonlight F (001 MOL)		■	■	■				■	■	■		■	
Crystal Paradise Shine F (001 PARSH)								■	■	■		■	
Crystal Silver Night F (001 SINI)		■	■	■	■			■	■	■		■	
Crystal Silver Shade F (001 SSHA)	■	■	■	■				■	■	■		■	
Metallic Effects													
Crystal Dorado F (001 DOR)		■	■	■				■	■	■		■	
Crystal Iridescent Green F (001 IRIG)								■	■	■		■	
Crystal Light Chrome F (001 LTCH)								■	■	■		■	
Crystal Metallic Blue F (001 METBL)								■	■	■		■	

ROUND STONES

1028															
		Size													
		PP 2	PP 3	PP 4	PP 5	PP 6	PP 7	PP 8	PP 9	PP 10	PP 11	PP 12	PP 13		
●	Crystal Metallic Sunshine F (001 METSH)		■						■	■	■			■	
●	Crystal Metallic Light Gold F (001 MLGLD)		■	■	■				■	■	■			■	
●	Crystal Rose Gold F (001 ROGL)		■	■	■				■	■	■			■	
Color Effects															
Metallic Effects															
●	Jet Hematite (280 HEM)	■	■	■	■	■			■	■	■			■	

ROUND STONES

1088 XIRIUS Chaton

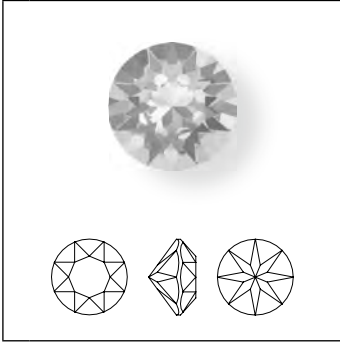

Size

PP 14 PP 15 PP 16 PP 17 PP 18 PP 19 PP 20 PP 21 PP 22 PP 23 PP 24 PP 25 PP 26 PP 27 PP 28 PP 29 PP 30 PP 31 PP 32

Crystal	
<input type="checkbox"/>	Crystal (001)
<input type="checkbox"/>	Crystal F (001)
Colors	
Plain Colors	
<input type="checkbox"/>	Amethyst F (204)
<input type="checkbox"/>	Aquamarine F (202)
<input type="checkbox"/>	Black Diamond F (215)
<input type="checkbox"/>	Blue Zircon F (229)
<input type="checkbox"/>	Blush Rose F (257)
<input type="checkbox"/>	Burgundy F (515)
<input type="checkbox"/>	Capri Blue F (243)
<input type="checkbox"/>	Chrysolite F (238)
<input type="checkbox"/>	Denim Blue F (266)
<input type="checkbox"/>	Emerald F (205)
<input type="checkbox"/>	Erinite F (360)
<input type="checkbox"/>	Fern Green F (291)
<input type="checkbox"/>	Fuchsia F (502)
<input type="checkbox"/>	Graphite F (253)
<input type="checkbox"/>	Greige F (284)
<input type="checkbox"/>	Indian Pink F (289)
<input type="checkbox"/>	Indian Sapphire F (217)
<input type="checkbox"/>	Indicolite F (379)
<input type="checkbox"/>	Jet (280)
<input type="checkbox"/>	Jet F (280)
<input type="checkbox"/>	Jonquil F (213)
<input type="checkbox"/>	Light Amethyst F (212)
<input type="checkbox"/>	Light Azore F (361)
<input type="checkbox"/>	Light Colorado Topaz F (246)
<input type="checkbox"/>	Light Peach F (362)
<input type="checkbox"/>	Light Rose F (223)
<input type="checkbox"/>	Light Sapphire F (211)
<input type="checkbox"/>	Light Siam F (227)
<input type="checkbox"/>	Light Silk F (261)
<input type="checkbox"/>	Light Smoked Topaz F (221)
<input type="checkbox"/>	Light Topaz F (226)
<input type="checkbox"/>	Light Turquoise F (263)
<input type="checkbox"/>	Montana F (207)
<input type="checkbox"/>	Padparadscha F (542)
<input type="checkbox"/>	Peridot F (214)
<input type="checkbox"/>	Provence Lavender F (283)

ROUND STONES

1088		Size	PP 14	PP 15	PP 16	PP 17	PP 18	PP 19	PP 20	PP 21	PP 22	PP 23	PP 24	PP 25	PP 26	PP 27	PP 28	PP 29	PP 30	PP 31	PP 32
	Rose F (209)		■	■	■	■	■			■			■			■				■	■
	Rose Peach F (262)		■				■			■			■							■	■
	Ruby F (501)		■				■			■			■							■	■
	Sapphire F (206)		■	■	■	■	■			■			■			■				■	■
	Siam F (208)		■				■			■			■			■				■	■
	Silk F (391)		■				■			■			■							■	■
	Smoky Mauve F (265)		■				■			■			■							■	■
	Smoked Topaz F (220)		■				■			■			■			■				■	■
	Smoky Quartz F (225)		■				■			■			■							■	■
	Tangerine F (259)		■				■			■			■							■	■
	Tanzanite F (539)		■				■			■			■							■	■
	Topaz F (203)		■				■			■			■			■				■	■
	Vintage Rose F (319)		■				■			■			■							■	■
	Violet F (371)		■				■			■			■							■	■
Opal Colors																					
	Air Blue Opal F (285)		■				■			■			■							■	■
	Cyclamen Opal F (398)		■				■			■			■							■	■
	Light Grey Opal F (383)		■				■			■			■							■	■
	Pacific Opal F (390)		■				■			■			■							■	■
	Rose Water Opal F (395)		■				■			■			■							■	■
	White Opal F (234)		■				■			■			■							■	■
	Yellow Opal F (231)		■				■			■			■							■	■
Crystal Effects																					
Transparent Effects																					
	Crystal AB F (001 AB)		■	■	■	■	■	■	■	■	■	■	■			■				■	■
	Crystal Antique Pink F (001 ANTP)		■				■			■			■							■	■
	Crystal Blue Shade F (001 BLSH)		■				■			■			■							■	■
	Crystal Golden Shadow F (001 GSHA)		■				■			■			■							■	■
	Crystal Lilac Shadow F (001 LISH)		■				■			■			■							■	■
	Crystal Luminous Green F (001 LUMG)		■				■			■			■							■	■
	Crystal Moonlight F (001 MOL)		■				■			■			■							■	■
	Crystal Paradise Shine F (001 PARSH)		■				■			■			■							■	■
	Crystal Silver Night F (001 SINI)		■				■			■			■							■	■
	Crystal Silver Shade F (001 SSHA)		■				■			■			■							■	■
Metallic Effects																					
	Crystal Dorado F (001 DOR)		■				■			■			■							■	■
	Crystal Iridescent Green F (001 IRIG)		■				■			■			■							■	■
	Crystal Light Chrome F (001 LTCH)		■				■			■			■							■	■
	Crystal Metallic Blue F (001 METBL)		■				■			■			■							■	■
	Crystal Metallic Light Gold F (001 MGLD)		■				■			■			■							■	■
	Crystal Metallic Sunshine F (001 METSH)		■				■			■			■							■	■

ROUND STONES

	Size	PP 14	PP 15	PP 16	PP 17	PP 18	PP 19	PP 20	PP 21	PP 22	PP 23	PP 24	PP 25	PP 26	PP 27	PP 28	PP 29	PP 30	PP 31	PP 32
1088																				
Crystal Rose Gold F (001 ROGL)		■				■			■			■							■	■
Crystal Scarabaeus Green*** F (001 SCGR)		■				■			■			■								■
Crystal Lacquer^{PRO}																				
Crystal Powder Blue (001 L104)									■			■								■
Crystal Powder Green (001 L102)									■			■								■
Crystal Powder Grey (001 L105)									■			■								■
Crystal Powder Rose (001 L103)									■			■								■
Crystal Powder Yellow (001 L101)									■			■								■
Crystal Patina Effects																				
Crystal Black Patina F (001 BLAPA)												■								■
Crystal Gold Patina F (001 GOLPA)												■								■
Crystal Rose Patina F (001 ROSPA)												■								■
Crystal Silver Patina F (001 SILPA)												■								■
Crystal White Patina F (001 WHIPA)												■								■
Color Effects																				
Metallic Effects																				
Jet Hematite (280 HEM)		■				■			■			■							■	■

*** designed by Jean Paul Gaultier

ROUND STONES

1088		Size	SS 18	SS 19	SS 20	SS 21	SS 22	SS 24	SS 26	SS 28	SS 29	SS 30	SS 34	SS 35	SS 38	SS 39	SS 40	SS 45	SS 48	SS 50	SS 55	25 mm	50 mm
Crystal																							
<input type="checkbox"/>	Crystal (001)		■	■				■			■		■			■							
<input type="checkbox"/>	Crystal F (001)		■	■	■	■	■	■	■	■	■	■	■	■	■	■	■	■	■	■	■	■	■
Colors																							
Plain Colors																							
<input type="checkbox"/>	Amethyst F (204)			■				■			■		■			■		■					
<input type="checkbox"/>	Aquamarine F (202)			■				■			■		■			■		■		■			
<input type="checkbox"/>	Black Diamond F (215)		■	■				■			■		■			■		■		■			
<input type="checkbox"/>	Blue Zircon F (229)			■				■			■		■			■		■					
<input type="checkbox"/>	Blush Rose F (257)							■			■		■			■		■					
<input type="checkbox"/>	Burgundy F (515)			■				■			■		■			■		■					
<input type="checkbox"/>	Capri Blue F (243)			■				■			■		■			■		■					
<input type="checkbox"/>	Chrysolite F (238)			■				■			■		■			■		■					
<input type="checkbox"/>	Denim Blue F (266)			■				■			■		■			■		■					
<input type="checkbox"/>	Emerald F (205)			■				■			■		■			■		■					
<input type="checkbox"/>	Erinite F (360)			■				■			■		■			■		■					
<input type="checkbox"/>	Fern Green F (291)			■				■			■		■			■		■					
<input type="checkbox"/>	Fuchsia F (502)			■				■			■		■			■		■					
<input type="checkbox"/>	Graphite F (253)			■				■			■		■			■		■					
<input type="checkbox"/>	Greige F (284)			■				■			■		■			■		■					
<input type="checkbox"/>	Indian Pink F (289)			■				■			■		■			■		■					
<input type="checkbox"/>	Indian Sapphire F (217)			■				■			■		■			■		■					
<input type="checkbox"/>	Indicolite F (379)			■				■			■		■			■		■					
<input type="checkbox"/>	Jet (280)			■				■			■		■			■		■					
<input type="checkbox"/>	Jonquil F (213)			■				■			■		■			■		■					
<input type="checkbox"/>	Light Amethyst F (212)			■				■			■		■			■		■					
<input type="checkbox"/>	Light Azore F (361)			■				■			■		■			■		■					
<input type="checkbox"/>	Light Colorado Topaz F (246)			■				■			■		■			■		■		■			
<input type="checkbox"/>	Light Peach F (362)			■				■			■		■			■		■					
<input type="checkbox"/>	Light Rose F (223)			■				■			■		■			■		■					
<input type="checkbox"/>	Light Sapphire F (211)			■				■			■		■			■		■					
<input type="checkbox"/>	Light Siam F (227)			■				■			■		■			■		■					
<input type="checkbox"/>	Light Silk F (261)			■				■			■		■			■		■					
<input type="checkbox"/>	Light Smoked Topaz F (221)			■				■			■		■			■		■					
<input type="checkbox"/>	Light Topaz F (226)			■				■			■		■			■		■					
<input type="checkbox"/>	Light Turquoise F (263)			■				■			■		■			■		■					
<input type="checkbox"/>	Montana F (207)			■				■			■		■			■		■					
<input type="checkbox"/>	Padparadscha F (542)			■				■			■		■			■		■					
<input type="checkbox"/>	Peridot F (214)			■				■			■		■			■		■					
<input type="checkbox"/>	Provence Lavender F (283)			■				■			■		■			■		■					
<input type="checkbox"/>	Rose F (209)			■				■			■		■			■		■					

ROUND STONES

	Size	SS 18	SS 19	SS 20	SS 21	SS 22	SS 24	SS 26	SS 28	SS 29	SS 30	SS 34	SS 35	SS 38	SS 39	SS 40	SS 45	SS 48	SS 50	SS 55	25 mm	50 mm
1088																						
Rose Peach F (262)			■				■			■		■			■							
Ruby F (501)			■				■			■		■			■							
Sapphire F (206)			■				■			■		■			■							
Siam F (208)			■				■			■		■			■		■					
Silk F (391)			■				■			■		■			■							
Smoked Topaz F (220)			■				■			■		■			■							
Smoky Mauve F (265)			■				■			■		■			■							
Smoky Quartz F (225)			■				■			■		■			■							
Tangerine F (259)			■				■			■		■			■							
Tanzanite F (539)			■				■			■		■			■							
Topaz F (203)			■				■			■		■			■							
Vintage Rose F (319)			■				■			■		■			■							
Violet F (371)			■				■			■		■			■							
Opal Colors																						
Air Blue Opal F (285)			■				■			■		■			■							
Cyclamen Opal F (398)			■				■			■		■			■							
Light Grey Opal F (383)			■				■			■		■			■							
Pacific Opal F (390)			■				■			■		■			■							
Rose Water Opal F (395)			■				■			■		■			■							
White Opal F (234)			■				■			■		■			■							
Yellow Opal F (231)			■				■			■		■			■							
Crystal Effects																						
Transparent Effects																						
Crystal AB F (001 AB)		■	■				■			■		■			■							
Crystal Antique Pink F (001 ANTP)			■				■			■		■			■							
Crystal Blue Shade F (001 BLSH)			■				■			■		■			■							
Crystal Golden Shadow F (001 GSHA)			■				■			■		■			■							
Crystal Lilac Shadow F (001 LISH)			■				■			■		■			■							
Crystal Luminous Green F (001 LUMG)			■				■			■		■			■							
Crystal Moonlight F (001 MOL)			■				■			■		■			■							
Crystal Paradise Shine F (001 PARSH)			■				■			■		■			■							
Crystal Silver Night F (001 SINI)			■				■			■		■			■							
Crystal Silver Shade F (001 SSHA)			■				■			■		■			■							
Metallic Effects																						
Crystal Dorado F (001 DOR)			■				■			■		■			■							
Crystal Iridescent Green F (001 IRIG)			■				■			■		■			■							
Crystal Light Chrome F (001 LTCH)			■				■			■		■			■							
Crystal Metallic Blue F (001 METBL)			■				■			■		■			■							
Crystal Metallic Light Gold F (001 MGLD)			■				■			■		■			■							
Crystal Metallic Sunshine F (001 METSH)			■				■			■		■			■							

ROUND STONES

1088	Size																					
	SS 18	SS 19	SS 20	SS 21	SS 22	SS 24	SS 26	SS 28	SS 29	SS 30	SS 34	SS 35	SS 38	SS 39	SS 40	SS 45	SS 48	SS 50	SS 55	25 mm	50 mm	
Crystal Rainbow Dark F (001 RABDK)									■					■								
Crystal Rose Gold F (001 ROGL)		■				■			■		■			■								
Crystal Scarabaeus Green*** F (001 SCGR)						■			■					■								
Crystal Lacquer^{PRO}																						
Crystal Powder Blue (001 L104)						■			■					■								
Crystal Powder Green (001 L102)						■			■					■								
Crystal Powder Grey (001 L105)						■			■					■								
Crystal Powder Rose (001 L103)						■			■					■								
Crystal Powder Yellow (001 L101)						■			■					■								
Crystal Dark Grey (001 L111S)									■					■								
Crystal Dark Red (001 L108S)									■					■								
Crystal Ivory Cream (001 L106S)									■					■								
Crystal Royal Blue (001 L110S)									■					■								
Crystal Royal Green (001 L109S)									■					■								
Crystal Royal Red (001 L107S)									■					■								
Crystal Patina Effects																						
Crystal Black Patina F (001 BLAPA)						■			■					■								
Crystal Gold Patina F (001 GOLPA)						■			■					■								
Crystal Rose Patina F (001 ROSPA)						■			■					■								
Crystal Silver Patina F (001 SILPA)						■			■					■								
Crystal White Patina F (001 WHIPA)						■			■					■								
Color Effects																						
Metallic Effects																						
Jet Hematite (280 HEM)		■				■			■		■			■								

*** designed by Jean Paul Gaultier

ROUND STONES

1122 Rivoli

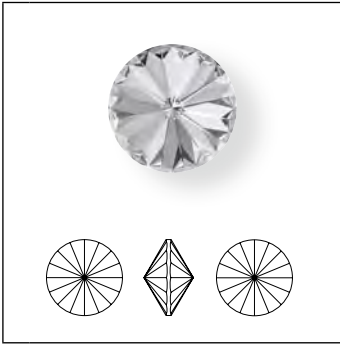

Size	SS 17	SS 24	SS 29	SS 34	SS 39	SS 47	12 mm	14 mm	16 mm	18 mm
------	-------	-------	-------	-------	-------	-------	-------	-------	-------	-------

Crystal

Crystal (001)										
Crystal F (001)	■	■	■	■	■	■	■	■	■	■

Colors

Plain Colors

Amethyst F (204)			■		■	■	■	■		
Aquamarine F (202)			■		■	■	■	■		■
Black Diamond F (215)			■		■	■	■	■		■
Blush Rose F (257)					■	■	■	■		
Chrysolite F (238)					■	■	■	■		
Denim Blue F (266)					■	■	■	■		
Emerald F (205)			■		■	■	■	■		
Fuchsia F (502)			■		■	■	■	■		
Graphite F (253)					■	■	■	■		
Jet (280)			■		■	■	■	■		
Light Amethyst F (212)			■		■	■	■	■		
Light Colorado Topaz F (246)			■		■	■	■	■		
Light Peach F (362)			■		■	■	■	■		
Light Rose F (223)			■		■	■	■	■		
Light Sapphire F (211)			■		■	■	■	■		
Light Siam F (227)			■		■	■	■	■		
Light Silk F (261)					■	■	■	■		
Light Turquoise F (263)					■	■	■	■		
Montana F (207)			■		■	■	■	■		
Olivine F (228)					■	■	■	■		
Padparadscha F (542)					■	■	■	■		
Peridot F (214)			■		■	■	■	■		
Rose F (209)			■		■	■	■	■		
Rose Peach F (262)						■	■	■		
Sapphire F (206)			■		■	■	■	■		■
Siam F (208)			■		■	■	■	■		
Silk F (391)						■	■	■		
Smoked Topaz F (220)					■	■	■	■		
Smoky Mauve F (265)					■	■	■	■		
Sunflower F (292)					■	■	■	■		
Tangerine F (259)					■	■	■	■		
Tanzanite F (539)			■		■	■	■	■		
Topaz F (203)					■	■	■	■		
Vintage Rose F (319)						■	■	■		
Violet F (371)			■		■	■	■	■		

ROUND STONES

1122		Size	SS 17	SS 24	SS 29	SS 34	SS 39	SS 47	12 mm	14 mm	16 mm	18 mm
Opal Colors												
	Yellow Opal F (231)						■	■	■	■		
Crystal Effects												
Transparent Effects												
	Crystal AB F (001 AB)		■	■	■	■	■	■	■	■	■	■
	Crystal Antique Pink F (001 ANTP)					■	■	■	■	■		
	Crystal Blue Shade F (001 BLSH)					■	■	■	■	■		
	Crystal Golden Shadow F (001 GSHA)			■		■	■	■	■	■		■
	Crystal Lilac Shadow F (001 LISH)					■	■	■	■	■		
	Crystal Luminous Green F (001 LUMG)					■	■	■	■	■		
	Crystal Paradise Shine F (001 PARSH)					■	■	■	■	■		
	Crystal Silver Night F (001 SINI)						■	■	■	■		■
	Crystal Silver Shade F (001 SSHA)			■		■	■	■	■	■		■
	Crystal Vitrail Light F (001 VL)			■		■	■	■	■	■		■
	Crystal Vitrail Medium F (001 VM)			■		■	■	■	■	■		■
Metallic Effects												
	Crystal Iridescent Green F (001 IRIG)					■	■	■	■	■		■
	Crystal Metallic Sunshine F (001 METSH)					■	■	■	■	■		
	Crystal Rainbow Dark F (001 RABDK)			■		■	■	■	■	■		
	Crystal Rose Gold F (001 ROGL)					■	■	■	■	■		
	Crystal Scarabaeus Green*** F (001 SCGR)					■	■	■	■	■		
Crystal Patina Effects												
	Crystal Black Patina F (001 BLAPA)					■	■	■	■	■		
	Crystal Gold Patina F (001 GOLPA)					■	■	■	■	■		
	Crystal Rose Patina F (001 ROSPA)					■	■	■	■	■		
	Crystal Silver Patina F (001 SILPA)					■	■	■	■	■		
	Crystal White Patina F (001 WHIPA)					■	■	■	■	■		
Crystal Lacquer^{PRO}												
	Crystal Dark Grey (001 L111S)							■	■	■		
	Crystal Dark Red (001 L108S)							■	■	■		
	Crystal Ivory Cream (001 L106S)							■	■	■		
	Crystal Royal Blue (001 L110S)							■	■	■		
	Crystal Royal Green (001 L109S)							■	■	■		
	Crystal Royal Red (001 L107S)							■	■	■		
Color Effects												
Metallic Effects												
	Jet Hematite (280 HEM)			■		■	■	■	■	■		

*** designed by Jean Paul Gaultier

ROUND STONES

1128

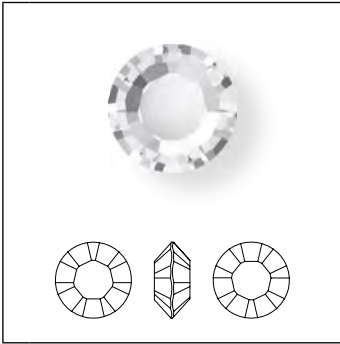

Size	PP 32	SS 29	SS 39
------	-------	-------	-------

- Crystal**
- Crystal (001)
- Colors**
- Plain Colors**
- Amethyst (204)
- Emerald (205)
- Light Amethyst (212)
- Light Sapphire (211)
- Peridot (214)
- Rose (209)
- Sapphire (206)
- Siam (208)
- Topaz (203)

1188 XIRIUS Pointed Chaton

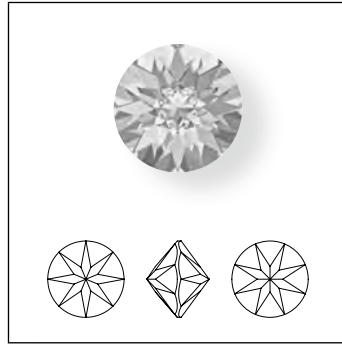

Size	SS 17	SS 24	SS 29	SS 39
------	-------	-------	-------	-------

- Crystal**
- Crystal (001)
- Crystal F (001)
- Colors**
- Plain Colors**
- Aquamarine F (202)
- Black Diamond F (215)
- Jet (280)
- Light Peach F (362)
- Light Rose F (223)
- Light Siam F (227)
- Montana F (207)
- Rose F (209)
- Crystal Effects**
- Transparent Effects**
- Crystal AB F (001 AB)
- Crystal Golden Shadow F (001 GSHA)
- Crystal Lilac Shadow F (001 LISH)
- Crystal Luminous Green F (001 LUMG)
- Crystal Silver Shade F (001 SSHA)
- Metallic Effects**
- Crystal Iridescent Green F (001 IRIG)
- Crystal Rose Gold F (001 ROGL)
- Crystal Patina Effects**
- Crystal Black Patina F (001 BLAPA)
- Crystal Gold Patina F (001 GOLPA)
- Crystal Rose Patina F (001 ROSPA)
- Crystal Silver Patina F (001 SILPA)
- Crystal White Patina F (001 WHIPA)

ROUND STONES

1201

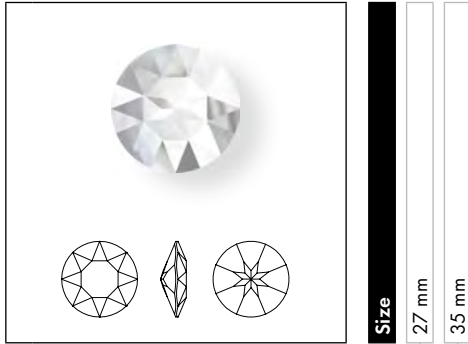

Size
27 mm
35 mm

Crystal

- Crystal (001)
- Crystal F (001)

Colors

Plain Colors

- Aquamarine F (202)

Crystal Effects

Transparent Effects

- Crystal AB F (001 AB)

1318 Flower Cut

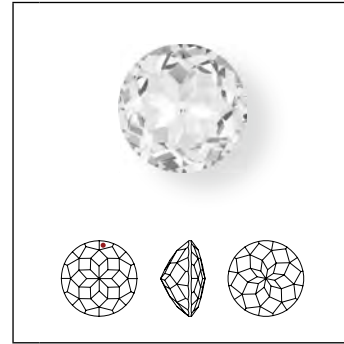

Size
30 mm
55 mm

Crystal

- Crystal CAL V SI (001 CAL V SI) ¹

1357 Brilliant Cut

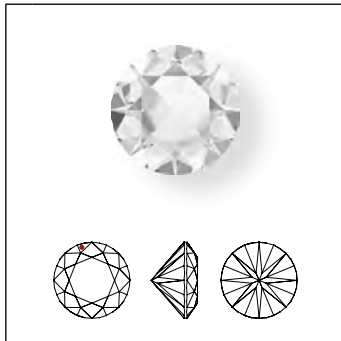

Size
SS 17
SS 29
SS 39
20 mm
50 mm
80 mm

Crystal

- Crystal (001)
- Crystal F (001)
- Crystal CAL V SI (001 CAL V SI) ¹

¹ These articles are delivered with a laser-engraved logo.

• The logo position is marked by a red dot.

ROUND STONES

DESIGNER EDITION

ATELIER MUNSTEINER FOR SWAROVSKI

Vision Round Stone

The new Vision Designer Edition marks the first ever collaboration between Swarovski and Atelier Munsteiner, a German design house renowned for its multi-award-winning gemstone cuts, fine jewelry, and sculptures. The family-owned company's third-generation master craftsmen have drawn upon many years of experience to develop this stunning crystal innovation exclusively for Swarovski.

The Vision Designer Edition combines the uncomplicated appeal of simple cuts with the playfulness of mirrored reflections. These ingeniously crafted design elements

bring to mind frozen water, with mysteriously encapsulated air bubbles forming a perfectly geometrical, flower-like shape within the crystal. It is available in three of the most popular shapes for Jewelry and Accessories – the round, square, and hexagon – offering endless design possibilities and making it ideal for use in Glamorous and Progressive creations.

It's the subtlety in the simplicity that makes this Designer Edition truly "VISIONARY."

1681 Vision Round Stone

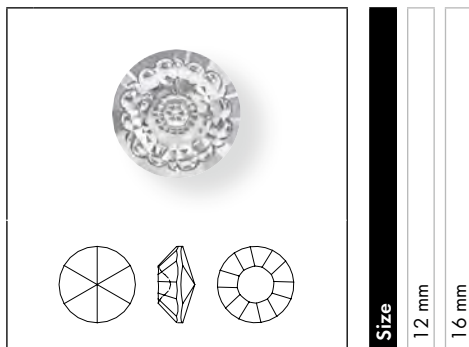

Size
12 mm
16 mm

Crystal	12 mm	16 mm
Crystal F (001)	■	■
Colors		
Plain Colors		
Aquamarine F (202)	■	■
Erinite F (360)	■	■
Light Colorado Topaz F (246)	■	■
Light Peach F (362)	■	■
Light Siam F (227)	■	■
Rose F (209)	■	■
Smoky Mauve F (265)	■	■
Tanzanite F (539)	■	■
Crystal Effects		
Transparent Effects		
Crystal Antique Pink F (001 ANTP)	■	■
Crystal Astral Pink F (001 API)	■	■
Crystal Blue Shade F (001 BLSH)	■	■
Crystal Golden Shadow F (001 GSHA)	■	■
Crystal Luminous Green F (001 LUMG)	■	■
Crystal Silver Night F (001 SINI)	■	■

1681/S

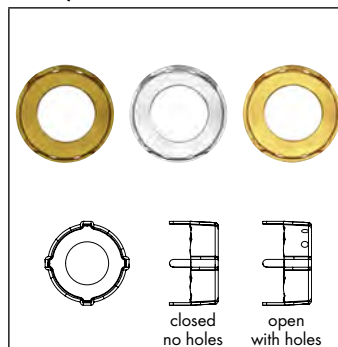

Size & color of plating
12 mm Unplated
16 mm Unplated
12 mm Rhodium
16 mm Rhodium
12 mm Gold
16 mm Gold

Ring/Hole, Back Configuration	12 mm Unplated	16 mm Unplated	12 mm Rhodium	16 mm Rhodium	12 mm Gold	16 mm Gold
00 C = No ring/hole, closed	■	■				
H2 O = 4 holes/2 each side, open			■	■	■	■

ROUND STONES

DESIGNER EDITION

THE VISION DESIGNER EDITION FAMILY



1681
12, 16 mm

chapter 01 Round Stones
p. 84



4681
14, 18 mm

chapter 02 Fancy Stones & Settings
p. 140



1681/S
12, 16 mm

chapter 01 Round Stones
p. 84



4681/S
14, 18 mm

chapter 02 Fancy Stones & Settings
p. 140



4481
12, 16 mm

chapter 02 Fancy Stones & Settings
p. 125



4481/S
12, 16 mm

chapter 02 Fancy Stones & Settings
p. 125

DESIGNER EDITIONS - DISTINCT PACKAGING

This Designer Edition will be labelled with the "Designer Edition" imprint directly on the packaging.

ROUND STONES

DESIGNER EDITION

OCEAN MYSTERIES DESIGNED
BY CÉLINE COUSTEAU

Design Story: A love for the sea runs through her veins: Céline Cousteau is a celebrated filmmaker, humanitarian, and environmentalist, and, as it so happens, the granddaughter of legendary ocean explorer Jacques Yves Cousteau. She presents her first ever crystal designs for Swarovski, inspired by one of her favorite places, the depths of the ocean. Taking inspiration from nature itself

and leaving its beauty unaltered, her stunningly life-like creatures are not only captivating and spellbinding, they also draw attention toward the mysterious, mostly unseen, and unexplored world beneath the ocean's surface on which all ocean life depends. These mysteries need to be protected for future generations, both above and below the water.

1695 Sea Urchin Round Stone partly frosted

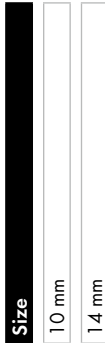
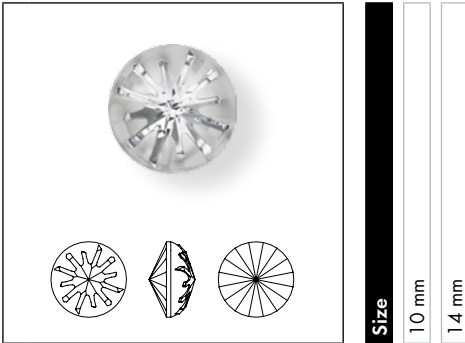

Crystal	
Crystal F (001)	<input type="checkbox"/>
Colors	
Plain Colors	
Blush Rose F (257)	<input type="checkbox"/>
Tanzanite F (539)	<input type="checkbox"/>
Opal Colors	
White Opal F (234)	<input type="checkbox"/>
Crystal Effects	
Transparent Effects	
Crystal AB F (001 AB)	<input type="checkbox"/>
Crystal Bermuda Blue F (001 BBL)	<input type="checkbox"/>
Crystal Blue Shade F (001 BLSH)	<input type="checkbox"/>
Crystal Golden Shadow F (001 GSHA)	<input type="checkbox"/>
Crystal Luminous Green F (001 LUMG)	<input type="checkbox"/>
Crystal Silver Night (001 SINI)	<input type="checkbox"/>
Crystal Silver Shade F (001 SSHA)	<input type="checkbox"/>

1695/S

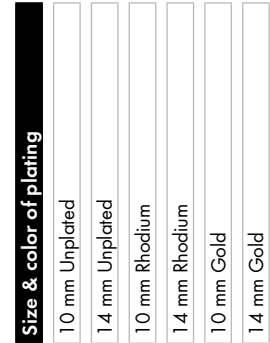
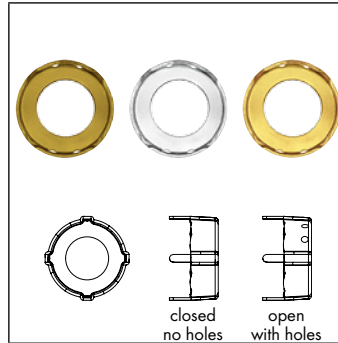

Ring/Hole, Back Configuration	
00 C = No ring/hole, closed	<input type="checkbox"/>
H2 O = 4 holes/2 each side, open	<input type="checkbox"/>

ROUND STONES

DESIGNER EDITION

THE CÉLINE COUSTEAU DESIGNER EDITION FAMILY



1695 chapter 01 Round Stones
10, 14 mm p. 86



1695/S chapter 01 Round Stones
10, 14 mm p. 86



2612 chapter 07 Flat Backs No Hotfix
6, 10, 14 mm p. 360



2612 chapter 08 Flat Backs Hotfix
6, 10, 14 mm p. 396



4195 chapter 02 Fancy Stones & Settings
14, 18, 22 mm p. 103



4195/S chapter 02 Fancy Stones & Settings
14, 18, 22 mm p. 103



6730 chapter 06 Pendants
18x11.5, 34x22 mm p. 321



6731 chapter 06 Pendants
14, 28 mm p. 322

DESIGNER EDITIONS - DISTINCT PACKAGING

This Designer Edition will be labelled with the
“Designer Edition” imprint directly on the packaging.

ROUND STONES

PRODUCT DETAILS

Article Size	Packing Unit = Minimum Order Quantity in Pieces	Average Net Weight in Grams per Packing Unit Crystal (001)	Average Gross Weight in Grams per Packing Unit Crystal (001)
1100			
PP 0	1,440	0.4	9.0
PP 1	1,440	0.6	9.1
1028			
PP 2	1,440	0.7	11.6
PP 3	1,440	1.1	11.8
PP 4	1,440	1.4	12.2
PP 5	1,440	1.8	12.6
PP 6	1,440	2.1	13.3
PP 7	1,440	2.3	13.6
PP 8	1,440	2.8	14.8
PP 9	1,440	3.4	17.7
PP 10	1,440	3.8	15.2
PP 11	1,440	4.7	16.4
PP 12	1,440	5.6	17.5
PP 13	1,440	6.7	19.2
1088			
PP 14	1,440	7.1	18.1
PP 15	1,440	7.3	19.5
PP 16	1,440	8.5	21.0
PP 17	1,440	9.0	22.4
PP 18	1,440	12.0	23.8
PP 19	1,440	12.1	25.3
PP 20	1,440	14.6	28.2
PP 21	1,440	15.8	29.6
PP 22	1,440	16.9	31.0
PP 23	1,440	19.6	33.9
PP 24	1,440	24.4	36.8
PP 25	1,440	25.4	41.1
PP 26	1,440	27.8	44.0
PP 27	1,440	30.2	46.9
PP 28	1,440	33.8	51.2
PP 29	1,440	36.2	54.1
PP 30	1,440	39.9	58.4
PP 31	1,440	49.2	64.2
PP 32	1,440	53.7	69.9
SS 18	1,440	59.2	81.4
SS 19	1,440	66.2	91.5
SS 20	720	38.6	57.0
SS 21	720	42.9	62.0
SS 22	720	46.5	66.3
SS 24	720	61.1	79.3
SS 26	360	40.5	59.1
SS 28	360	48.0	68.1
SS 29	288	47.4	71.9
SS 30	288	38.6	75.5
SS 34	144	30.2	62.1
SS 35	144	36.4	65.6
SS 38	144	44.7	73.6
SS 39	144	52.9	74.7
SS 40	144	47.1	81.5
SS 45	144	86.5	129.7
SS 48	144	118.5	169.0
SS 50	144	142.8	199.3
SS 55	72	96.5	135.7
25 mm	8	75.2	111.4
50 mm	2	127.1	181.5

ROUND STONES

Article Size	Packing Unit = Minimum Order Quantity in Pieces	Average Net Weight in Grams per Packing Unit Crystal (001)	Average Gross Weight in Grams per Packing Unit Crystal (001)
1122			
SS 17	1,440	48.7	57.2
SS 24	720	47.0	66.9
SS 29	720	77.6	103.4
SS 34	360	58.5	80.6
SS 39	144	37.1	55.2
SS 47	288	158.6	215.9
12 mm	144	99.5	142.2
14 mm	144	167.4	225.9
16 mm	144	242.7	317.2
18 mm	72	181.7	244.0
1128			
PP 32	1,440	57.9	79.9
SS 29	360	53.5	74.6
SS 39	144	49.5	69.9
1188			
SS 17	1,440	53.4	62.3
SS 24	720	73.7	82.9
SS 29	288	52.1	66.4
SS 39	144	58.3	120.6
1201			
27 mm	24	174.3	245.6
35 mm	6	70.6	115.5
1318			
30 mm	24	373.8	723.0
55 mm	10	892.3	1,372.1
1357			
SS 17	720	26.9	42.9
SS 29	360	54.3	75.6
SS 39	144	52.1	73.0
20 mm	30	148.4	383.0
50 mm	12	1,006.2	1,482.0
80 mm	4	1,078.3	1,760.0
1681			
12 mm	72	56.8	101.3
16 mm	48	84.5	127.3
1695			
10 mm	72	48.4	79.6
14 mm	36	61.4	102.7

SWAROVSKI

CERTIFICATE

H. J. HOFERT, S.L.

meets the high standards set by Swarovski® and has therefore been certified as a

SWAROVSKI

AUTHORIZED WHOLESALER

This Authorized Wholesaler offers you:

- An extensive selection of high quality Swarovski crystals
- Good product knowledge on the brand Swarovski
- Flexibility and professionalism in customer service

The staff of this Authorized Wholesaler will be happy to inform you about Swarovski and the latest brand and presentation materials.

The certification is based on a sustainable business relationship with Swarovski and on the agreement of defined standards.

01.10.2017

31.12.2017



DATE AND PLACE OF ISSUE

EXPIRY DATE

SWAROVSKI

Swarovski's suggestions for Authorized Wholesalers are recommendations based on Swarovski's actual experience, current knowledge, and the information provided by the Authorized Wholesaler. Such advice does not prevent you from carrying out your own audits, examination, and selection. The selection of an Authorized Wholesaler is solely the customer's responsibility.