



02

FANCY STONES & SETTINGS

Fancy Stones are available in numerous shapes, ranging from classical gemstone-inspired cuts to progressive trend cuts. They come in a huge assortment of different sizes and colors. Showing either a faceted or flat reverse side, Fancy Stones can be glued into pre-cast cavities or used in metal settings. Their precision-cut facets ensure the highest brilliance and lend design ideas a unique sparkle.

Settings are unplated or plated brass components, each specifically tailored to a Fancy Stone, that secure the crystal and allow for a myriad of application possibilities, including, but not limited to, sewing, soldering, and gluing.

COLORS & EFFECTS

OPEN TO SEE COLORS & EFFECTS

FANCY STONES & SETTINGS

FANCY STONES & SETTINGS

SUMMARY

1 Top view 2 Side view 3 Back view 5 Setting

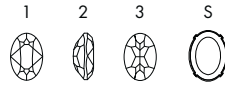
1 2 3 S

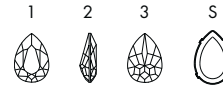
4120
6x4, 8x6, 14x10,
18x13, 25x18 mm

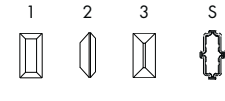
1 2 3 S

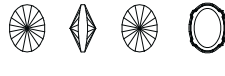
4320
6x4, 8x6, 10x7,
14x10, 18x13 mm

1 2 3 S

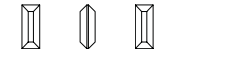
4501
4x2, 5x2, 5x2.5,
7x3, 10x5 mm

4122
8x6, 14x10.5,
18x13.5 mm

4327
30x20, 40x27 mm

4502
 3x1 mm



4127
30x22, 39x28 mm

4328
6x3.6, 8x4.8, 10x6,
13x7.8 mm

4503
 4x2, 6.3x2.4 mm

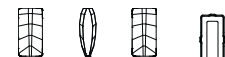

4128
6x4, 8x6, 10x8,
14x10 mm

4331
 11, 15, 20, 30 mm

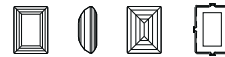

4524
12x6, 16x8,
23x11 mm

4137
 15x11 mm



4370
11x10, 15.5x14,
20x18 mm

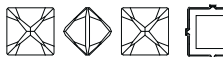

4527
8x6, 14x10,
18x13 mm

4139
 14, 20, 30 mm

4418
6, 8 mm

4547
15x5, 21x7, 24x8,
30x10 mm

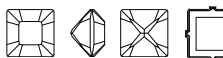
4161
15x5, 21x7,
27x9 mm

4428
 1.5, 2, 3, 4, 5,
 6, 8 mm

4565
14x10, 18x13 mm

DESIGNER EDITION

4195
 14, 18, 22 mm

4439
 14, 20, 30 mm

4568
8x6, 14x10, 18x13,
27x18 mm

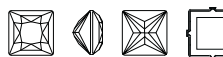

4196
23x20, 30x26 mm

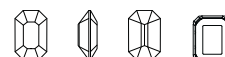

4447
6, 8, 10, 12 mm

4600
6x4, 8x6, 10x8,
12x10 mm

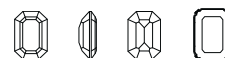
4200
11x3, 15x4,
35x9.5, 48x13 mm

4461
 8, 12, 16 mm



4610
14x10, 18x13,
20x15 mm

4224
10x8, 14x11,
23x18 mm



4470
10, 12, 18 mm

4627
27x18.5,
37x25.5 mm

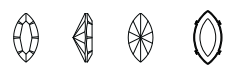

4227
32x17 mm

DESIGNER EDITION

4481
12, 16 mm

4675
 23 mm

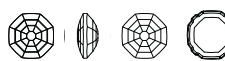

4228
4x2, 5x2.5, 6x3,
8x4, 10x5,
15x7 mm

4485
6, 10.5, 17 mm

4678
 8, 14, 23 mm

4230
14x9, 19x12,
23x15 mm

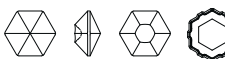
4500
3x2, 6x2, 10x3 mm

DESIGNER EDITION

4681
14, 18 mm

— ... Setting available

FANCY STONES & SETTINGS

SUMMARY



4706
7, 12, 17, 24 mm



4778
18x13.7 mm



4876
18x11.5,
30x19 mm



4717
15.5, 21.5 mm



4779
18x15.6 mm



4878
18x11.5,
30x19, mm



4722
4, 6, 8, 10 mm



4784
8, 14, 23 mm



4884
5.5x5, 6.6x6,
8.8x8, 11x10,
15.4x14 mm



4731
10x5, 14x7,
18x9 mm



4785
14, 19, 23 mm



DESIGNER EDITION

4920
23x18, 29x22.5 mm



4739
14x11, 20x16 mm



4789
14, 23, 29 mm



DESIGNER EDITION

4921
23x18, 29x22.5 mm

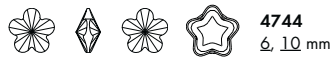

4744
6, 10 mm



4790
18x7.5, 23x10,
32x13.5 mm



DESIGNER EDITION

4922
28x24, 38x33 mm



4745
5, 10 mm



4795
14, 19, 28 mm



DESIGNER EDITION

4923
28x24, 38x33 mm

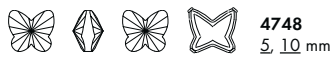

4748
5, 10 mm



4809
13x12, 17x15.5,
27x25 mm



DESIGNER EDITION

4924
23x9, 29x11.5 mm



4753
14, 18, 23 mm



4810
13x12 mm



DESIGNER EDITION

4925
23x9, 29x11.5 mm



4753/G
14, 18, 23 mm



4827
28 mm



DESIGNER EDITION

4926
14x10, 19x14 mm

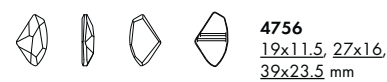

4756
19x11.5, 27x16,
39x23.5 mm



4831
5.5x5, 8.8x8,
11x10 mm



DESIGNER EDITION

4927
14x12, 19x17 mm



4757
14x8.5,
19x11.5 mm



4841
4, 6, 8 mm



4773
14x7.5, 18x9.5,
28x15 mm



4869
4, 6, 8 mm

1 Top view 2 Side view 3 Back view S Setting

— ... Setting available

FANCY STONES & SETTINGS

ARTICLE EXPLANATION & ORDERING EXAMPLE FOR SETTINGS

4120/S

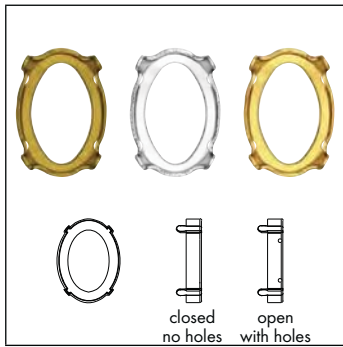

Size & color of plating
6x4 mm Unplated
8x6 mm Unplated
14x 10 mm Unplated
18x 13 mm Unplated
25x 18 mm Unplated
6x4 mm Rhodium
8x6 mm Rhodium
14x 10 mm Rhodium
18x 13 mm Rhodium
25x 18 mm Rhodium
6x4 mm Gold
8x6 mm Gold
14x 10 mm Gold
18x 13 mm Gold
25x 18 mm Gold

Ring/Hole, Back Configuration

- 00 C** = No ring/hole, closed
- H2 O** = 4 holes/2 each side, open

4120/S	6x4 mm	1	P	H2	O	Z
Base item number	Stone Size	Material type	type	Hole configuration	Back configuration	Plating
	Same digit code as Fancy Stones	1 Brass	P Non-gluing element	00 No Hole H2 Holes for sewing	C Closed O Open	Z Unplated 3 Gold ¹ H Rhodium ¹

¹ Anti nickel allergenic. Only available in the 2 hole (H2O) version.

FANCY STONES & SETTINGS

4120



Size	6x4 mm	8x6 mm	14x10 mm	18x13 mm	25x18 mm
------	--------	--------	----------	----------	----------

Crystal

- Crystal (001)
- Crystal F (001)

Colors

Plain Colors

<input type="checkbox"/> Amethyst F (204)					
<input type="checkbox"/> Aquamarine F (202)					
<input type="checkbox"/> Black Diamond F (215)					
<input type="checkbox"/> Blush Rose F (257)					
<input type="checkbox"/> Chrysolite F (238)					
<input type="checkbox"/> Emerald F (205)					
<input type="checkbox"/> Erinite F (360)					
<input type="checkbox"/> Fuchsia F (502)					
<input type="checkbox"/> Greige F (284)					
<input type="checkbox"/> Indian Sapphire F (217)					
<input type="checkbox"/> Indicolite F (379)					
<input type="checkbox"/> Jet (280)					
<input type="checkbox"/> Light Amethyst F (212)					
<input type="checkbox"/> Light Azore F (361)					
<input type="checkbox"/> Light Peach F (362)					
<input type="checkbox"/> Light Rose F (223)					
<input type="checkbox"/> Light Silk F (261)					
<input type="checkbox"/> Light Smoked Topaz F (221)					
<input type="checkbox"/> Light Turquoise F (263)					
<input type="checkbox"/> Montana F (207)					
<input type="checkbox"/> Padparadscha F (542)					
<input type="checkbox"/> Provence Lavender F (283)					
<input type="checkbox"/> Rose F (209)					
<input type="checkbox"/> Rose Peach F (262)					
<input type="checkbox"/> Sapphire F (206)					
<input type="checkbox"/> Siam F (208)					
<input type="checkbox"/> Smoky Mauve F (265)					
<input type="checkbox"/> Tanzanite F (539)					
<input type="checkbox"/> Vintage Rose F (319)					
<input type="checkbox"/> Violet F (371)					
Opal Colors					
<input type="checkbox"/> Pacific Opal F (390)					
<input type="checkbox"/> Rose Water Opal F (395)					
<input type="checkbox"/> White Opal F (234)					

FANCY STONES & SETTINGS

4122 Oval Rivoli Fancy Stone

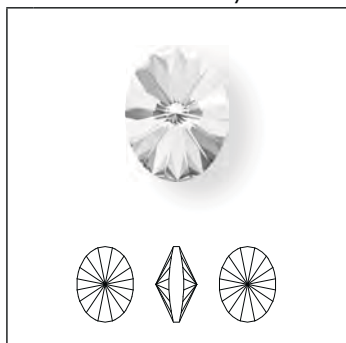

Size
8x6 mm
14x10.5 mm
18x13.5 mm

Crystal

Crystal F (001)

Colors

Plain Colors

Amethyst F (204)

Aquamarine F (202)

Emerald F (205)

Graphite F (253)

Jet (280)

Light Siam F (227)

Rose F (209)

Tanzanite F (539)

Crystal Effects

Transparent Effects

Crystal AB F (001 AB)

Crystal Antique Pink F (001 ANTP)

Crystal Blue Shade F (001 BLSH)

Crystal Golden Shadow F (001 GSHA)

Crystal Luminous Green F (001 LUMG)

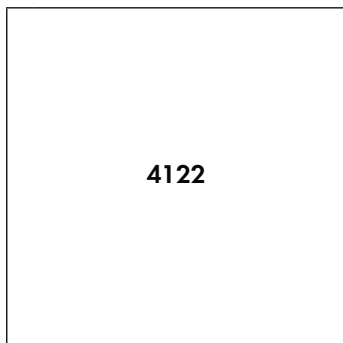

Size
8x6 mm
14x10.5 mm
18x13.5 mm

Metallic Effects

Crystal Rainbow Dark F (001 RABDK)

Crystal Lacquer^{PRO}

Crystal Dark Grey (001 L111S)

Crystal Dark Red (001 L108S)

Crystal Ivory Cream (001 L106S)

Crystal Royal Blue (001 L110S)

Crystal Royal Green (001 L109S)

Crystal Royal Red (001 L107S)

4122/S

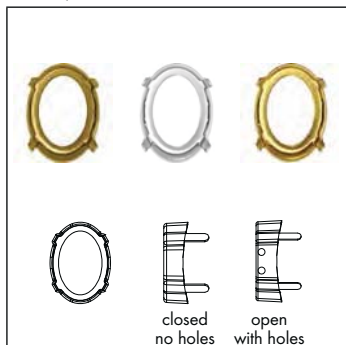

Size & color of plating
8x6 mm Unplated
14x10.5 mm Unplated
18x13.5 mm Unplated
8x6 mm Rhodium
14x10.5 mm Rhodium
18x13.5 mm Rhodium
8x6 mm Gold
14x10.5 mm Gold
18x13.5 mm Gold

Ring/Hole, Back Configuration

00 C = No ring/hole, closed

H2 O = 4 holes/2 each side, open

FANCY STONES & SETTINGS

4127

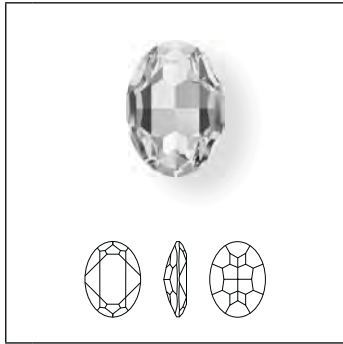

Size
30x22 mm
39x28 mm

Crystal

Crystal F (001)

Colors

Plain Colors

- Amethyst F (204)
- Aquamarine F (202)
- Black Diamond F (215)
- Blush Rose F (257)
- Burgundy F (515)
- Chrysolite F (238)
- Jet (280)
- Light Colorado Topaz F (246)
- Light Rose F (223)
- Light Turquoise F (263)
- Montana F (207)
- Smoky Mauve F (265)
- Tanzanite F (539)

Opal Colors

White Opal F (234)

Crystal Effects

Transparent Effects

- Crystal AB F (001 AB)
- Crystal Golden Shadow F (001 GSHA)
- Crystal Paradise Shine F (001 PARSH)
- Crystal Red Magma F (001 REDM)
- Crystal Silver Shade F (001 SSHA)

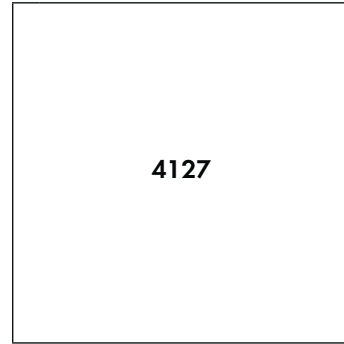

Size
30x22 mm
39x28 mm

Metallic Effects

Crystal Iridescent Green F (001 IRIG)

Crystal Lacquer^{PRO}

- Crystal Powder Blue (001 L104)
- Crystal Powder Green (001 L102)
- Crystal Powder Grey (001 L105)
- Crystal Powder Rose (001 L103)
- Crystal Powder Yellow (001 L101)
- Crystal Dark Grey (001 L111S)
- Crystal Dark Red (001 L108S)
- Crystal Ivory Cream (001 L106S)
- Crystal Royal Blue (001 L110S)
- Crystal Royal Green (001 L109S)
- Crystal Royal Red (001 L107S)

Crystal Patina Effects

- Crystal Black Patina F (001 BLAPA)
- Crystal Gold Patina F (001 GOLPA)
- Crystal Rose Patina F (001 ROSPA)
- Crystal Silver Patina F (001 SILPA)
- Crystal White Patina F (001 WHIPA)

4127/S

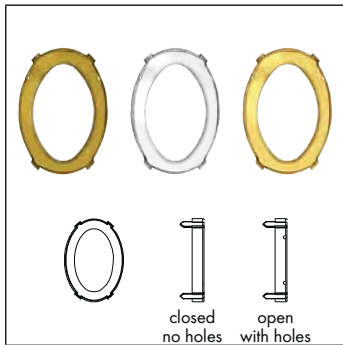

Size & color of plating
30x22 mm Unplated
39x28 mm Unplated
30x22 mm Rhodium
39x28 mm Rhodium
30x22 mm Gold
39x28 mm Gold

Ring/Hole, Back Configuration

- 00 C = No ring/hole, closed
- H2 O = 4 holes/2 each side, open

FANCY STONES & SETTINGS

4128 XILLION Oval Fancy Stone



Crystal	6x4 mm	8x6 mm	10x8 mm	14x10 mm
Crystal F (001)	■	■	■	■
Colors				
Plain Colors				
Amethyst F (204)	■	■	■	■
Aquamarine F (202)	■	■	■	■
Black Diamond F (215)	■	■	■	■
Denim Blue F (266)	■	■	■	■
Emerald F (205)	■	■	■	■
Light Amethyst F (212)	■	■	■	■
Light Rose F (223)	■	■	■	■
Montana F (207)	■	■	■	■
Rose F (209)	■	■	■	■
Siam F (208)	■	■	■	■
Crystal Effects				
Transparent Effects				
Crystal Golden Shadow F (001 GSHA)	■	■	■	■

4128/S

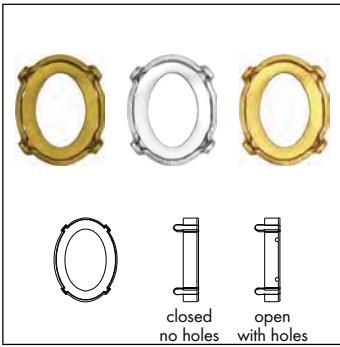

Ring/Hole, Back Configuration	6x4 mm Unplated	8x6 mm Unplated	10x8 mm Unplated	14x10 mm Unplated	6x4 mm Rhodium	8x6 mm Rhodium	10x8 mm Rhodium	14x10 mm Rhodium	6x4 mm Gold	8x6 mm Gold	10x8 mm Gold	14x10 mm Gold
00 C = No ring/hole, closed	■	■	■	■	■	■	■	■	■	■	■	■
H2 O = 4 holes/2 each side, open	■	■	■	■	■	■	■	■	■	■	■	■

FANCY STONES & SETTINGS

4137 Cosmic Oval Fancy Stone



Crystal

- Crystal (001)
- Crystal CAL V SI (001 CAL V SI)

Colors

Plain Colors

- Jet (280)

Crystal Effects

Transparent Effects

- Crystal Golden Shadow (001 GSHA)

4139 Cosmic Ring Fancy Stone

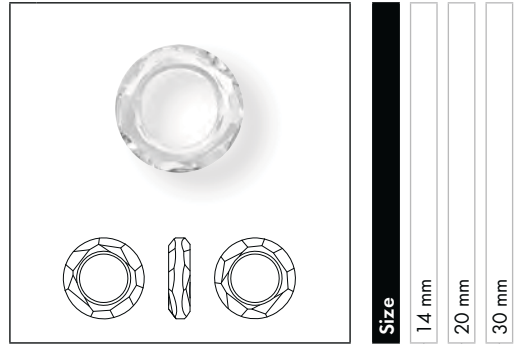

Crystal

- Crystal (001)
- Crystal CAL V SI (001 CAL V SI)

Crystal Effects

Transparent Effects

- Crystal AB (001 AB)
- Crystal Bermuda Blue (001 BBL)
- Crystal Golden Shadow (001 GSHA)
- Crystal Vitrail Light (001 VL)
- Crystal Volcano (001 VOL)

FANCY STONES & SETTINGS

4161 Long Classical Oval Fancy Stone

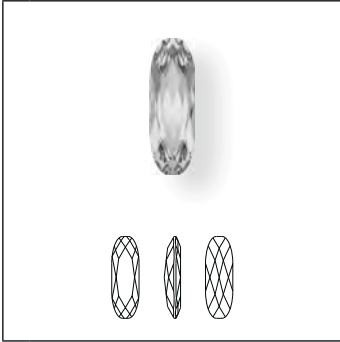

Size
15x5 mm
21x7 mm
27x9 mm

Crystal

Crystal F (001)	<input type="checkbox"/>	<input type="checkbox"/>	<input type="checkbox"/>
-----------------	--------------------------	--------------------------	--------------------------

Colors

Plain Colors

Amethyst F (204)	<input type="checkbox"/>	<input type="checkbox"/>	<input type="checkbox"/>
Aquamarine F (202)	<input type="checkbox"/>	<input type="checkbox"/>	<input type="checkbox"/>
Indicolite F (379)	<input type="checkbox"/>	<input type="checkbox"/>	<input type="checkbox"/>
Light Colorado Topaz F (246)	<input type="checkbox"/>	<input type="checkbox"/>	<input type="checkbox"/>
Light Rose F (223)	<input type="checkbox"/>	<input type="checkbox"/>	<input type="checkbox"/>
Light Turquoise F (263)	<input type="checkbox"/>	<input type="checkbox"/>	<input type="checkbox"/>
Olivine F (228)	<input type="checkbox"/>	<input type="checkbox"/>	<input type="checkbox"/>

4161/S

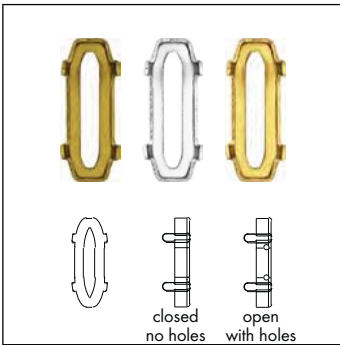

Size & color of plating
15x5 mm Unplated
21x7 mm Unplated
27x9 mm Unplated
15x5 mm Rhodium
21x7 mm Rhodium
27x9 mm Rhodium
15x5 mm Gold
21x7 mm Gold
27x9 mm Gold

Ring/Hole, Back Configuration

00 C = No ring/hole, closed	<input type="checkbox"/>	<input type="checkbox"/>	<input type="checkbox"/>	<input type="checkbox"/>	<input type="checkbox"/>	<input type="checkbox"/>	<input type="checkbox"/>	<input type="checkbox"/>	<input type="checkbox"/>
H2 O = 4 holes/2 each side, open	<input type="checkbox"/>	<input type="checkbox"/>	<input type="checkbox"/>	<input type="checkbox"/>	<input type="checkbox"/>	<input type="checkbox"/>	<input type="checkbox"/>	<input type="checkbox"/>	<input type="checkbox"/>

OCEAN MYSTERIES DESIGNED
BY CÉLINE COUSTEAU

Design Story: A love for the sea runs through her veins: Céline Cousteau is a celebrated filmmaker, humanitarian, and environmentalist, and, as it so happens, the granddaughter of legendary ocean explorer Jacques Yves Cousteau. She presents her first ever crystal designs for Swarovski, inspired by one of her favorite places, the depths of the ocean. Taking inspiration from nature itself

and leaving its beauty unaltered, her stunningly life-like creatures are not only captivating and spellbinding, they also draw attention toward the mysterious, mostly unseen, and unexplored world beneath the ocean's surface on which all ocean life depends. These mysteries need to be protected for future generations, both above and below the water.

4195 Jelly Fish Fancy Stone partly frosted

	14 mm	18 mm	22 mm
Crystal			
Crystal F (001)	■	■	■
Colors			
Plain Colors			
Blush Rose F (257)	■		
Tanzanite F (539)	■	■	■
Crystal Effects			
Transparent Effects			
Crystal AB F (001 AB)	■	■	■
Crystal Bermuda Blue F (001 BBL)	■	■	■
Crystal Blue Shade F (001 BLSH)	■	■	■
Crystal Golden Shadow F (001 GSHA)	■	■	■
Crystal Luminous Green F (001 LUMG)	■	■	■
Crystal Silver Night (001 SINI)	■	■	■
Crystal Silver Shade F (001 SSHA)	■	■	■

4195/S

	14 mm Unplated	18 mm Unplated	22 mm Unplated	14 mm Rhodium	18 mm Rhodium	22 mm Rhodium	14 mm Gold	18 mm Gold	22 mm Gold
Ring/Hole, Back Configuration									
00 C = No ring/hole, closed	■	■	■	■	■	■	■	■	■
H2 O = 4 holes/2 each side, open	■	■	■	■	■	■	■	■	■

FANCY STONES & SETTINGS

DESIGNER EDITIONTHE CÉLINE COUSTEAU
DESIGNER EDITION FAMILY**1695** chapter 01 Round Stones
10, 14 mm p. 86**1695/S** chapter 01 Round Stones
10, 14 mm p. 86**2612** chapter 07 Flat Backs No Hoflix
6, 10, 14 mm p. 360**2612** chapter 08 Flat Backs Hoflix
6, 10, 14 mm p. 396**4195** chapter 02 Fancy Stones & Settings
14, 18, 22 mm p. 103**4195/S** chapter 02 Fancy Stones & Settings
14, 18, 22 mm p. 103**6730** chapter 06 Pendants
18x11.5, 34x22 mm p. 321**6731** chapter 06 Pendants
14, 28 mm p. 322

DESIGNER EDITIONS - DISTINCT PACKAGING

This Designer Edition will be labelled with the
"Designer Edition" imprint directly on the packaging.

FANCY STONES & SETTINGS

4196 Nautilus Fancy Stone



Size

23x20 mm

30x26 mm

Crystal

Crystal F (001)

Colors

Plain Colors

Black Diamond F (215)

Light Amethyst F (212)

Light Azore F (361)

Light Colorado Topaz F (246)

Montana F (207)

Silk F (391)

4196/S

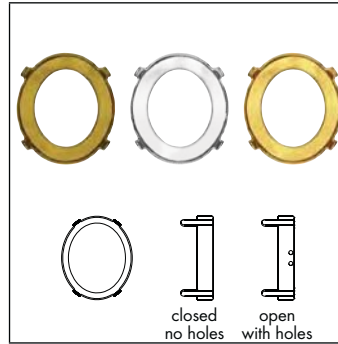

Size & color of plating

23x20 mm Unplated

30x26 mm Unplated

23x20 mm Rhodium

30x26 mm Rhodium

23x20 mm Gold

30x26 mm Gold

Ring/Hole, Back Configuration

00 C = No ring/hole, closed

H2 O = 4 holes/2 each side, open

FANCY STONES & SETTINGS

4200 Sphinx Eye Fancy Stone

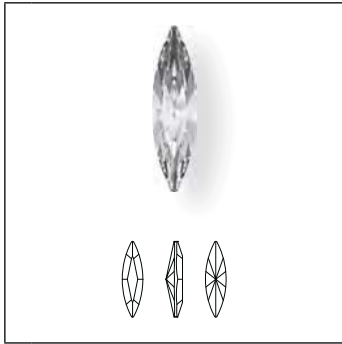

- Crystal**
- Crystal F (001)
- Colors**
- Plain Colors**
- Denim Blue F (266)
- Jet (280)
- Crystal Effects**
- Transparent Effects**
- Crystal Golden Shadow F (001 GSHA)
- Crystal Silver Shade F (001 SSHA)

Size
11x3 mm
15x4 mm
35x9.5 mm
48x13 mm

4200/S

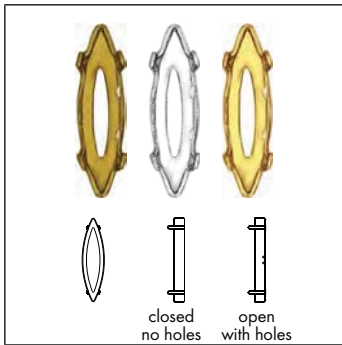

- Ring/Hole, Back Configuration**
- 00 C = No ring/hole, closed
- H2 O = 4 holes/2 each side, open

Size & color of plating
11x3 mm Unplated
15x4 mm Unplated
35x9.5 mm Unplated
48x13 mm Unplated
11x3 mm Rhodium
15x4 mm Rhodium
35x9.5 mm Rhodium
48x13 mm Rhodium
11x3 mm Gold
15x4 mm Gold
35x9.5 mm Gold
48x13 mm Gold

FANCY STONES & SETTINGS

4224 Pure Leaf Fancy Stone

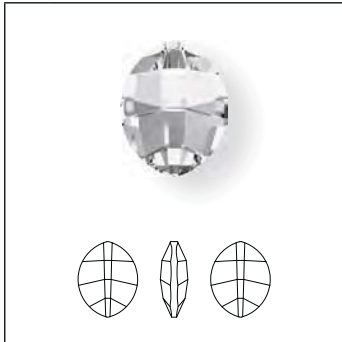

Size 10x8, 14x11 mm

4224 Pure Leaf Fancy Stone



Size 23x18 mm

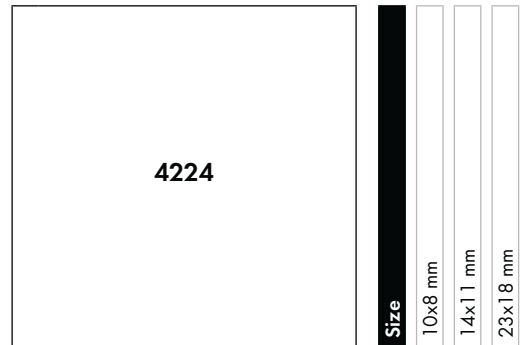

Crystal

Crystal F (001)

Colors

Plain Colors

Amethyst F (204)

Emerald F (205)

Crystal Effects

Transparent Effects

Crystal Blue Shade F (001 BLSH)

Crystal Golden Shadow F (001 GSHA)

Crystal Luminous Green F (001 LUMG)

Crystal Silver Night (001 SINI)

Crystal Patina Effects

Crystal Black Patina F (001 BLPA)

Crystal Gold Patina F (001 GOLPA)

Crystal Rose Patina F (001 ROSPA)

Crystal Silver Patina F (001 SILPA)

Crystal White Patina F (001 WHIPA)

4224/S

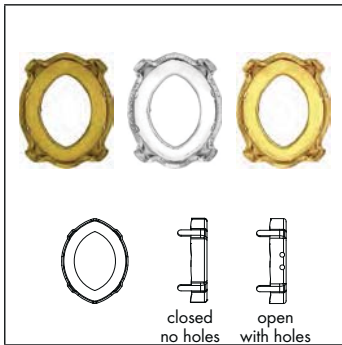

Size & color of plating

- 10x8 mm Unplated
- 14x11 mm Unplated
- 23x18 mm Unplated
- 10x8 mm Rhodium
- 14x11 mm Rhodium
- 23x18 mm Rhodium
- 10x8 mm Gold
- 14x11 mm Gold
- 23x18 mm Gold

Ring/Hole, Back Configuration

00 C = No ring/hole, closed

H2 O = 4 holes/2 each side, open

FANCY STONES & SETTINGS

4227



Size

32x17 mm

Crystal

Crystal F (001)

Colors

Plain Colors

Jet (280)

Crystal Effects

Transparent Effects

Crystal AB F (001 AB)

Crystal Golden Shadow F (001 GSHA)

Crystal Silver Shade F (001 SSHA)

4227/S

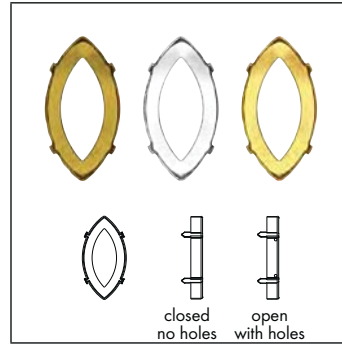

closed no holes open with holes

Ring/Hole, Back Configuration

00 C = No ring/hole, closed

H2 O = 4 holes/2 each side, open

Size & color of plating

32x17 mm Unplated

32x17 mm Rhodium

32x17 mm Gold

FANCY STONES & SETTINGS

4228 XILION Navette Fancy Stone



Size 4x2, 5x2.5 mm

4228 XILION Navette Fancy Stone

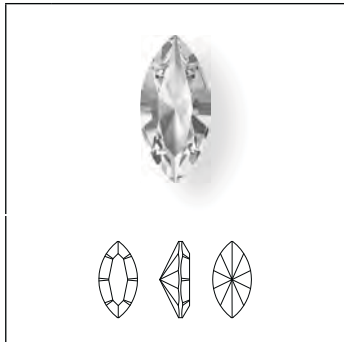

Size 6x3, 8x4, 10x5, 15x7 mm

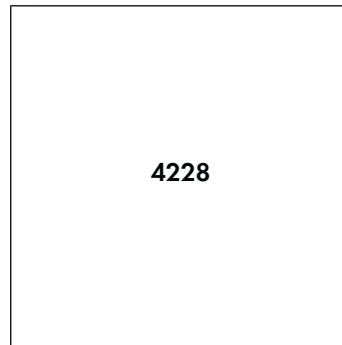

Crystal

Crystal F (001)

Colors

Plain Colors

Amethyst F (204)

Aquamarine F (202)

Black Diamond F (215)

Blush Rose F (257)

Denim Blue F (266)

Emerald F (205)

Fuchsia F (502)

Graphite F (253)

Greige F (284)

Indicolite F (379)

Jet (280)

Jonquil F (213)

Light Amethyst F (212)

Light Colorado Topaz F (246)

Light Rose F (223)

Light Sapphire F (211)

Light Siam F (227)

Light Silk F (261)

Light Turquoise F (263)

Montana F (207)

Padparadscha F (542)

Peridot F (214)

Provence Lavender F (283)

Rose F (209)

Rose Peach F (262)

Sapphire F (206)

Siam F (208)

Smoky Mauve F (265)

Smoked Topaz F (220)

Tangerine F (259)

Tanzanite F (539)

Opal Colors

Chrysolite Opal F (294)

Pacific Opal F (390)

White Opal F (234)

Size	4x2 mm	5x2.5 mm	6x3 mm	8x4 mm	10x5 mm	15x7 mm
------	--------	----------	--------	--------	---------	---------

Crystal F (001)	■	■	■	■	■	■
Amethyst F (204)	■	■	■	■	■	■
Aquamarine F (202)	■	■	■	■	■	■
Black Diamond F (215)	■	■	■	■	■	■
Blush Rose F (257)	■	■	■	■	■	■
Denim Blue F (266)	■	■	■	■	■	■
Emerald F (205)	■	■	■	■	■	■
Fuchsia F (502)	■	■	■	■	■	■
Graphite F (253)	■	■	■	■	■	■
Greige F (284)	■	■	■	■	■	■
Indicolite F (379)	■	■	■	■	■	■
Jet (280)	■	■	■	■	■	■
Jonquil F (213)	■	■	■	■	■	■
Light Amethyst F (212)	■	■	■	■	■	■
Light Colorado Topaz F (246)	■	■	■	■	■	■
Light Rose F (223)	■	■	■	■	■	■
Light Sapphire F (211)	■	■	■	■	■	■
Light Siam F (227)	■	■	■	■	■	■
Light Silk F (261)	■	■	■	■	■	■
Light Turquoise F (263)	■	■	■	■	■	■
Montana F (207)	■	■	■	■	■	■
Padparadscha F (542)	■	■	■	■	■	■
Peridot F (214)	■	■	■	■	■	■
Provence Lavender F (283)	■	■	■	■	■	■
Rose F (209)	■	■	■	■	■	■
Rose Peach F (262)	■	■	■	■	■	■
Sapphire F (206)	■	■	■	■	■	■
Siam F (208)	■	■	■	■	■	■
Smoky Mauve F (265)	■	■	■	■	■	■
Smoked Topaz F (220)	■	■	■	■	■	■
Tangerine F (259)	■	■	■	■	■	■
Tanzanite F (539)	■	■	■	■	■	■
Chrysolite Opal F (294)	■	■	■	■	■	■
Pacific Opal F (390)	■	■	■	■	■	■
White Opal F (234)	■	■	■	■	■	■

FANCY STONES & SETTINGS

4228	Size	4x2 mm	5x2.5 mm	6x3 mm	8x4 mm	10x5 mm	15x7 mm
Crystal Effects							
Transparent Effects							
Crystal AB F (001 AB)		■		■	■	■	■
Crystal Antique Pink F (001 ANTP)				■	■	■	■
Crystal Blue Shade F (001 BLSH)		■		■	■	■	■
Crystal Golden Shadow F (001 GSHA)		■		■	■	■	■
Crystal Luminous Green F (001 LUMG)				■	■	■	■
Crystal Paradise Shine F (001 PARSH)				■	■	■	■
Crystal Silver Night F (001 SINI)				■	■	■	■
Crystal Silver Shade F (001 SSHA)		■		■	■	■	■
Metallic Effects							
Crystal Iridescent Green F (001 IRIG)				■	■	■	■
Crystal Metallic Sunshine F (001 METSH)				■	■	■	■
Crystal Rose Gold F (001 ROGL)				■	■	■	■
Color Effects							
Metallic Effects							
Jet Hematite (280 HEM)		■		■	■	■	■

4228/S

<p>closed no holes open with holes</p>	Size & color of plating	5x2.5 mm Unplated	6x3 mm Unplated	8x4 mm Unplated	10x5 mm Unplated	15x7 mm Unplated	5x2.5 mm Rhodium	6x3 mm Rhodium	8x4 mm Rhodium	10x5 mm Rhodium	15x7 mm Rhodium	5x2.5 mm Gold	6x3 mm Gold	8x4 mm Gold	10x5 mm Gold	15x7 mm Gold
Ring/Hole, Back Configuration																
00 C = No ring/hole, closed		■	■	■	■	■										
H2 O = 4 holes/2 each side, open					■	■			■	■				■	■	
H2 O = 2 holes/1 each side, open		■	■	■			■	■	■	■		■	■	■	■	■

FANCY STONES & SETTINGS

4230 Lemon Fancy Stone

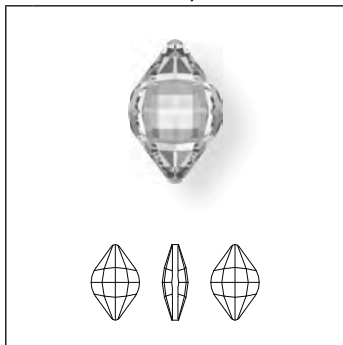

Size	14x9 mm	19x12 mm	23x15 mm
------	---------	----------	----------

Crystal

<input type="checkbox"/> Crystal F (001)	<input type="checkbox"/>	<input type="checkbox"/>	<input type="checkbox"/>
--	--------------------------	--------------------------	--------------------------

Colors

Plain Colors

<input type="checkbox"/> Amethyst F (204)	<input type="checkbox"/>	<input type="checkbox"/>	<input type="checkbox"/>
<input type="checkbox"/> Aquamarine F (202)	<input type="checkbox"/>	<input type="checkbox"/>	<input type="checkbox"/>
<input type="checkbox"/> Erinite F (360)	<input type="checkbox"/>	<input type="checkbox"/>	<input type="checkbox"/>
<input type="checkbox"/> Light Silk F (261)	<input type="checkbox"/>	<input type="checkbox"/>	<input type="checkbox"/>

Crystal Effects

Transparent Effects

<input type="checkbox"/> Crystal Antique Pink F (001 ANTP)	<input type="checkbox"/>	<input type="checkbox"/>	<input type="checkbox"/>
<input type="checkbox"/> Crystal Blue Shade F (001 BLSH)	<input type="checkbox"/>	<input type="checkbox"/>	<input type="checkbox"/>
<input type="checkbox"/> Crystal Golden Shadow F (001 GSHA)	<input type="checkbox"/>	<input type="checkbox"/>	<input type="checkbox"/>
<input type="checkbox"/> Crystal Silver Night F (001 SINI)	<input type="checkbox"/>	<input type="checkbox"/>	<input type="checkbox"/>

4230/S

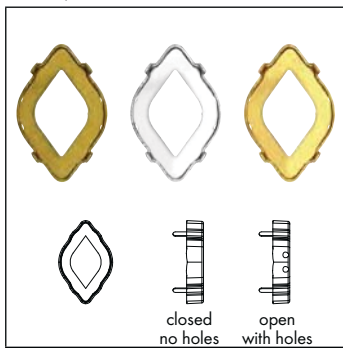

Size & color of plating	14x9 mm Unplated	19x12 mm Unplated	23x15 mm Unplated	14x9 mm Rhodium	19x12 mm Rhodium	23x15 mm Rhodium	14x9 mm Gold	19x12 mm Gold	23x15 mm Gold
-------------------------	------------------	-------------------	-------------------	-----------------	------------------	------------------	--------------	---------------	---------------

Ring/Hole, Back Configuration

<input type="checkbox"/> 00 C = No ring/hole, closed	<input type="checkbox"/>	<input type="checkbox"/>	<input type="checkbox"/>	<input type="checkbox"/>	<input type="checkbox"/>	<input type="checkbox"/>	<input type="checkbox"/>	<input type="checkbox"/>	<input type="checkbox"/>
<input type="checkbox"/> H2 O = 4 holes/2 each side, open	<input type="checkbox"/>	<input type="checkbox"/>	<input type="checkbox"/>	<input type="checkbox"/>	<input type="checkbox"/>	<input type="checkbox"/>	<input type="checkbox"/>	<input type="checkbox"/>	<input type="checkbox"/>

FANCY STONES & SETTINGS

4320



Size	6x4 mm	8x6 mm	10x7 mm	14x10 mm	18x13 mm
------	--------	--------	---------	----------	----------

Crystal

- Crystal (001)
- Crystal F (001)

Colors

Plain Colors

- Amethyst F (204)
- Aquamarine F (202)
- Black Diamond F (215)
- Blush Rose F (257)
- Denim Blue F (266)
- Emerald F (205)
- Fern Green F (291)
- Graphite F (253)
- Greige F (284)
- Jet (280)
- Light Colorado Topaz F (246)
- Light Silk F (261)
- Light Turquoise F (263)
- Montana F (207)
- Olivine F (228)
- Padparadscha F (542)
- Provence Lavender F (283)
- Rose F (209)
- Rose Peach F (262)
- Siam F (208)
- Smoky Mauve F (265)
- Tangerine F (259)
- Tanzanite F (539)
- Vintage Rose F (319)

Opal Colors

- Chrysolite Opal F (294)
- Pacific Opal F (390)
- Rose Water Opal F (395)
- White Opal F (234)
- Yellow Opal F (231)

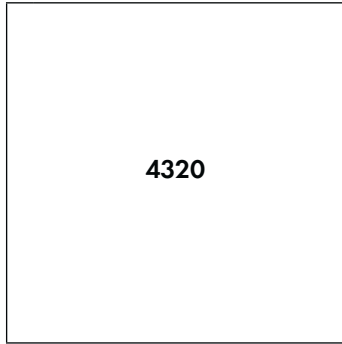

Size	6x4 mm	8x6 mm	10x7 mm	14x10 mm	18x13 mm
------	--------	--------	---------	----------	----------

Crystal Effects

Transparent Effects

- Crystal AB F (001 AB)
- Crystal Antique Pink F (001 ANTP)
- Crystal Blue Shade F (001 BLSH)
- Crystal Golden Shadow F (001 GSHA)
- Crystal Luminous Green F (001 LUMG)
- Crystal Moonlight F (001 MOL)
- Crystal Paradise Shine F (001 PARSH)
- Crystal Silver Night F (001 SINI)
- Crystal Silver Shade F (001 SSHA)

Metallic Effects

- Crystal Iridescent Green F (001 IRIG)
- Crystal Metallic Light Gold F (001 MIGLD)
- Crystal Metallic Sunshine F (001 METSH)
- Crystal Rainbow Dark F (001 RABDK)
- Crystal Rose Gold F (001 ROGL)
- Crystal Scarabaeus Green*** F (001 SCGR)

Crystal Lacquer^{PRO}

- Crystal Powder Blue (001 L104)
- Crystal Powder Green (001 L102)
- Crystal Powder Grey (001 L105)
- Crystal Powder Rose (001 L103)
- Crystal Powder Yellow (001 L101)
- Crystal Dark Grey (001 L111S)
- Crystal Dark Red (001 L108S)
- Crystal Ivory Cream (001 L106S)
- Crystal Royal Blue (001 L110S)
- Crystal Royal Green (001 L109S)
- Crystal Royal Red (001 L107S)

Crystal Patina Effects

- Crystal Black Patina F (001 BLAPA)
- Crystal Gold Patina F (001 GOLPA)
- Crystal Rose Patina F (001 ROSPA)
- Crystal Silver Patina F (001 SILPA)
- Crystal White Patina F (001 WHIPA)

*** designed by Jean Paul Gaultier

FANCY STONES & SETTINGS

4320/S

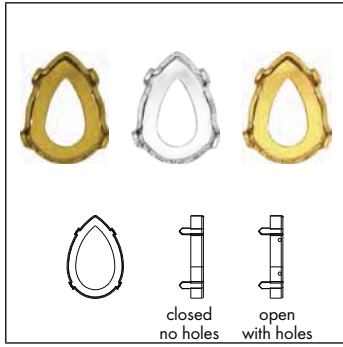

Size & color of plating

6x4 mm Unplated
8x6 mm Unplated
10x7 mm Unplated
14x10 mm Unplated
18x13 mm Unplated
6x4 mm Rhodium
8x6 mm Rhodium
10x7 mm Rhodium
14x10 mm Rhodium
18x13 mm Rhodium
6x4 mm Gold
8x6 mm Gold
10x7 mm Gold
14x10 mm Gold
18x13 mm Gold

Ring/Hole, Back Configuration

00 C = No ring/hole, closed
H2 O = 4 holes/2 each side, open
H2 O = 2 holes/1 each side, open

6x4 mm Unplated	8x6 mm Unplated	10x7 mm Unplated	14x10 mm Unplated	18x13 mm Unplated	6x4 mm Rhodium	8x6 mm Rhodium	10x7 mm Rhodium	14x10 mm Rhodium	18x13 mm Rhodium	6x4 mm Gold	8x6 mm Gold	10x7 mm Gold	14x10 mm Gold	18x13 mm Gold
■	■	■	■	■	■	■	■	■	■	■	■	■	■	■
		■	■	■			■	■	■			■	■	■
■	■				■	■				■	■			

FANCY STONES & SETTINGS

4327



Size
30x20 mm
40x27 mm

Crystal

Crystal F (001)

Colors

Plain Colors

Amethyst F (204)

Aquamarine F (202)

Black Diamond F (215)

Blush Rose F (257)

Chrysolite F (238)

Fuchsia F (502)

Graphite F (253)

Jet (280)

Light Colorado Topaz F (246)

Light Rose F (223)

Montana F (207)

Smoky Mauve F (265)

Tanzanite F (539)

Opal Colors

White Opal F (234)

Crystal Effects

Transparent Effects

Crystal AB F (001 AB)

Crystal Antique Pink F (001 ANTP)

Crystal Astral Pink F (001 API)

Crystal Golden Shadow F (001 GSHA)

Crystal Luminous Green F (001 LUMG)

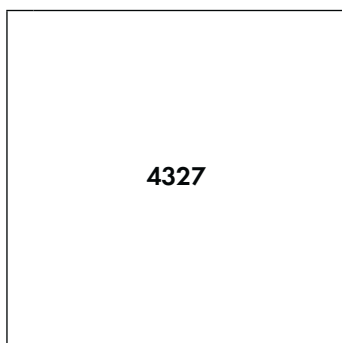

Size
30x20 mm
40x27 mm

Crystal Paradise Shine F (001 PARSH)

Crystal Red Magma F (001 REDM)

Crystal Silver Shade F (001 SSHA)

Crystal Vitrail Medium (001 VM)

Metallic Effects

Crystal Iridescent Green F (001 IRIG)

Crystal Metallic Sunshine F (001 METSH)

Crystal Rainbow Dark F (001 RABDK)

Crystal Lacquer^{PRO}

Crystal Powder Blue (001 L104)

Crystal Powder Green (001 L102)

Crystal Powder Grey (001 L105)

Crystal Powder Rose (001 L103)

Crystal Powder Yellow (001 L101)

Crystal Dark Grey (001 L111S)

Crystal Dark Red (001 L108S)

Crystal Ivory Cream (001 L106S)

Crystal Royal Blue (001 L110S)

Crystal Royal Green (001 L109S)

Crystal Royal Red (001 L107S)

Crystal Patina Effects

Crystal Black Patina F (001 BLAPA)

Crystal Gold Patina F (001 GOLPA)

Crystal Rose Patina F (001 ROSPA)

Crystal Silver Patina F (001 SILPA)

Crystal White Patina F (001 WHIPA)

4327/S

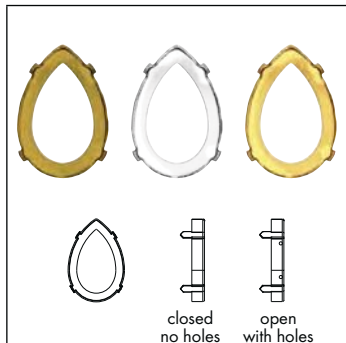

Size & color of plating
30x20 mm Unplated
40x27 mm Unplated
30x20 mm Rhodium
40x27 mm Rhodium
30x20 mm Gold
40x27 mm Gold

Ring/Hole, Back Configuration

00 C = No ring/hole, closed

H2 O = 4 holes/2 each side, open

FANCY STONES & SETTINGS

4328 XILION Pear Fancy Stone



Crystal

Crystal F (001)

Colors

Plain Colors

Amethyst F (204)

Aquamarine F (202)

Black Diamond F (215)

Emerald F (205)

Jet (280)

Light Amethyst F (212)

Light Colorado Topaz F (246)

Light Rose F (223)

Montana F (207)

Rose F (209)

Siam F (208)

Tanzanite F (539)

Crystal Effects

Transparent Effects

Crystal Golden Shadow F (001 GSHA)

Size	6x3.6 mm	8x4.8 mm	10x6 mm	13x7.8 mm
Crystal F (001)	■	■	■	■
Amethyst F (204)	■	■	■	■
Aquamarine F (202)	■	■	■	■
Black Diamond F (215)	■	■	■	■
Emerald F (205)	■	■	■	■
Jet (280)	■	■	■	■
Light Amethyst F (212)	■	■	■	■
Light Colorado Topaz F (246)	■	■	■	■
Light Rose F (223)	■	■	■	■
Montana F (207)	■	■	■	■
Rose F (209)	■	■	■	■
Siam F (208)	■	■	■	■
Tanzanite F (539)	■	■	■	■
Crystal Golden Shadow F (001 GSHA)	■	■	■	■

4328/S

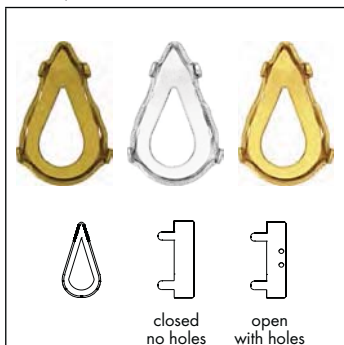

Ring/Hole, Back Configuration

00 C = No ring/hole, closed

H2 O = 4 holes/2 each side, open

Size & color of plating	6x3.6 mm Unplated	8x4.8 mm Unplated	10x6 mm Unplated	13x7.8 mm Unplated	6x3.6 mm Rhodium	8x4.8 mm Rhodium	10x6 mm Rhodium	13x7.8 mm Rhodium	6x3.6 mm Gold	8x4.8 mm Gold	10x6 mm Gold	13x7.8 mm Gold
00 C = No ring/hole, closed	■	■	■	■	■	■	■	■	■	■	■	■
H2 O = 4 holes/2 each side, open	■	■	■	■	■	■	■	■	■	■	■	■

FANCY STONES & SETTINGS

4331 Raindrop Fancy Stone



Size	11 mm	15 mm	20 mm	30 mm
------	-------	-------	-------	-------

Crystal	
<input type="checkbox"/>	Crystal F (001)
Colors	
Plain Colors	
<input type="checkbox"/>	Blush Rose F (257)
<input type="checkbox"/>	Denim Blue F (266)
<input type="checkbox"/>	Jet (280)
<input type="checkbox"/>	Tanzanite F (539)
Crystal Effects	
Transparent Effects	
<input type="checkbox"/>	Crystal AB F (001 AB)
<input type="checkbox"/>	Crystal Antique Pink F (001 ANTP)
<input type="checkbox"/>	Crystal Blue Shade F (001 BLSH)
<input type="checkbox"/>	Crystal Golden Shadow F (001 GSHA)
<input type="checkbox"/>	Crystal Luminous Green F (001 LUMG)
<input type="checkbox"/>	Crystal Silver Night (001 SINI)
<input type="checkbox"/>	Crystal Silver Shade F (001 SSHA)

4331/S

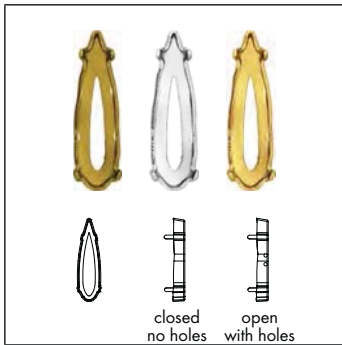

Size & color of plating	11 mm Unplated	15 mm Unplated	20 mm Unplated	30 mm Unplated	11 mm Rhodium	15 mm Rhodium	20 mm Rhodium	30 mm Rhodium	11 mm Gold	15 mm Gold	20 mm Gold	30 mm Gold
-------------------------	----------------	----------------	----------------	----------------	---------------	---------------	---------------	---------------	------------	------------	------------	------------

Ring/Hole, Back Configuration	
<input type="checkbox"/>	00 C = No ring/hole, closed
<input type="checkbox"/>	H2 O = 4 holes/2 each side, open

FANCY STONES & SETTINGS

4370



Size

11x10 mm	15.5x14 mm	20x18 mm
----------	------------	----------

Crystal

Crystal F (001)	<input type="checkbox"/>	<input type="checkbox"/>	<input type="checkbox"/>
-----------------	--------------------------	--------------------------	--------------------------

Colors

Plain Colors	<input type="checkbox"/>	<input type="checkbox"/>	<input type="checkbox"/>
--------------	--------------------------	--------------------------	--------------------------

Tanzanite (539)	<input type="checkbox"/>	<input type="checkbox"/>	<input type="checkbox"/>
-----------------	--------------------------	--------------------------	--------------------------

Crystal Effects

Transparent Effects	<input type="checkbox"/>	<input type="checkbox"/>	<input type="checkbox"/>
---------------------	--------------------------	--------------------------	--------------------------

Crystal Golden Shadow (001 GSHA)	<input type="checkbox"/>	<input type="checkbox"/>	<input type="checkbox"/>
----------------------------------	--------------------------	--------------------------	--------------------------

4370/S

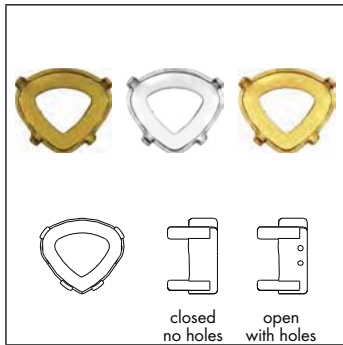

Size & color of plating

11x10 mm Unplated	<input type="checkbox"/>	<input type="checkbox"/>	<input type="checkbox"/>	<input type="checkbox"/>	<input type="checkbox"/>	<input type="checkbox"/>	<input type="checkbox"/>	<input type="checkbox"/>	<input type="checkbox"/>
15.5x14 mm Unplated	<input type="checkbox"/>	<input type="checkbox"/>	<input type="checkbox"/>	<input type="checkbox"/>	<input type="checkbox"/>	<input type="checkbox"/>	<input type="checkbox"/>	<input type="checkbox"/>	<input type="checkbox"/>
20x18 mm Unplated	<input type="checkbox"/>	<input type="checkbox"/>	<input type="checkbox"/>	<input type="checkbox"/>	<input type="checkbox"/>	<input type="checkbox"/>	<input type="checkbox"/>	<input type="checkbox"/>	<input type="checkbox"/>
11x10 mm Rhodium	<input type="checkbox"/>	<input type="checkbox"/>	<input type="checkbox"/>	<input type="checkbox"/>	<input type="checkbox"/>	<input type="checkbox"/>	<input type="checkbox"/>	<input type="checkbox"/>	<input type="checkbox"/>
15.5x14 mm Rhodium	<input type="checkbox"/>	<input type="checkbox"/>	<input type="checkbox"/>	<input type="checkbox"/>	<input type="checkbox"/>	<input type="checkbox"/>	<input type="checkbox"/>	<input type="checkbox"/>	<input type="checkbox"/>
20x18 mm Rhodium	<input type="checkbox"/>	<input type="checkbox"/>	<input type="checkbox"/>	<input type="checkbox"/>	<input type="checkbox"/>	<input type="checkbox"/>	<input type="checkbox"/>	<input type="checkbox"/>	<input type="checkbox"/>
11x10 mm Gold	<input type="checkbox"/>	<input type="checkbox"/>	<input type="checkbox"/>	<input type="checkbox"/>	<input type="checkbox"/>	<input type="checkbox"/>	<input type="checkbox"/>	<input type="checkbox"/>	<input type="checkbox"/>
15.5x14 mm Gold	<input type="checkbox"/>	<input type="checkbox"/>	<input type="checkbox"/>	<input type="checkbox"/>	<input type="checkbox"/>	<input type="checkbox"/>	<input type="checkbox"/>	<input type="checkbox"/>	<input type="checkbox"/>
20x18 mm Gold	<input type="checkbox"/>	<input type="checkbox"/>	<input type="checkbox"/>	<input type="checkbox"/>	<input type="checkbox"/>	<input type="checkbox"/>	<input type="checkbox"/>	<input type="checkbox"/>	<input type="checkbox"/>

Ring/Hole, Back Configuration

00 C = No ring/hole, closed	<input type="checkbox"/>	<input type="checkbox"/>	<input type="checkbox"/>	<input type="checkbox"/>	<input type="checkbox"/>	<input type="checkbox"/>	<input type="checkbox"/>	<input type="checkbox"/>	<input type="checkbox"/>
-----------------------------	--------------------------	--------------------------	--------------------------	--------------------------	--------------------------	--------------------------	--------------------------	--------------------------	--------------------------

H2 O = 4 holes/2 each side, open	<input type="checkbox"/>	<input type="checkbox"/>	<input type="checkbox"/>	<input type="checkbox"/>	<input type="checkbox"/>	<input type="checkbox"/>	<input type="checkbox"/>	<input type="checkbox"/>	<input type="checkbox"/>
----------------------------------	--------------------------	--------------------------	--------------------------	--------------------------	--------------------------	--------------------------	--------------------------	--------------------------	--------------------------

FANCY STONES & SETTINGS

4418 XILLION Pointed Square Fancy Stone

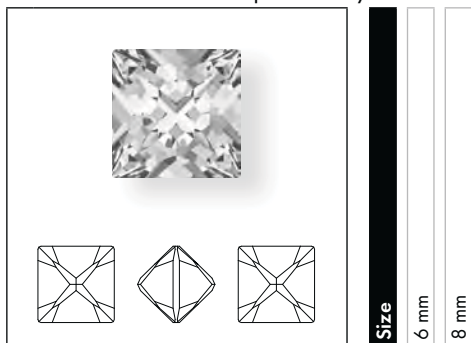

Size
6 mm
8 mm

Crystal	
Crystal (001)	■ ■
Crystal F (001)	■ ■
Colors	
Plain Colors	
Aquamarine F (202)	■ ■
Black Diamond F (215)	■ ■
Jet (280)	■ ■
Light Rose F (223)	■ ■
Montana F (207)	■ ■
Tanzanite F (539)	■ ■
Crystal Effects	
Transparent Effects	
Crystal AB F (001 AB)	■ ■
Crystal Golden Shadow F (001 GSHA)	■ ■
Crystal Lilac Shadow F (001 LISH)	■ ■
Crystal Luminous Green F (001 LUMG)	■ ■
Crystal Silver Shade F (001 SSHA)	■ ■
Metallic Effects	
Crystal Rose Gold F (001 ROGL)	■ ■
Crystal Patina Effects	
Crystal Black Patina F (001 BLAPA)	■ ■
Crystal Gold Patina F (001 GOLPA)	■ ■
Crystal Rose Patina F (001 ROSPA)	■ ■
Crystal Silver Patina F (001 SILPA)	■ ■
Crystal White Patina F (001 WHIPA)	■ ■

4418/S

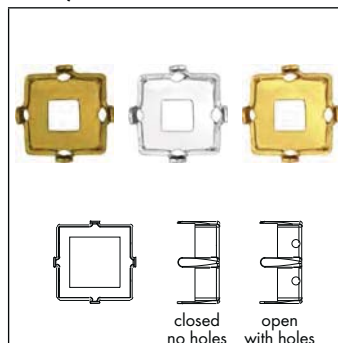

Size & color of plating
6 mm Unplated
8 mm Unplated
6 mm Rhodium
8 mm Rhodium
6 mm Gold
8 mm Gold

Ring/Hole, Back Configuration	
00 C = No ring/hole, closed	■ ■ ■ ■ ■ ■
H2 O = 4 holes/1 each side, open	■ ■ ■ ■ ■ ■

FANCY STONES & SETTINGS

4428 XILION Square Fancy Stone

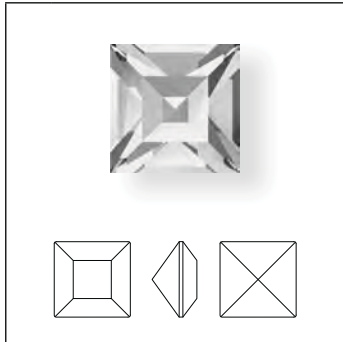

Size 1.5, 2 mm

4428 XILION Square Fancy Stone

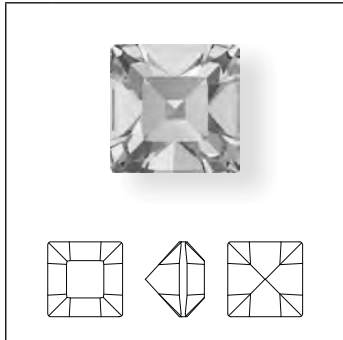

Size 3, 4 mm

4428 XILION Square Fancy Stone

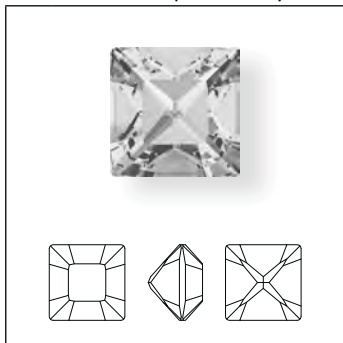

Size 5, 6, 8 mm

	1.5 mm	2 mm	3 mm	4 mm	5 mm	6 mm	8 mm
4428							
Crystal							
Crystal F (001)	■	■	■	■	■	■	■
Colors							
Plain Colors							
Amethyst F (204)	■	■	■	■	■	■	■
Aquamarine F (202)	■	■	■	■	■	■	■
Black Diamond F (215)	■	■	■	■	■	■	■
Denim Blue F (266)	■	■	■	■	■	■	■
Emerald F (205)	■	■	■	■	■	■	■
Fuchsia F (502)	■	■	■	■	■	■	■
Graphite F (253)	■	■	■	■	■	■	■
Greige F (284)	■	■	■	■	■	■	■
Indicolite F (379)	■	■	■	■	■	■	■
Jet (280)	■	■	■	■	■	■	■
Light Amethyst F (212)	■	■	■	■	■	■	■
Light Colorado Topaz F (246)	■	■	■	■	■	■	■
Light Peach F (362)	■	■	■	■	■	■	■
Light Rose F (223)	■	■	■	■	■	■	■
Light Sapphire F (211)	■	■	■	■	■	■	■
Light Siam F (227)	■	■	■	■	■	■	■
Light Smoked Topaz F (221)	■	■	■	■	■	■	■
Montana F (207)	■	■	■	■	■	■	■
Peridot F (214)	■	■	■	■	■	■	■
Rose F (209)	■	■	■	■	■	■	■
Sapphire F (206)	■	■	■	■	■	■	■
Siam F (208)	■	■	■	■	■	■	■
Smoky Mauve F (265)	■	■	■	■	■	■	■
Smoked Topaz F (220)	■	■	■	■	■	■	■
Tangerine F (259)	■	■	■	■	■	■	■
Tanzanite F (539)	■	■	■	■	■	■	■
Violet F (371)	■	■	■	■	■	■	■
Opal Colors							
White Opal F (234)	■	■	■	■	■	■	■

FANCY STONES & SETTINGS

4428		Size	1.5 mm	2 mm	3 mm	4 mm	5 mm	6 mm	8 mm
Crystal Effects									
Transparent Effects									
	Crystal AB F (001 AB)		■	■	■	■		■	■
	Crystal Antique Pink F (001 ANTP)		■	■	■	■			
	Crystal Blue Shade F (001 BLSH)		■	■	■	■			
	Crystal Golden Shadow F (001 GSHA)		■	■	■	■		■	■
	Crystal Lilac Shadow F (001 LISH)		■	■	■	■			
	Crystal Luminous Green F (001 LUMG)		■	■	■	■			
	Crystal Paradise Shine F (001 PARSH)			■	■	■		■	■
	Crystal Silver Night F (001 SINI)		■	■	■	■			
	Crystal Silver Shade F (001 SSHA)		■	■	■	■		■	■
Metallic Effects									
	Crystal Iridescent Green F (001 IRIG)			■	■	■		■	■
	Crystal Light Chrome F (001 LTCH)			■	■	■			
	Crystal Metallic Light Gold F (001 MLGLD)		■	■	■	■			
	Crystal Metallic Sunshine F (001 METSH)			■	■	■		■	■
	Crystal Rose Gold F (001 ROGL)		■	■	■	■			
Color Effects									
Metallic Effects									
	Jet Hematite (280 HEM)		■	■	■	■			

4428/S

 <p>closed no holes open with holes</p>		Size & color of plating	4 mm Unplated	5 mm Unplated	6 mm Unplated	8 mm Unplated	4 mm Rhodium	5 mm Rhodium	6 mm Rhodium	8 mm Rhodium	4 mm Gold	5 mm Gold	6 mm Gold	8 mm Gold
Ring/Hole, Back Configuration														
00 C	= No ring/hole, closed		■	■	■	■								
H2 O	= 4 holes/2 each side, open		■	■	■	■	■	■	■	■	■	■	■	■
H2 O	= 2 holes/1 each side, open		■				■				■			

FANCY STONES & SETTINGS

4439 Square Ring Fancy Stone

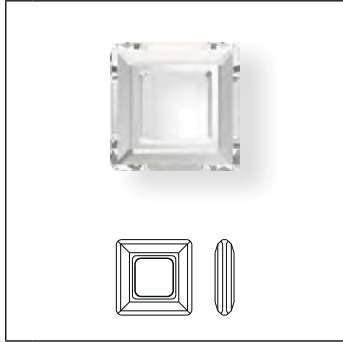

Size	14 mm	20 mm	30 mm
------	-------	-------	-------

Crystal

Crystal (001)	<input type="checkbox"/>	<input type="checkbox"/>	<input type="checkbox"/>
Crystal CAL V SI (001 CAL V SI)	<input type="checkbox"/>	<input type="checkbox"/>	<input type="checkbox"/>

Crystal Effects

Transparent Effects

Crystal AB (001 AB)	<input type="checkbox"/>	<input type="checkbox"/>	<input type="checkbox"/>
Crystal Bermuda Blue (001 BBL)	<input type="checkbox"/>	<input type="checkbox"/>	<input type="checkbox"/>
Crystal Vitrail Light (001 VL)	<input type="checkbox"/>	<input type="checkbox"/>	<input type="checkbox"/>
Crystal Volcano (001 VOL)	<input type="checkbox"/>	<input type="checkbox"/>	<input type="checkbox"/>

4447 Princess Square Fancy Stone



Size	6 mm	8 mm	10 mm	12 mm
------	------	------	-------	-------

Crystal

Crystal F (001)	<input type="checkbox"/>	<input type="checkbox"/>	<input type="checkbox"/>	<input type="checkbox"/>
-----------------	--------------------------	--------------------------	--------------------------	--------------------------

Colors

Plain Colors

Aquamarine F (202)	<input type="checkbox"/>	<input type="checkbox"/>	<input type="checkbox"/>	<input type="checkbox"/>
Tanzanite F (539)	<input type="checkbox"/>	<input type="checkbox"/>	<input type="checkbox"/>	<input type="checkbox"/>

Crystal Effects

Transparent Effects

Crystal Golden Shadow F (001 GSHA)	<input type="checkbox"/>	<input type="checkbox"/>	<input type="checkbox"/>	<input type="checkbox"/>
Crystal Silver Shade F (001 SSHA)	<input type="checkbox"/>	<input type="checkbox"/>	<input type="checkbox"/>	<input type="checkbox"/>

4447/S

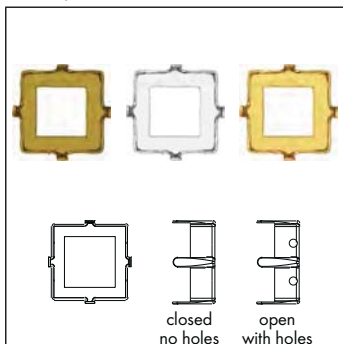

Size & color of plating	6 mm Unplated	8 mm Unplated	10 mm Unplated	12 mm Unplated	6 mm Rhodium	8 mm Rhodium	10 mm Rhodium	12 mm Rhodium	6 mm Gold	8 mm Gold	10 mm Gold	12 mm Gold
-------------------------	---------------	---------------	----------------	----------------	--------------	--------------	---------------	---------------	-----------	-----------	------------	------------

Ring/Hole, Back Configuration

00 C = No ring/hole, closed	<input type="checkbox"/>	<input type="checkbox"/>	<input type="checkbox"/>	<input type="checkbox"/>	<input type="checkbox"/>	<input type="checkbox"/>	<input type="checkbox"/>	<input type="checkbox"/>	<input type="checkbox"/>	<input type="checkbox"/>	<input type="checkbox"/>	<input type="checkbox"/>
H2 O = 4 holes/2 each side, open	<input type="checkbox"/>	<input type="checkbox"/>	<input type="checkbox"/>	<input type="checkbox"/>	<input type="checkbox"/>	<input type="checkbox"/>	<input type="checkbox"/>	<input type="checkbox"/>	<input type="checkbox"/>	<input type="checkbox"/>	<input type="checkbox"/>	<input type="checkbox"/>

FANCY STONES & SETTINGS

4461 Classical Square Fancy Stone



Size

- 8 mm
- 12 mm
- 16 mm

Crystal

Crystal F (001)

Crystal Effects

Transparent Effects

Crystal Golden Shadow F (001 GSHA)

Crystal Silver Shade F (001 SSHA)

4461/S

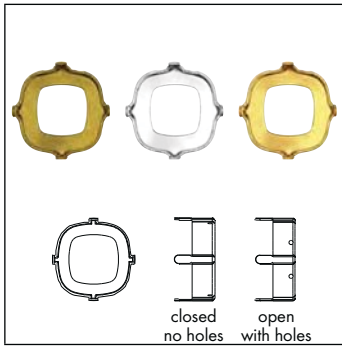

Size & color of plating

- 8 mm Unplated
- 12 mm Unplated
- 16 mm Unplated
- 8 mm Rhodium
- 12 mm Rhodium
- 16 mm Rhodium
- 8 mm Gold
- 12 mm Gold
- 16 mm Gold

Ring/Hole, Back Configuration

00 C = No ring/hole, closed

H2 O = 4 holes/2 each side, open

FANCY STONES & SETTINGS

4470



Size
10 mm
12 mm
18 mm

Crystal

- Crystal (001)
- Crystal F (001)

Colors

Plain Colors

- Aquamarine F (202)
- Black Diamond F (215)
- Blush Rose F (257)
- Burgundy F (515)
- Chrysolite F (238)
- Denim Blue F (266)
- Eriinite F (360)
- Fern Green F (291)
- Graphite F (253)
- Greige F (284)
- Indian Pink F (289)
- Jet (280)
- Indicolite F (379)
- Light Azore F (361)
- Light Colorado Topaz F (246)
- Light Peach F (362)
- Light Silk F (261)
- Light Smoked Topaz F (221)
- Light Turquoise F (263)
- Padparadscha F (542)
- Provence Lavender F (283)
- Rose Peach F (262)
- Siam F (208)
- Smoky Mauve F (265)
- Smoked Topaz F (220)
- Smoky Quartz F (225)
- Tangerine F (259)

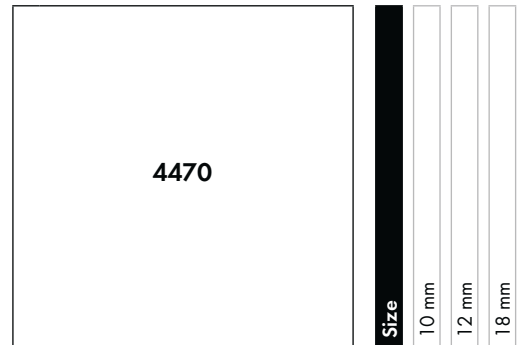

Size
10 mm
12 mm
18 mm

- Tanzanite F (539)
- Vintage Rose F (319)
- Violet F (371)

Opal Colors

- Air Blue Opal F (285)
- Chrysolite Opal F (294)
- Pacific Opal F (390)
- Rose Water Opal F (395)
- White Opal F (234)
- Yellow Opal F (231)

Crystal Effects

Transparent Effects

- Crystal Antique Pink F (001 ANTP)
- Crystal Astral Pink F (001 API)
- Crystal Blue Shade F (001 BLSH)
- Crystal Golden Shadow (001 GSHA)
- Crystal Golden Shadow F (001 GSHA)
- Crystal Lilac Shadow F (001 LISH)
- Crystal Luminous Green F (001 LUMG)
- Crystal Moonlight F (001 MOL)
- Crystal Paradise Shine F (001 PARSH)
- Crystal Silver Night F (001 SINI)
- Crystal Silver Shade (001 SSHA)
- Crystal Silver Shade F (001 SSHA)

Metallic Effects

- Crystal Iridescent Green F (001 IRIG)
- Crystal Light Chrome F (001 LTCH)
- Crystal Metallic Sunshine F (001 METSH)
- Crystal Rainbow Dark F (001 RABDK)
- Crystal Rose Gold F (001 ROGL)
- Crystal Scarabaeus Green*** F (001 SCGR)

*** designed by Jean Paul Gaultier

FANCY STONES & SETTINGS

4470

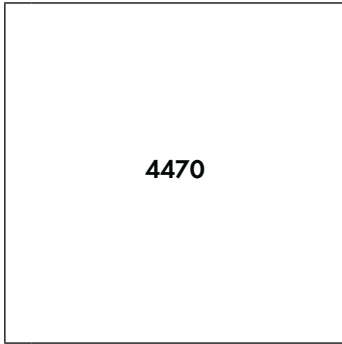

Size
10 mm
12 mm
18 mm

Crystal Lacquer^{PRO}

Crystal Powder Blue (001 L104)	■	■
Crystal Powder Green (001 L102)	■	■
Crystal Powder Grey (001 L105)	■	■
Crystal Powder Rose (001 L103)	■	■
Crystal Powder Yellow (001 L101)	■	■
Crystal Dark Grey (001 L111S)	■	■
Crystal Dark Red (001 L108S)	■	■
Crystal Ivory Cream (001 L106S)	■	■
Crystal Royal Blue (001 L110S)	■	■
Crystal Royal Green (001 L109S)	■	■
Crystal Royal Red (001 L107S)	■	■
Crystal Patina Effects		
Crystal Black Patina F (001 BLAPA)	■	■
Crystal Gold Patina F (001 GOLPA)	■	■
Crystal Rose Patina F (001 ROSPA)	■	■
Crystal Silver Patina F (001 SILPA)	■	■
Crystal White Patina F (001 WHIPA)	■	■

4470/S

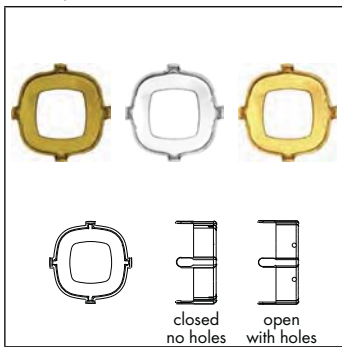

Size & color of plating
10 mm Unplated
12 mm Unplated
18 mm Unplated
10 mm Rhodium
12 mm Rhodium
18 mm Rhodium
10 mm Gold
12 mm Gold
18 mm Gold

Ring/Hole, Back Configuration

00 C = No ring/hole, closed	■	■	■	■	■	■	■	■	■
H2 O = 4 holes/2 each side, open	■	■	■	■	■	■	■	■	■

ATELIER MUNSTEINER FOR SWAROVSKI

Vision Square Fancy Stone

The new Vision Designer Edition marks the first ever collaboration between Swarovski and Atelier Munsteiner, a German design house renowned for its multi-award-winning gemstone cuts, fine jewelry, and sculptures. The family-owned company's third-generation master craftsmen have drawn upon many years of experience to develop this stunning crystal innovation exclusively for Swarovski.

The Vision Designer Edition combines the uncomplicated appeal of simple cuts with the playfulness of mirrored reflections. These ingeniously crafted design elements

bring to mind frozen water, with mysteriously encapsulated air bubbles forming a perfectly geometrical, flower-like shape within the crystal. It is available in three of the most popular shapes for Jewelry and Accessories - the round, square, and hexagon - offering endless design possibilities and making it ideal for use in Glamorous and Progressive creations.

It's the subtlety in the simplicity that makes this Designer Edition truly "VISIONARY."

4481 Vision Square Fancy Stone

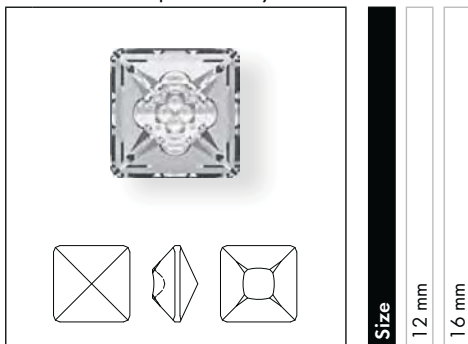

Size
12 mm
16 mm

Crystal	
Crystal F (001)	■ ■
Colors	
Plain Colors	
Aquamarine F (202)	■ ■
Erinite F (360)	■ ■
Light Colorado Topaz F (246)	■ ■
Light Peach F (362)	■ ■
Light Siam F (227)	■ ■
Rose F (209)	■ ■
Smoky Mauve F (265)	■ ■
Tanzanite F (539)	■ ■
Crystal Effects	
Transparent Effects	
Crystal Antique Pink F (001 ANTP)	■ ■
Crystal Astral Pink F (001 API)	■ ■
Crystal Blue Shade F (001 BLSH)	■ ■
Crystal Golden Shadow F (001 GSHA)	■ ■
Crystal Luminous Green F (001 LUMG)	■ ■
Crystal Silver Night F (001 SINI)	■ ■

4481/S

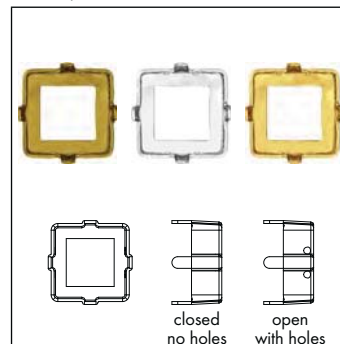

Size & color of plating
12 mm Unplated
16 mm Unplated
12 mm Rhodium
16 mm Rhodium
12 mm Gold
16 mm Gold

Ring/Hole, Back Configuration	
00 C = No ring/hole, closed	■ ■ ■ ■ ■ ■
H2 O = 4 holes/2 each side, open	■ ■ ■ ■ ■ ■

FANCY STONES & SETTINGS

DESIGNER EDITION

THE VISION DESIGNER EDITION FAMILY

**1681**
12, 16 mmchapter 01 Round Stones
p. 84**1681/S**
12, 16 mmchapter 01 Round Stones
p. 84**4481**
12, 16 mmchapter 02 Fancy Stones & Settings
p. 125**4481/S**
12, 16 mmchapter 02 Fancy Stones & Settings
p. 125**4681**
14, 18 mmchapter 02 Fancy Stones & Settings
p. 140**4681/S**
14, 18 mmchapter 02 Fancy Stones & Settings
p. 140

DESIGNER EDITIONS - DISTINCT PACKAGING

This Designer Edition will be labelled with the
 "Designer Edition" imprint directly on the packaging.

FANCY STONES & SETTINGS

4485 Twister Fancy Stone



Size	6 mm	10.5 mm	17 mm
------	------	---------	-------

Crystal

Crystal F (001)	<input type="checkbox"/>	<input type="checkbox"/>	<input type="checkbox"/>
-----------------	--------------------------	--------------------------	--------------------------

Colors

Plain Colors

Aquamarine F (202)	<input type="checkbox"/>	<input type="checkbox"/>	<input type="checkbox"/>
Graphite F (253)	<input type="checkbox"/>	<input type="checkbox"/>	<input type="checkbox"/>
Tanzanite F (539)	<input type="checkbox"/>	<input type="checkbox"/>	<input type="checkbox"/>

Crystal Effects

Transparent Effects

Crystal AB F (001 AB)	<input type="checkbox"/>	<input type="checkbox"/>	<input type="checkbox"/>
Crystal Antique Pink F (001 ANTP)	<input type="checkbox"/>	<input type="checkbox"/>	<input type="checkbox"/>
Crystal Blue Shade F (001 BLSH)	<input type="checkbox"/>	<input type="checkbox"/>	<input type="checkbox"/>
Crystal Golden Shadow F (001 GSHA)	<input type="checkbox"/>	<input type="checkbox"/>	<input type="checkbox"/>
Crystal Luminous Green F (001 LUMG)	<input type="checkbox"/>	<input type="checkbox"/>	<input type="checkbox"/>
Crystal Silver Night (001 SINI)	<input type="checkbox"/>	<input type="checkbox"/>	<input type="checkbox"/>
Crystal Silver Shade F (001 SSHA)	<input type="checkbox"/>	<input type="checkbox"/>	<input type="checkbox"/>

4485/S

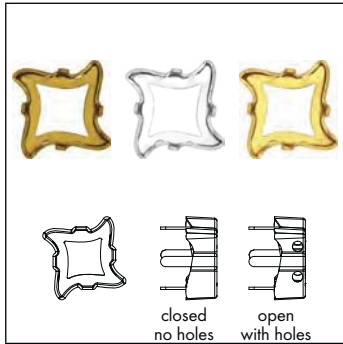

Size & color of plating	6 mm Unplated	10.5 mm Unplated	17 mm Unplated	6 mm Rhodium	10.5 mm Rhodium	17 mm Rhodium	6 mm Gold	10.5 mm Gold	17 mm Gold
-------------------------	---------------	------------------	----------------	--------------	-----------------	---------------	-----------	--------------	------------

Ring/Hole, Back Configuration

00 C = No ring/hole, closed	<input type="checkbox"/>	<input type="checkbox"/>	<input type="checkbox"/>	<input type="checkbox"/>	<input type="checkbox"/>	<input type="checkbox"/>	<input type="checkbox"/>	<input type="checkbox"/>	<input type="checkbox"/>
H2 O = 4 holes/2 each side, open	<input type="checkbox"/>	<input type="checkbox"/>	<input type="checkbox"/>	<input type="checkbox"/>	<input type="checkbox"/>	<input type="checkbox"/>	<input type="checkbox"/>	<input type="checkbox"/>	<input type="checkbox"/>

FANCY STONES & SETTINGS

4500

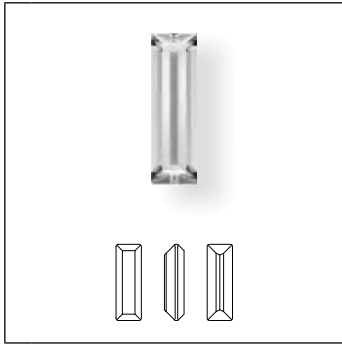

Size
3x2 mm
6x2 mm
10x3 mm

Crystal

Crystal F (001)

Colors

Plain Colors

- Amethyst F (204)
- Aquamarine F (202)
- Black Diamond F (215)
- Jet (280)
- Jonquil F (213)
- Light Rose F (223)
- Light Smoked Topaz F (221)
- Montana F (207)
- Smoked Topaz F (220)
- Topaz F (203)

4500/S

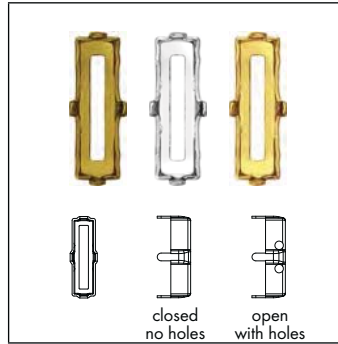

Size & color of plating
6x2 mm Unplated
10x3 mm Unplated
6x2 mm Rhodium
10x3 mm Rhodium
6x2 mm Gold
10x3 mm Gold

Ring/Hole, Back Configuration

00 C = No ring/hole, closed

H2 O = 4 holes/2 each side, open

FANCY STONES & SETTINGS

4501



Size
4x2 mm
5x2 mm
5x2.5 mm
7x3 mm
10x5 mm

Crystal

Crystal F (001)

Colors

Plain Colors

- Amethyst F (204)
- Aquamarine F (202)
- Black Diamond F (215)
- Emerald F (205)
- Erinte F (360)
- Fuchsia F (502)
- Jet (280)
- Light Amethyst F (212)
- Light Peach F (362)
- Light Rose F (223)

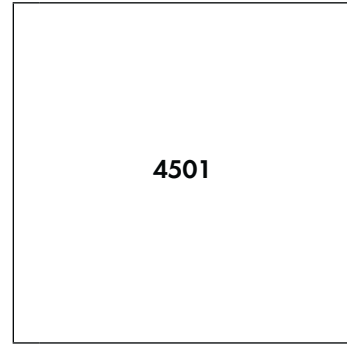

Size
4x2 mm
5x2 mm
5x2.5 mm
7x3 mm
10x5 mm

- Light Sapphire F (211)
 - Light Smoked Topaz F (221)
 - Montana F (207)
 - Rose F (209)
 - Sapphire F (206)
 - Siam F (208)
 - Smoked Topaz F (220)
 - Tanzanite F (539)
 - Topaz F (203)
 - Violet F (371)
- ### Crystal Effects
- #### Transparent Effects
- Crystal AB F (001 AB)
 - Crystal Golden Shadow F (001 GSHA)

4501/S

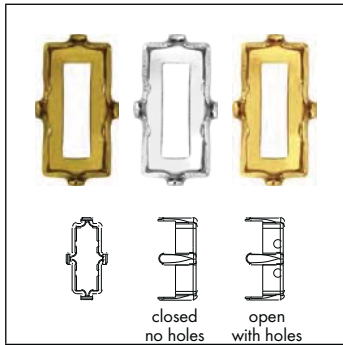

Size & color of plating
5x2.5 mm Unplated
7x3 mm Unplated
10x5 mm Unplated
5x2.5 mm Rhodium
7x3 mm Rhodium
10x5 mm Rhodium
5x2.5 mm Gold
7x3 mm Gold
10x5 mm Gold

Ring/Hole, Back Configuration

- 00 C = No ring/hole, closed
- H2 O = 4 holes/2 each side, open

FANCY STONES & SETTINGS

4502

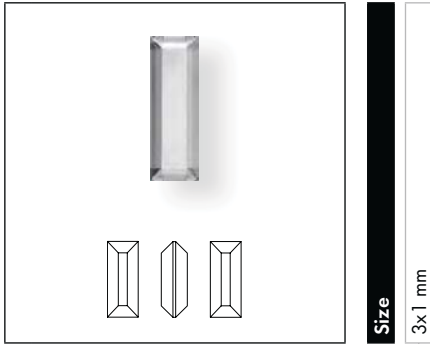

Crystal

Crystal F (001)

4503 Tapered Baguette Fancy Stone

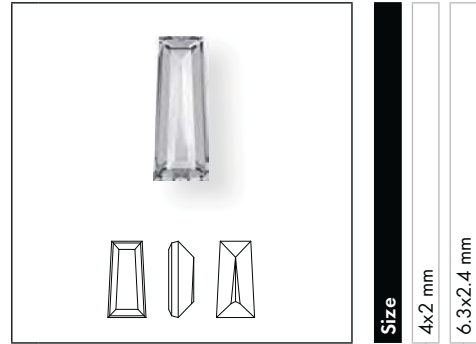

Crystal

Crystal F (001)

Colors

Plain Colors

Amethyst F (204)

Black Diamond F (215)

Jet (280)

Light Peach F (362)

Light Rose F (223)

Montana F (207)

Smoked Topaz F (220)

Crystal Effects

Transparent Effects

Crystal AB F (001 AB)

Crystal Golden Shadow F (001 GSHA)

Metallic Effects

Crystal Metallic Blue F (001 METBL)

Crystal Rose Gold F (001 ROGL)

FANCY STONES & SETTINGS

4524 Pure Baguette Fancy Stone

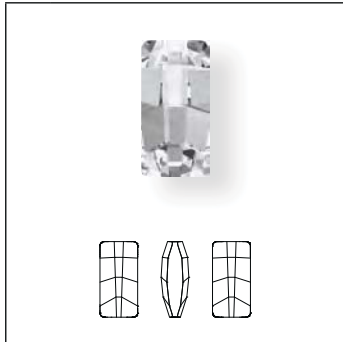

Size 12x6 mm

4524 Pure Baguette Fancy Stone

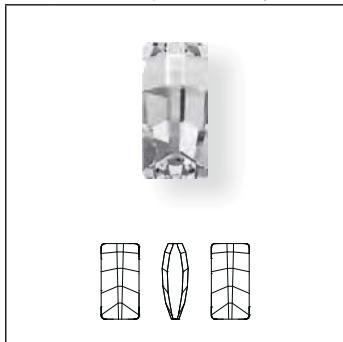

Size 16x8, 23x11 mm



Crystal	12x6 mm	16x8 mm	23x11 mm
Crystal F (001)	<input type="checkbox"/>	<input type="checkbox"/>	<input type="checkbox"/>
Colors			
Plain Colors			
Amethyst F (204)	<input type="checkbox"/>	<input type="checkbox"/>	<input type="checkbox"/>
Emerald F (205)	<input type="checkbox"/>	<input type="checkbox"/>	<input type="checkbox"/>
Crystal Effects			
Transparent Effects			
Crystal AB F (001 AB)	<input type="checkbox"/>	<input type="checkbox"/>	<input type="checkbox"/>
Crystal Blue Shade F (001 BLSH)	<input type="checkbox"/>	<input type="checkbox"/>	<input type="checkbox"/>
Crystal Golden Shadow F (001 GSHA)	<input type="checkbox"/>	<input type="checkbox"/>	<input type="checkbox"/>

4524/S

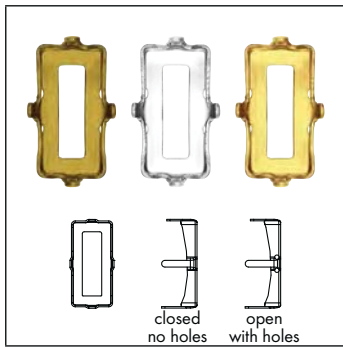

Ring/Hole, Back Configuration	12x6 mm Unplated	16x8 mm Unplated	23x11 mm Unplated	12x6 mm Rhodium	16x8 mm Rhodium	23x11 mm Rhodium	12x6 mm Gold	16x8 mm Gold	23x11 mm Gold
00 C = No ring/hole, closed	<input type="checkbox"/>	<input type="checkbox"/>	<input type="checkbox"/>	<input type="checkbox"/>	<input type="checkbox"/>	<input type="checkbox"/>	<input type="checkbox"/>	<input type="checkbox"/>	<input type="checkbox"/>
H2 O = 4 holes/2 each side, open	<input type="checkbox"/>	<input type="checkbox"/>	<input type="checkbox"/>	<input type="checkbox"/>	<input type="checkbox"/>	<input type="checkbox"/>	<input type="checkbox"/>	<input type="checkbox"/>	<input type="checkbox"/>

Size & color of plating
12x6 mm Unplated
16x8 mm Unplated
23x11 mm Unplated
12x6 mm Rhodium
16x8 mm Rhodium
23x11 mm Rhodium
12x6 mm Gold
16x8 mm Gold
23x11 mm Gold

FANCY STONES & SETTINGS

4527 Step Cut Fancy Stone



Size
8x6 mm
14x10 mm
18x13 mm

Crystal
Crystal F (001)
Colors
Plain Colors
Erinite F (360)
Light Amethyst F (212)
Montana F (207)
Smoky Quartz F (225)
Tanzanite F (539)
Crystal Effect
Transparent Effects
Crystal Golden Shadow F (001 GSHA)

4527/S

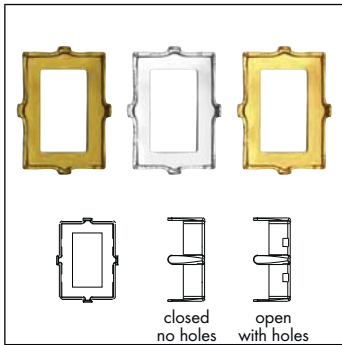

Size & color of plating
8x6 mm Unplated
14x10 mm Unplated
18x13 mm Unplated
8x6 mm Rhodium
14x10 mm Rhodium
18x13 mm Rhodium
8x6 mm Gold
14x10 mm Gold
18x13 mm Gold

Ring/Hole, Back Configuration
00 C = No ring/hole, closed
H2 O = 4 holes/2 each side, open

FANCY STONES & SETTINGS

4547 Princess Baguette Fancy Stone

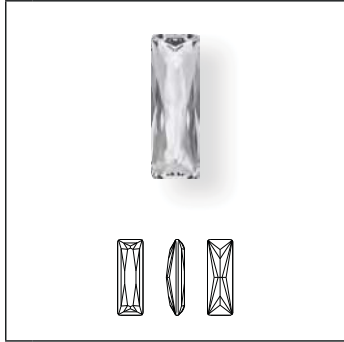

Crystal

Crystal F (001)

Colors

Plain Colors

Aquamarine F (202)

Black Diamond F (215)

Burgundy F (515)

Erinite F (360)

Jet (280)

Light Rose F (223)

Tanzanite F (539)

Crystal Effects

Transparent Effects

Crystal Golden Shadow F (001 GSHA)

Crystal Silver Shade F (001 SSHA)

Size	15x5 mm	21x7 mm	24x8 mm	30x10 mm
Crystal F (001)	■	■	■	■
Aquamarine F (202)	■	■	■	■
Black Diamond F (215)	■	■	■	■
Burgundy F (515)	■	■	■	■
Erinite F (360)	■	■	■	■
Jet (280)	■	■	■	■
Light Rose F (223)	■	■	■	■
Tanzanite F (539)	■	■	■	■
Crystal Golden Shadow F (001 GSHA)	■	■	■	■
Crystal Silver Shade F (001 SSHA)	■	■	■	■

4547/S

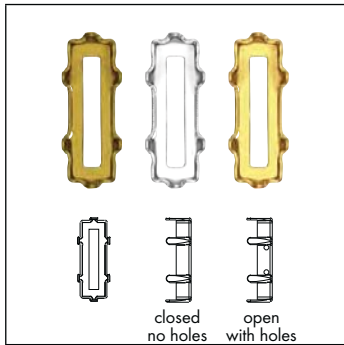

Ring/Hole, Back Configuration

00 C = No ring/hole, closed

H2 O = 4 holes/2 each side, open

Size & color of plating	15x5 mm Unplated	21x7 mm Unplated	24x8 mm Unplated	30x10 mm Unplated	15x5 mm Rhodium	21x7 mm Rhodium	24x8 mm Rhodium	30x10 mm Rhodium	15x5 mm Gold	21x7 mm Gold	24x8 mm Gold	30x10 mm Gold
00 C = No ring/hole, closed	■	■	■	■	■	■	■	■	■	■	■	■
H2 O = 4 holes/2 each side, open	■	■	■	■	■	■	■	■	■	■	■	■

FANCY STONES & SETTINGS

4565 Classical Baguette Fancy Stone



Size

14x10 mm

18x13 mm

Crystal

Crystal F (001)

Colors

Plain Colors

Aquamarine F (202)

Tanzanite (539)

Tanzanite F (539)

Crystal Effects

Transparent Effects

Crystal Golden Shadow F (001 GSHA)

4565/S

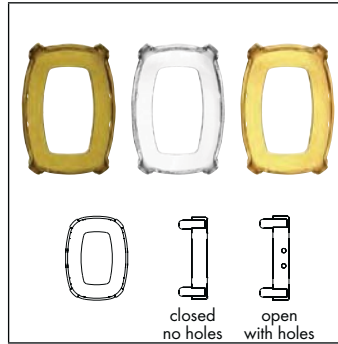

closed no holes

open with holes

Ring/Hole, Back Configuration

00 C = No ring/hole, closed

H2 O = 4 holes/2 each side, open

Size & color of plating

14x10 mm Unplated

18x13 mm Unplated

14x10 mm Rhodium

18x13 mm Rhodium

14x10 mm Gold

18x13 mm Gold

FANCY STONES & SETTINGS

4568 Cushion Fancy Stone



Size	8x6 mm	14x10 mm	18x13 mm	27x18 mm
------	--------	----------	----------	----------

Crystal

<input type="checkbox"/> Crystal F (001)	<input type="checkbox"/>	<input type="checkbox"/>	<input type="checkbox"/>	<input type="checkbox"/>
--	--------------------------	--------------------------	--------------------------	--------------------------

Colors

Plain Colors

<input type="checkbox"/> Aquamarine F (202)	<input type="checkbox"/>	<input type="checkbox"/>	<input type="checkbox"/>	<input type="checkbox"/>
<input type="checkbox"/> Denim Blue F (266)	<input type="checkbox"/>	<input type="checkbox"/>	<input type="checkbox"/>	<input type="checkbox"/>
<input type="checkbox"/> Jet (280)	<input type="checkbox"/>	<input type="checkbox"/>	<input type="checkbox"/>	<input type="checkbox"/>
<input type="checkbox"/> Light Colorado Topaz F (246)	<input type="checkbox"/>	<input type="checkbox"/>	<input type="checkbox"/>	<input type="checkbox"/>
<input type="checkbox"/> Light Siam F (227)	<input type="checkbox"/>	<input type="checkbox"/>	<input type="checkbox"/>	<input type="checkbox"/>
<input type="checkbox"/> Rose F (209)	<input type="checkbox"/>	<input type="checkbox"/>	<input type="checkbox"/>	<input type="checkbox"/>
<input type="checkbox"/> Tanzanite F (539)	<input type="checkbox"/>	<input type="checkbox"/>	<input type="checkbox"/>	<input type="checkbox"/>

Crystal Effects

Transparent Effects

<input type="checkbox"/> Crystal AB F (001 AB)	<input type="checkbox"/>	<input type="checkbox"/>	<input type="checkbox"/>	<input type="checkbox"/>
<input type="checkbox"/> Crystal Antique Pink F (001 ANTP)	<input type="checkbox"/>	<input type="checkbox"/>	<input type="checkbox"/>	<input type="checkbox"/>
<input type="checkbox"/> Crystal Golden Shadow F (001 GSHA)	<input type="checkbox"/>	<input type="checkbox"/>	<input type="checkbox"/>	<input type="checkbox"/>
<input type="checkbox"/> Crystal Lilac Shadow F (001 LISH)	<input type="checkbox"/>	<input type="checkbox"/>	<input type="checkbox"/>	<input type="checkbox"/>
<input type="checkbox"/> Crystal Luminous Green F (001 LUMG)	<input type="checkbox"/>	<input type="checkbox"/>	<input type="checkbox"/>	<input type="checkbox"/>
<input type="checkbox"/> Crystal Paradise Shine F (001 PARSH)	<input type="checkbox"/>	<input type="checkbox"/>	<input type="checkbox"/>	<input type="checkbox"/>
<input type="checkbox"/> Crystal Silver Night (001 SINI)	<input type="checkbox"/>	<input type="checkbox"/>	<input type="checkbox"/>	<input type="checkbox"/>
<input type="checkbox"/> Crystal Silver Shade F (001 SSHA)	<input type="checkbox"/>	<input type="checkbox"/>	<input type="checkbox"/>	<input type="checkbox"/>

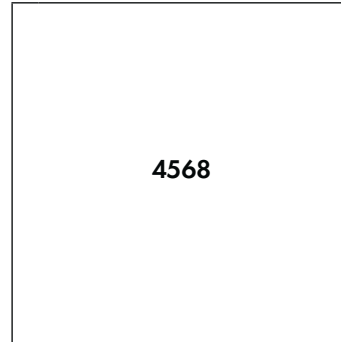

Size	8x6 mm	14x10 mm	18x13 mm	27x18 mm
------	--------	----------	----------	----------

Metallic Effects

<input type="checkbox"/> Crystal Iridescent Green (001 IRIG)	<input type="checkbox"/>	<input type="checkbox"/>	<input type="checkbox"/>	<input type="checkbox"/>
<input type="checkbox"/> Crystal Iridescent Green F (001 IRIG)	<input type="checkbox"/>	<input type="checkbox"/>	<input type="checkbox"/>	<input type="checkbox"/>

Crystal Patina Effects

<input type="checkbox"/> Crystal Black Patina F (001 BLAPA)	<input type="checkbox"/>	<input type="checkbox"/>	<input type="checkbox"/>	<input type="checkbox"/>
<input type="checkbox"/> Crystal Gold Patina F (001 GOLPA)	<input type="checkbox"/>	<input type="checkbox"/>	<input type="checkbox"/>	<input type="checkbox"/>
<input type="checkbox"/> Crystal Rose Patina F (001 ROSPA)	<input type="checkbox"/>	<input type="checkbox"/>	<input type="checkbox"/>	<input type="checkbox"/>
<input type="checkbox"/> Crystal Silver Patina F (001 SILPA)	<input type="checkbox"/>	<input type="checkbox"/>	<input type="checkbox"/>	<input type="checkbox"/>
<input type="checkbox"/> Crystal White Patina F (001 WHIPA)	<input type="checkbox"/>	<input type="checkbox"/>	<input type="checkbox"/>	<input type="checkbox"/>

4568/S

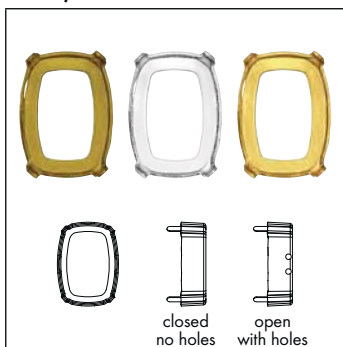

Size & color of plating	8x6 mm Unplated	14x10 mm Unplated	18x13 mm Unplated	27x18 mm Unplated	8x6 mm Rhodium	14x10 mm Rhodium	18x13 mm Rhodium	27x18 mm Rhodium	8x6 mm Gold	14x10 mm Gold	18x13 mm Gold	27x18 mm Gold
-------------------------	-----------------	-------------------	-------------------	-------------------	----------------	------------------	------------------	------------------	-------------	---------------	---------------	---------------

Ring/Hole, Back Configuration

<input type="checkbox"/> 00 C = No ring/hole, closed	<input type="checkbox"/>	<input type="checkbox"/>	<input type="checkbox"/>	<input type="checkbox"/>	<input type="checkbox"/>	<input type="checkbox"/>	<input type="checkbox"/>	<input type="checkbox"/>	<input type="checkbox"/>	<input type="checkbox"/>	<input type="checkbox"/>	<input type="checkbox"/>
<input type="checkbox"/> H2 O = 4 holes/2 each side, open	<input type="checkbox"/>	<input type="checkbox"/>	<input type="checkbox"/>	<input type="checkbox"/>	<input type="checkbox"/>	<input type="checkbox"/>	<input type="checkbox"/>	<input type="checkbox"/>	<input type="checkbox"/>	<input type="checkbox"/>	<input type="checkbox"/>	<input type="checkbox"/>

FANCY STONES & SETTINGS

4600

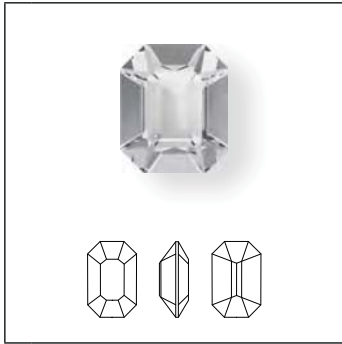

Size	6x4 mm	8x6 mm	10x8 mm	12x10 mm
------	--------	--------	---------	----------

Crystal	Crystal F (001)		
Colors	Plain Colors		
Plain Colors	Jet (280)	Montana F (207)	Rose F (209)
Crystal Effects	Transparent Effects		
Transparent Effects	Crystal Golden Shadow F (001 GSHA)	Crystal Silver Shade F (001 SSHA)	

4600/S

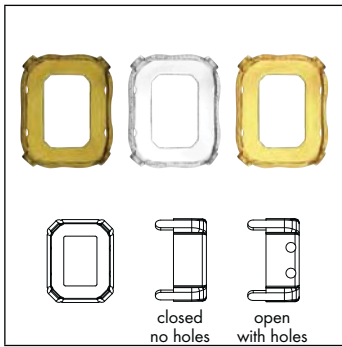

Size & color of plating	6x4 mm Unplated	8x6 mm Unplated	10x8 mm Unplated	12x10 mm Unplated	6x4 mm Rhodium	8x6 mm Rhodium	10x8 mm Rhodium	12x10 mm Rhodium	6x4 mm Gold	8x6 mm Gold	10x8 mm Gold	12x10 mm Gold
-------------------------	-----------------	-----------------	------------------	-------------------	----------------	----------------	-----------------	------------------	-------------	-------------	--------------	---------------

Ring/Hole, Back Configuration	00 C = No ring/hole, closed	H2 O = 4 holes/2 each side, open
-------------------------------	-----------------------------	----------------------------------

FANCY STONES & SETTINGS

4610



Size	14x10 mm	18x13 mm	20x15 mm
------	----------	----------	----------

Crystal

Crystal F (001)	<input type="checkbox"/>	<input type="checkbox"/>	<input type="checkbox"/>
-----------------	--------------------------	--------------------------	--------------------------

Colors

Plain Colors

Amethyst F (204)	<input type="checkbox"/>	<input type="checkbox"/>	<input type="checkbox"/>
Aquamarine F (202)	<input type="checkbox"/>	<input type="checkbox"/>	<input type="checkbox"/>
Black Diamond F (215)	<input type="checkbox"/>	<input type="checkbox"/>	<input type="checkbox"/>
Emerald F (205)	<input type="checkbox"/>	<input type="checkbox"/>	<input type="checkbox"/>
Jet (280)	<input type="checkbox"/>	<input type="checkbox"/>	<input type="checkbox"/>
Light Colorado Topaz F (246)	<input type="checkbox"/>	<input type="checkbox"/>	<input type="checkbox"/>
Montana F (207)	<input type="checkbox"/>	<input type="checkbox"/>	<input type="checkbox"/>
Peridot F (214)	<input type="checkbox"/>	<input type="checkbox"/>	<input type="checkbox"/>
Siam F (208)	<input type="checkbox"/>	<input type="checkbox"/>	<input type="checkbox"/>
Tanzanite F (539)	<input type="checkbox"/>	<input type="checkbox"/>	<input type="checkbox"/>

Crystal Effects

Transparent Effects

Crystal Golden Shadow F (001 GSHA)	<input type="checkbox"/>	<input type="checkbox"/>	<input type="checkbox"/>
Crystal Silver Shade F (001 SSHA)	<input type="checkbox"/>	<input type="checkbox"/>	<input type="checkbox"/>

4610/S

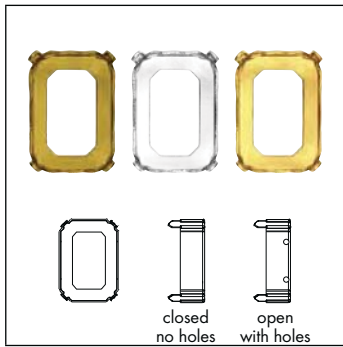

Size & color of plating	14x10 mm Unplated	18x13 mm Unplated	20x15 mm Unplated	14x10 mm Rhodium	18x13 mm Rhodium	20x15 mm Rhodium	14x10 mm Gold	18x13 mm Gold	20x15 mm Gold
-------------------------	-------------------	-------------------	-------------------	------------------	------------------	------------------	---------------	---------------	---------------

Ring/Hole, Back Configuration

00 C = No ring/hole, closed	<input type="checkbox"/>	<input type="checkbox"/>	<input type="checkbox"/>	<input type="checkbox"/>	<input type="checkbox"/>	<input type="checkbox"/>	<input type="checkbox"/>	<input type="checkbox"/>	<input type="checkbox"/>
H2 O = 4 holes/2 each side, open	<input type="checkbox"/>	<input type="checkbox"/>	<input type="checkbox"/>	<input type="checkbox"/>	<input type="checkbox"/>	<input type="checkbox"/>	<input type="checkbox"/>	<input type="checkbox"/>	<input type="checkbox"/>

FANCY STONES & SETTINGS

4627

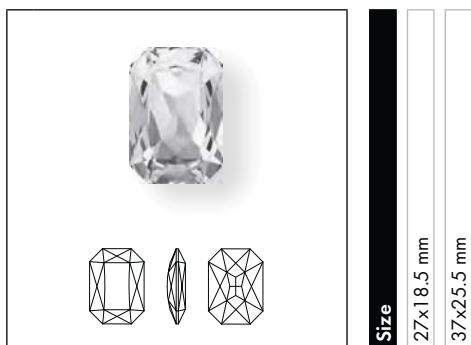

- Crystal**
- Crystal F (001)
- Colors**
- Plain Colors**
- Amethyst F (204)
- Aquamarine F (202)
- Black Diamond F (215)
- Emerald F (205)
- Jet (280)
- Light Colorado Topaz F (246)
- Montana F (207)
- Tanzanite F (539)
- Crystal Effects**
- Transparent Effects**
- Crystal AB F (001 AB)
- Crystal Golden Shadow F (001 GSHA)
- Crystal Silver Shade F (001 SSHA)
- Crystal Vitrail Medium (001 VM)
- Color Effect**
- Metallic Effects**
- Jet Hematite (280 HEM)

4627/S

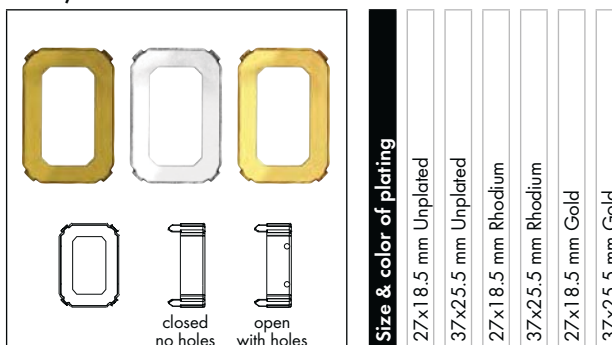

- Ring/Hole, Back Configuration**
- 00 C = No ring/hole, closed
- H2 O = 4 holes/2 each side, open

4675



- Crystal**
- Crystal F (001)
- Crystal Effects**
- Transparent Effects**
- Crystal Golden Shadow F (001 GSHA)
- Crystal Silver Shade F (001 SSHA)

4675/S

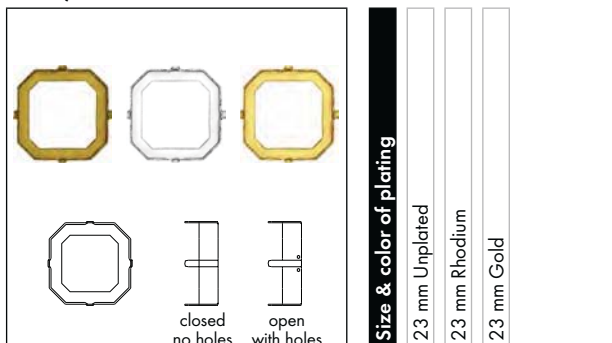

- Ring/Hole, Back Configuration**
- 00 C = No ring/hole, closed
- H2 O = 4 holes/2 each side, open

FANCY STONES & SETTINGS

4678 Solaris Fancy Stone

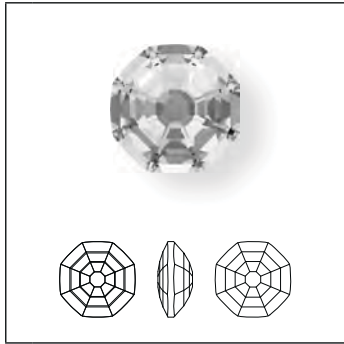

Size	8 mm	14 mm	23 mm
------	------	-------	-------

Crystal

Crystal F (001)	■	■	■
-----------------	---	---	---

Crystal Effects

Transparent Effects

Crystal Antique Pink F (001 ANTP)	■	■	■
Crystal Golden Shadow F (001 GSHA)	■	■	■
Crystal Silver Night (001 SINI)	■	■	■

Metallic Effects

Crystal Iridescent Green F (001 IRIG)	■	■	■
---------------------------------------	---	---	---

4678/S

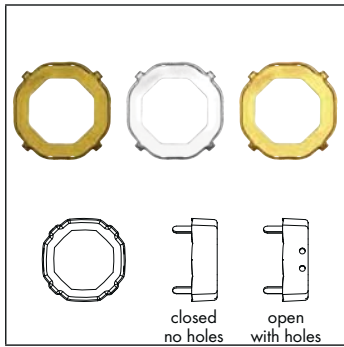

Size & color of plating	8 mm Unplated	14 mm Unplated	23 mm Unplated	8 mm Rhodium	14 mm Rhodium	23 mm Rhodium	8 mm Gold	14 mm Gold	23 mm Gold
-------------------------	---------------	----------------	----------------	--------------	---------------	---------------	-----------	------------	------------

Ring/Hole, Back Configuration

00 C = No ring/hole, closed	■	■	■	■	■	■	■	■	■
H2 O = 4 holes/2 each side, open	■	■	■	■	■	■	■	■	■

FANCY STONES & SETTINGS

DESIGNER EDITION

ATELIER MUNSTEINER FOR SWAROVSKI

Vision Hexagon Fancy Stone

The new Vision Designer Edition marks the first ever collaboration between Swarovski and Atelier Munsteiner, a German design house renowned for its multi-award-winning gemstone cuts, fine jewelry, and sculptures. The family-owned company's third-generation master craftsmen have drawn upon many years of experience to develop this stunning crystal innovation exclusively for Swarovski.

The Vision Designer Edition combines the uncomplicated appeal of simple cuts with the playfulness of mirrored reflections. These ingeniously crafted design elements

bring to mind frozen water, with mysteriously encapsulated air bubbles forming a perfectly geometrical, flower-like shape within the crystal. It is available in three of the most popular shapes for Jewelry and Accessories – the round, square, and hexagon – offering endless design possibilities and making it ideal for use in Glamorous and Progressive creations.

It's the subtlety in the simplicity that makes this Designer Edition truly "VISIONARY."

4681 Vision Hexagon Fancy Stone

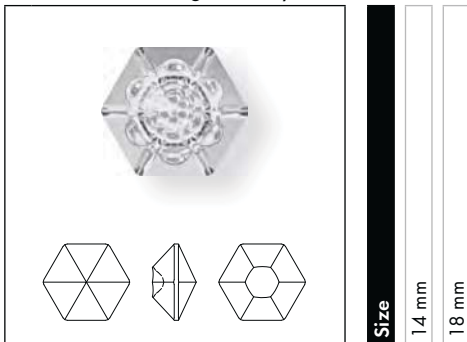

Size

14 mm

18 mm

Crystal

Crystal F (001)

Colors

Plain Colors

Aquamarine F (202)

Erinite F (360)

Light Colorado Topaz F (246)

Light Peach F (362)

Light Siam F (227)

Rose F (209)

Smoky Mauve F (265)

Tanzanite F (539)

Crystal Effects

Transparent Effects

Crystal Antique Pink F (001 ANTP)

Crystal Astral Pink F (001 API)

Crystal Blue Shade F (001 BLSH)

Crystal Golden Shadow F (001 GSHA)

Crystal Luminous Green F (001 LUMG)

Crystal Silver Night F (001 SINI)

4681/S

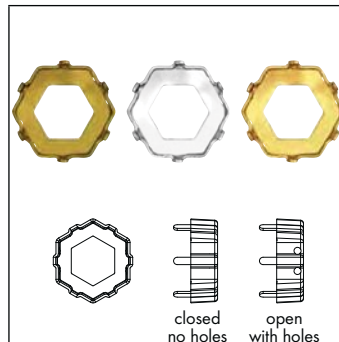

Size & color of plating

14 mm Unplated

18 mm Unplated

14 mm Rhodium

18 mm Rhodium

14 mm Gold

18 mm Gold

Ring/Hole, Back Configuration

00 C = No ring/hole, closed

H2 O = 4 holes/2 each side, open

THE VISION DESIGNER EDITION FAMILY



1681
12, 16 mm

chapter 01 Round Stones
p. 84



4681
14, 18 mm

chapter 02 Fancy Stones & Settings
p. 140



1681/S
12, 16 mm

chapter 01 Round Stones
p. 84



4681/S
14, 18 mm

chapter 02 Fancy Stones & Settings
p. 140



4481
12, 16 mm

chapter 02 Fancy Stones & Settings
p. 125



4481/S
12, 16 mm

chapter 02 Fancy Stones & Settings
p. 125

DESIGNER EDITIONS - DISTINCT PACKAGING

This Designer Edition will be labelled with the "Designer Edition" imprint directly on the packaging.

FANCY STONES & SETTINGS

4706 Trilliant Fancy Stone

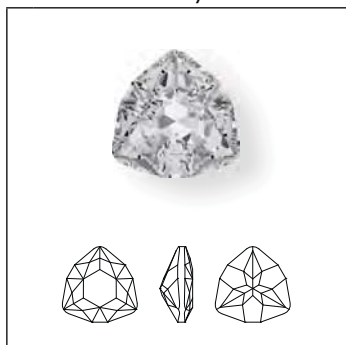

Size	7 mm	12 mm	17 mm	24 mm
------	------	-------	-------	-------

Crystal

Crystal F (001)

Colors

Plain Colors

Amethyst F (204)

Aquamarine F (202)

Light Colorado Topaz F (246)

Rose F (209)

Tanzanite F (539)

Vintage Rose F (319)

Crystal Effects

Transparent Effects

Crystal AB F (001 AB)

Crystal Blue Shade F (001 BLSH)

Crystal Golden Shadow F (001 GSHA)

Crystal Luminous Green F (001 LUMG)

Crystal Silver Night (001 SINI)

Crystal Silver Shade F (001 SSHA)

Crystal Patina Effects

Crystal Black Patina F (001 BLAPA)

Crystal Gold Patina F (001 GOLPA)

Crystal Rose Patina F (001 ROSPA)

Crystal Silver Patina F (001 SILPA)

Crystal White Patina F (001 WHIPA)

4706/S

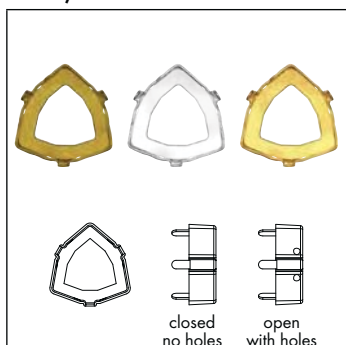

Size & color of plating	7 mm Unplated	12 mm Unplated	17 mm Unplated	24 mm Unplated	7 mm Rhodium	12 mm Rhodium	17 mm Rhodium	24 mm Rhodium	7 mm Gold	12 mm Gold	17 mm Gold	24 mm Gold
-------------------------	---------------	----------------	----------------	----------------	--------------	---------------	---------------	---------------	-----------	------------	------------	------------

Ring/Hole, Back Configuration

00 C = No ring/hole, closed

H2 O = 6 holes/2 each side, open

FANCY STONES & SETTINGS

4717 Delta Fancy Stone

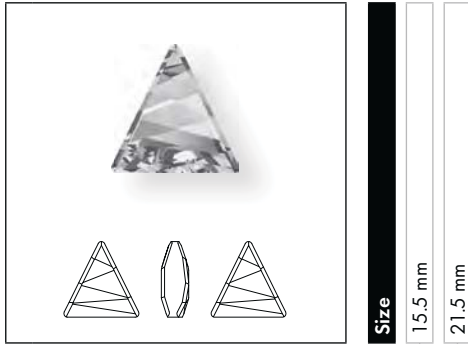

Size
15.5 mm
21.5 mm

Crystal

Crystal F (001)

Colors

Plain Colors

Aquamarine F (202)

Black Diamond F (215)

Denim Blue F (266)

Montana F (207)

Crystal Effects

Transparent Effects

Crystal Antique Pink F (001 ANTP)

Crystal Astral Pink F (001 API)

Crystal Golden Shadow F (001 GSHA)

Crystal Silver Shade F (001 SSHA)

4717/S

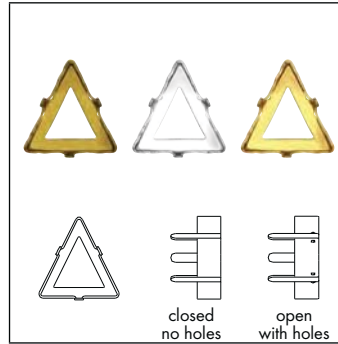

Size & color of plating

15.5 mm Unplated
21.5 mm Unplated
15.5 mm Rhodium
21.5 mm Rhodium
15.5 mm Gold
21.5 mm Gold

Ring/Hole, Back Configuration

00 C = No ring/hole, closed

H2 O = 4 holes/2 each side, open

FANCY STONES & SETTINGS

4722



Size

- 4 mm
- 6 mm
- 8 mm
- 10 mm

Crystal

Crystal F (001)

4722/S

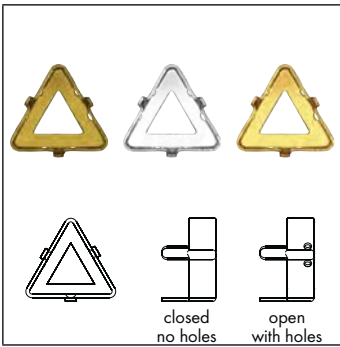

Size & color of plating

- 4 mm Unplated
- 6 mm Unplated
- 8 mm Unplated
- 10 mm Unplated
- 4 mm Rhodium
- 6 mm Rhodium
- 8 mm Rhodium
- 10 mm Rhodium
- 4 mm Gold
- 6 mm Gold
- 8 mm Gold
- 10 mm Gold

Ring/Hole, Back Configuration

00 C = No ring/hole, closed

H2 O = 6 holes/2 each side, open

H2 O = 3 holes/1 each side, open

FANCY STONES & SETTINGS

4731 Kite Fancy Stone

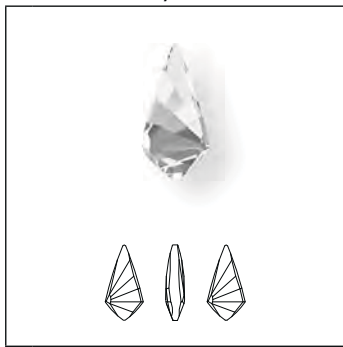

Crystal

Crystal F (001)

Colors

Plain Colors

Aquamarine F (202)

Erinite F (360)

Tanzanite F (539)

Crystal Effects

Transparent Effects

Crystal AB F (001 AB)

Crystal Antique Pink F (001 ANTP)

Crystal Blue Shade F (001 BLSH)

Crystal Golden Shadow F (001 GSHA)

Crystal Luminous Green F (001 LUMG)

Crystal Silver Night (001 SINI)

Crystal Silver Shade F (001 SSHA)

Size	10x5 mm	14x7 mm	18x9 mm	23x11.5 mm
Crystal F (001)	<input type="checkbox"/>	<input type="checkbox"/>	<input type="checkbox"/>	<input type="checkbox"/>
Aquamarine F (202)	<input type="checkbox"/>	<input type="checkbox"/>	<input type="checkbox"/>	<input type="checkbox"/>
Erinite F (360)	<input type="checkbox"/>	<input type="checkbox"/>	<input type="checkbox"/>	<input type="checkbox"/>
Tanzanite F (539)	<input type="checkbox"/>	<input type="checkbox"/>	<input type="checkbox"/>	<input type="checkbox"/>
Crystal AB F (001 AB)	<input type="checkbox"/>	<input type="checkbox"/>	<input type="checkbox"/>	<input type="checkbox"/>
Crystal Antique Pink F (001 ANTP)	<input type="checkbox"/>	<input type="checkbox"/>	<input type="checkbox"/>	<input type="checkbox"/>
Crystal Blue Shade F (001 BLSH)	<input type="checkbox"/>	<input type="checkbox"/>	<input type="checkbox"/>	<input type="checkbox"/>
Crystal Golden Shadow F (001 GSHA)	<input type="checkbox"/>	<input type="checkbox"/>	<input type="checkbox"/>	<input type="checkbox"/>
Crystal Luminous Green F (001 LUMG)	<input type="checkbox"/>	<input type="checkbox"/>	<input type="checkbox"/>	<input type="checkbox"/>
Crystal Silver Night (001 SINI)	<input type="checkbox"/>	<input type="checkbox"/>	<input type="checkbox"/>	<input type="checkbox"/>
Crystal Silver Shade F (001 SSHA)	<input type="checkbox"/>	<input type="checkbox"/>	<input type="checkbox"/>	<input type="checkbox"/>

4731/S



Ring/Hole, Back Configuration

00 C = No ring/hole, closed

H2 O = 4 holes/2 each side, open

Size & color of plating	10x5 mm Unplated	14x7 mm Unplated	18x9 mm Unplated	23x11.5 mm Unplated	10x5 mm Rhodium	14x7 mm Rhodium	18x9 mm Rhodium	23x11.5 mm Rhodium	10x5 mm Gold	14x7 mm Gold	18x9 mm Gold	23x11.5 mm Gold
00 C = No ring/hole, closed	<input type="checkbox"/>	<input type="checkbox"/>	<input type="checkbox"/>	<input type="checkbox"/>	<input type="checkbox"/>	<input type="checkbox"/>	<input type="checkbox"/>	<input type="checkbox"/>	<input type="checkbox"/>	<input type="checkbox"/>	<input type="checkbox"/>	<input type="checkbox"/>
H2 O = 4 holes/2 each side, open	<input type="checkbox"/>	<input type="checkbox"/>	<input type="checkbox"/>	<input type="checkbox"/>	<input type="checkbox"/>	<input type="checkbox"/>	<input type="checkbox"/>	<input type="checkbox"/>	<input type="checkbox"/>	<input type="checkbox"/>	<input type="checkbox"/>	<input type="checkbox"/>

FANCY STONES & SETTINGS

4739 Cosmic Fancy Stone

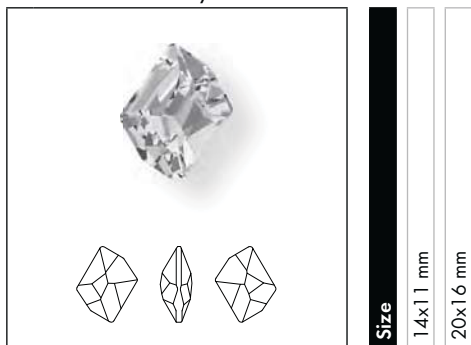

- Crystal**
- Crystal F (001)
- Colors**
- Plain Colors**
- Aquamarine F (202)
- Light Amethyst F (212)
- Rose F (209)
- Crystal Effects**
- Transparent Effects**
- Crystal Golden Shadow F (001 GSHA)
- Crystal Silver Shade F (001 SSJA)

4739/S

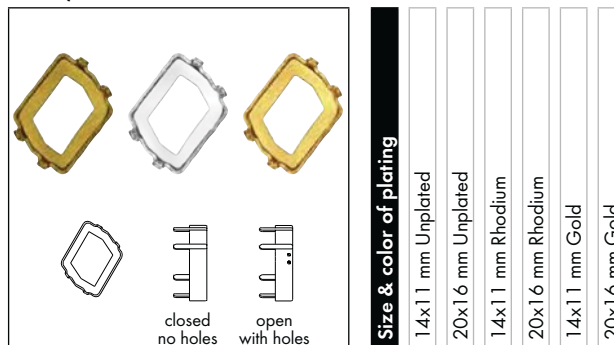

- Ring/Hole, Back Configuration**
- 00 C = No ring/hole, closed
- H2 O = 4 holes/2 each side, open

4744 Rivoli Flower Fancy Stone

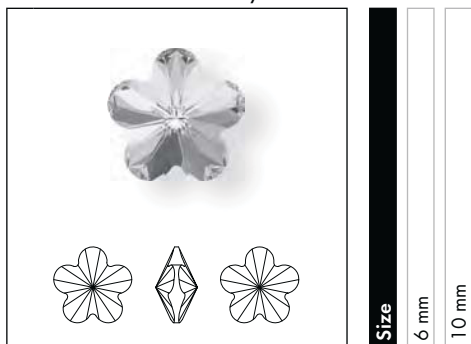

- Crystal**
- Crystal F (001)
- Colors**
- Plain Colors**
- Aquamarine F (202)
- Fuchsia F (502)
- Light Rose F (223)
- Violet F (371)
- Crystal Effects**
- Transparent Effects**
- Crystal AB F (001 AB)

4744/S

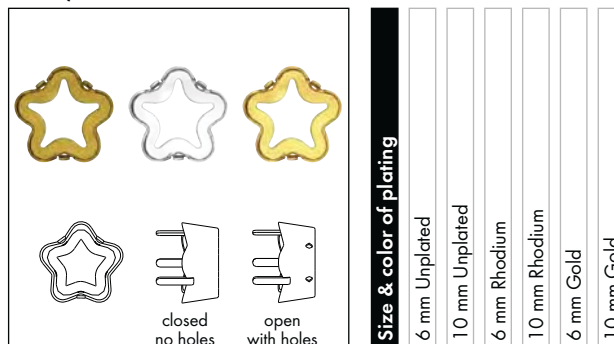

- Ring/Hole, Back Configuration**
- 00 C = No ring/hole, closed
- H2 O = 5 holes/1 each side, open

FANCY STONES & SETTINGS

4745 Rivoli Star Fancy Stone



Size	
5 mm	10 mm
Crystal	
<input type="checkbox"/> Crystal F (001)	
Colors	
Plain Colors	
<input type="checkbox"/> Jet (280)	
Crystal Effects	
Transparent Effects	
<input type="checkbox"/> Crystal AB F (001 AB)	
<input type="checkbox"/> Crystal Bermuda Blue F (001 BBL)	
<input type="checkbox"/> Crystal Golden Shadow F (001 GSHA)	
<input type="checkbox"/> Crystal Silver Shade F (001 SSHA)	
<input type="checkbox"/> Crystal Vitrail Light F (001 VL)	
<input type="checkbox"/> Crystal Vitrail Medium F (001 VM)	
Metallic Effects	
<input type="checkbox"/> Crystal Rose Gold F (001 ROGL)	

4745/S

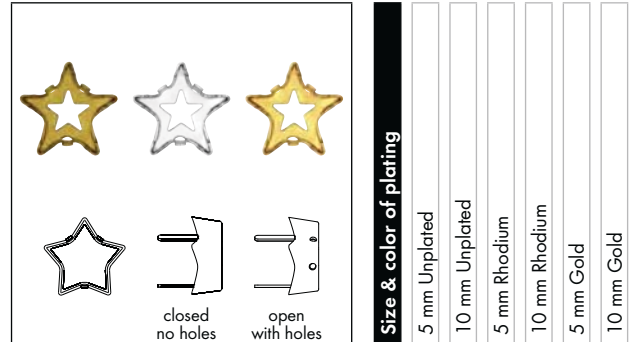

Size & color of plating	
5 mm Unplated	
10 mm Unplated	
5 mm Rhodium	
10 mm Rhodium	
5 mm Gold	
10 mm Gold	
Ring/Hole, Back Configuration	
<input type="checkbox"/> 00 C = No ring/hole, closed	
<input type="checkbox"/> H2 O = 5 holes/1 each side, open	

4748 Rivoli Butterfly Fancy Stone

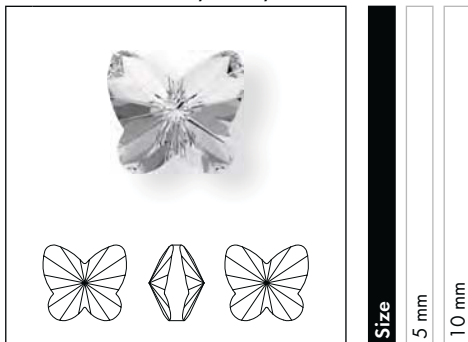

Size	
5 mm	10 mm
Crystal	
<input type="checkbox"/> Crystal F (001)	
Colors	
Plain Colors	
<input type="checkbox"/> Aquamarine F (202)	
<input type="checkbox"/> Light Amethyst F (212)	
<input type="checkbox"/> Light Rose F (223)	
<input type="checkbox"/> Provence Lavender F (283)	
<input type="checkbox"/> Rose Peach F (262)	
Crystal Effects	
Transparent Effects	
<input type="checkbox"/> Crystal Golden Shadow F (001 GSHA)	

4748/S

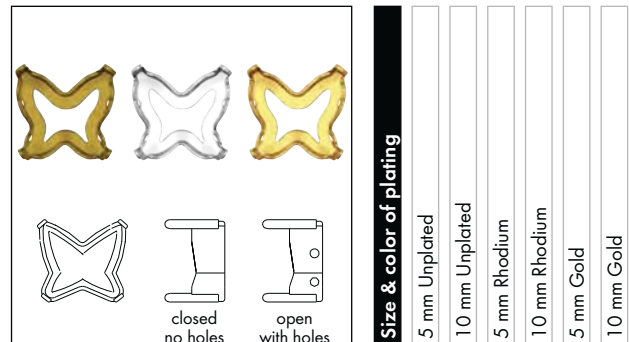

Size & color of plating	
5 mm Unplated	
10 mm Unplated	
5 mm Rhodium	
10 mm Rhodium	
5 mm Gold	
10 mm Gold	
Ring/Hole, Back Configuration	
<input type="checkbox"/> 00 C = No ring/hole, closed	
<input type="checkbox"/> H2 O = 4 holes/2 each side, open	
<input type="checkbox"/> H2 O = 2 holes/1 each side, open	

FANCY STONES & SETTINGS

4753 Edelweiss Fancy Stone



Size	14 mm	18 mm	23 mm
------	-------	-------	-------

Crystal	
Crystal F (001)	<input checked="" type="checkbox"/>
Colors	
Plain Colors	
Amethyst F (204)	<input checked="" type="checkbox"/>
Aquamarine F (202)	<input checked="" type="checkbox"/>
Light Siam F (227)	<input checked="" type="checkbox"/>
Vintage Rose F (319)	<input checked="" type="checkbox"/>
Opal Colors	
White Opal F (234)	<input checked="" type="checkbox"/>
Crystal Effects	
Transparent Effects	
Crystal AB F (001 AB)	<input checked="" type="checkbox"/>
Crystal Blue Shade F (001 BLSH)	<input checked="" type="checkbox"/>
Crystal Golden Shadow F (001 GSHA)	<input checked="" type="checkbox"/>
Crystal Luminous Green F (001 LUMG)	<input checked="" type="checkbox"/>
Crystal Silver Night (001 SINI)	<input checked="" type="checkbox"/>

4753/G Edelweiss Fancy Stone partly frosted



Size	14 mm	18 mm	23 mm
------	-------	-------	-------

Crystal	
Crystal F (001)	<input checked="" type="checkbox"/>
Crystal Effects	
Transparent Effects	
Crystal AB F (001 AB)	<input checked="" type="checkbox"/>
Crystal Blue Shade F (001 BLSH)	<input checked="" type="checkbox"/>
Crystal Golden Shadow F (001 GSHA)	<input checked="" type="checkbox"/>
Crystal Luminous Green F (001 LUMG)	<input checked="" type="checkbox"/>
Crystal Silver Night (001 SINI)	<input checked="" type="checkbox"/>

4753/S¹

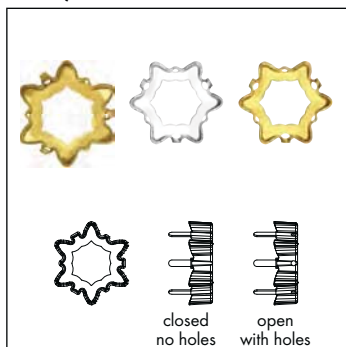

Size & color of plating	14 mm Unplated	18 mm Unplated	23 mm Unplated	14 mm Rhodium	18 mm Rhodium	23 mm Rhodium	14 mm Gold	18 mm Gold	23 mm Gold
-------------------------	----------------	----------------	----------------	---------------	---------------	---------------	------------	------------	------------

Ring/Hole, Back Configuration	
00 C = No ring/hole, closed	<input checked="" type="checkbox"/>
H2 O = 6 holes/1 each side, open	<input checked="" type="checkbox"/>

¹ The Setting 4753/S for article 4753 can also be used for article 4753/G.

FANCY STONES & SETTINGS

4756 Galactic Flat Fancy Stone



Crystal

Crystal F (001)

Colors

Plain Colors

Jet (280)

Crystal Effects

Transparent Effects

Crystal Golden Shadow F (001 GSHA)

Crystal Silver Shade F (001 SSHA)

Color Effects

Metallic Effects

Jet Hematite (280 HEM)

Size

19x11.5 mm

27x16 mm

39x23.5 mm

4756/S

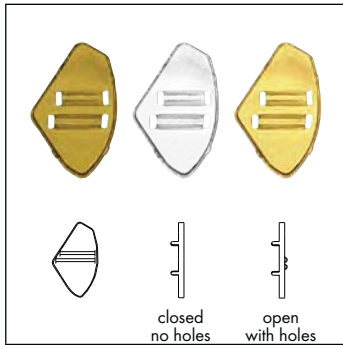

Ring/Hole, Back Configuration

00 C = No ring/hole, closed

H2 O = 2 holes for sewing at the back

Size & color of plating

19x11.5 mm Unplated

27x16 mm Unplated

39x23.5 mm Unplated

19x11.5 mm Rhodium

27x16 mm Rhodium

39x23.5 mm Rhodium

19x11.5 mm Gold

27x16 mm Gold

39x23.5 mm Gold

FANCY STONES & SETTINGS

4757 Galactic Fancy Stone

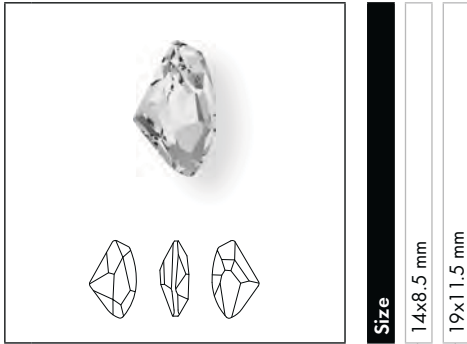

Size

14x8.5 mm

19x11.5 mm

Crystal

Crystal F (001)

Colors

Plain Colors

Aquamarine F (202)

Crystal Effects

Transparent Effects

Crystal Golden Shadow F (001 GSHA)

4757/S

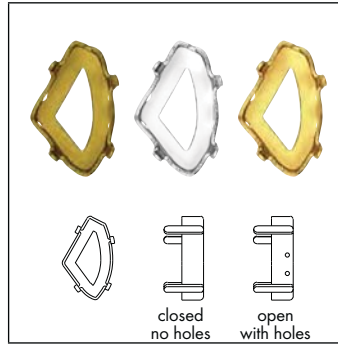

closed no holes open with holes

Ring/Hole, Back Configuration

00 C = No ring/hole, closed

H2 O = 4 holes/2 each side, open

Size & color of plating

14x8.5 mm Unplated

19x11.5 mm Unplated

14x8.5 mm Rhodium

19x11.5 mm Rhodium

14x8.5 mm Gold

19x11.5 mm Gold

FANCY STONES & SETTINGS

4773 Meteor Fancy Stone

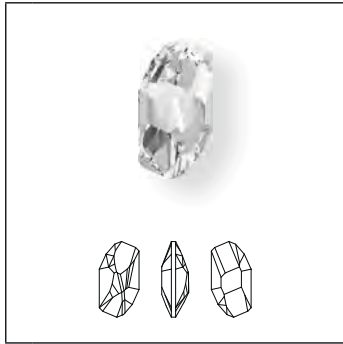

Crystal

Crystal F (001)

Colors

Plain Colors

Black Diamond F (215)

Crystal Effects

Transparent Effects

Crystal Antique Pink F (001 ANTP)

Crystal Blue Shade F (001 BLSH)

Size	14x7.5 mm	18x9.5 mm	28x15 mm
Crystal F (001)	■	■	■
Black Diamond F (215)	■	■	■
Crystal Antique Pink F (001 ANTP)	■	■	■
Crystal Blue Shade F (001 BLSH)	■	■	■

4773/S

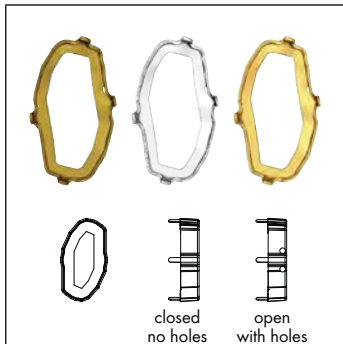

Ring/Hole, Back Configuration

00 C = No ring/hole, closed

H2 O = 4 holes/2 each side, open

Size & color of plating	14x7.5 mm Unplated	18x9.5 mm Unplated	28x15 mm Unplated	14x7.5 mm Rhodium	18x9.5 mm Rhodium	28x15 mm Rhodium	14x7.5 mm Gold	18x9.5 mm Gold	28x15 mm Gold
00 C = No ring/hole, closed	■	■	■	■	■	■	■	■	■
H2 O = 4 holes/2 each side, open	■	■	■	■	■	■	■	■	■

FANCY STONES & SETTINGS

4778 Fatima Hand Fancy Stone



Size

18x13.7 mm

Crystal

Crystal F (001)

Colors

Plain Colors

Light Siam F (227)

Crystal Effects

Transparent Effects

Crystal AB F (001 AB)

Crystal Blue Shade F (001 BLSH)

Crystal Golden Shadow F (001 GSHA)

Crystal Luminous Green F (001 LUMG)

Crystal Silver Night (001 SINI)

Crystal Silver Shade F (001 SSHA)

Metallic Effects

Crystal Rose Gold F (001 ROGL)

4778/S

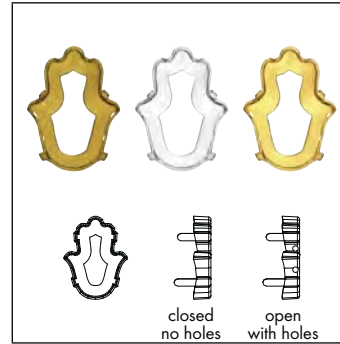

Size & color of plating

18x13.7 mm Unplated

18x13.7 mm Rhodium

18x13.7 mm Gold

Ring/Hole, Back Configuration

00 C = No ring/hole, closed

H2 O = 4 holes/2 each side, open

FANCY STONES & SETTINGS

4779 Buddha Fancy Stone



Size

18x15.6 mm

Crystal

Crystal F (001)

Colors

Plain Colors

Light Siam F (227)

Crystal Effects

Transparent Effects

Crystal AB F (001 AB)

Crystal Blue Shade F (001 BLSH)

Crystal Golden Shadow F (001 GSHA)

Crystal Luminous Green F (001 LUMG)

Crystal Silver Night (001 SINI)

Crystal Silver Shade F (001 SSHA)

Metallic Effects

Crystal Rose Gold F (001 ROGL)

4779/S

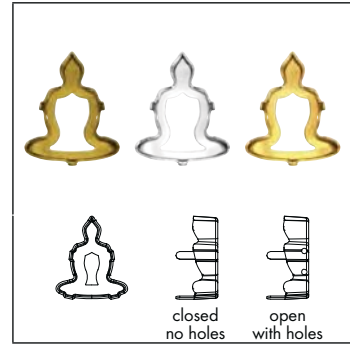

Size & color of plating

18x15.6 mm Unplated

18x15.6 mm Rhodium

18x15.6 mm Gold

Ring/Hole, Back Configuration

00 C = No ring/hole, closed

H2 O = 4 holes/2 each side, open

FANCY STONES & SETTINGS

4784 Greek Cross Fancy Stone



Size
8 mm
14 mm
23 mm

- Crystal**
- Crystal F (001)
- Colors**
- Plain Colors**
- Jet (280)
- Crystal Effects**
- Transparent Effects**
- Crystal AB F (001 AB)
- Crystal Antique Pink F (001 ANTP)
- Crystal Golden Shadow F (001 GSHA)
- Crystal Luminous Green F (001 LUMG)
- Crystal Silver Night (001 SINI)
- Crystal Vitrail Medium (001 VM)
- Metallic Effects**
- Crystal Metallic Sunshine F (001 METSH)
- Crystal Rose Gold F (001 ROGL)

4784/S

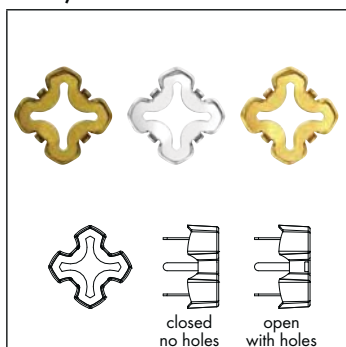

Size & color of plating
8 mm Unplated
14 mm Unplated
23 mm Unplated
8 mm Rhodium
14 mm Rhodium
23 mm Rhodium
8 mm Gold
14 mm Gold
23 mm Gold

- Ring/Hole, Back Configuration**
- 00 C = No ring/hole, closed
- H2 O = 4 holes/1 each side, open

FANCY STONES & SETTINGS

4785 Clover Fancy Stone

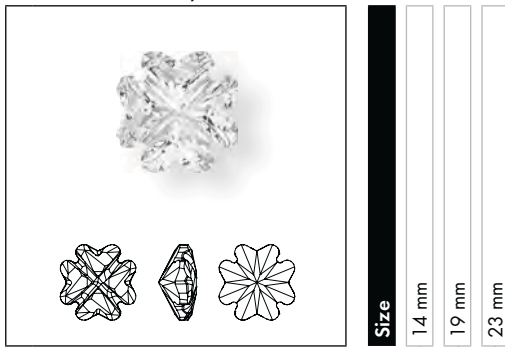

Crystal	14 mm	19 mm	23 mm
Crystal F (001)	■	■	■
Colors			
Plain Colors			
Emerald F (205)	■	■	■
Peridot F (214)	■	■	■
Crystal Effects			
Transparent Effects			
Crystal AB F (001 AB)	■	■	■
Crystal Antique Pink F (001 ANTP)	■	■	■
Crystal Blue Shade F (001 BLSH)	■	■	■
Crystal Golden Shadow F (001 GSHA)	■	■	■
Crystal Luminous Green F (001 LUMG)	■	■	■
Crystal Silver Night (001 SINI)	■	■	■
Metallic Effects			
Crystal Rose Gold F (001 ROGL)	■	■	■

4785/S

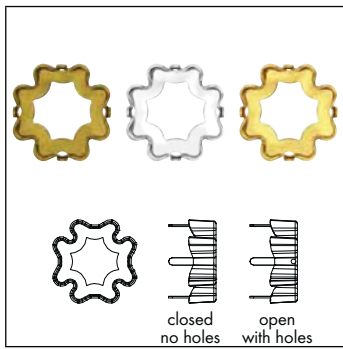

Ring/Hole, Back Configuration	14 mm Unplated	19 mm Unplated	23 mm Unplated	14 mm Rhodium	19 mm Rhodium	23 mm Rhodium	14 mm Gold	19 mm Gold	23 mm Gold
00 C = No ring/hole, closed	■	■	■	■	■	■	■	■	■
H2 O = 4 holes/1 each side, open	■	■	■	■	■	■	■	■	■

FANCY STONES & SETTINGS

4789 Shell Fancy Stone



Size 14 mm

4789 Shell Fancy Stone



Size 23, 29 mm

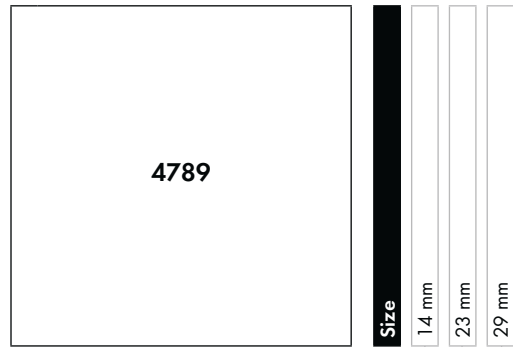

Crystal			
Crystal F (001)	<input type="checkbox"/>	<input type="checkbox"/>	<input type="checkbox"/>
Colors			
Plain Colors			
Aquamarine F (202)	<input type="checkbox"/>	<input type="checkbox"/>	<input type="checkbox"/>
Indicolite F (379)	<input type="checkbox"/>	<input type="checkbox"/>	<input type="checkbox"/>
Crystal Effects			
Transparent Effects			
Crystal Golden Shadow F (001 GSHA)	<input type="checkbox"/>	<input type="checkbox"/>	<input type="checkbox"/>

4789/S

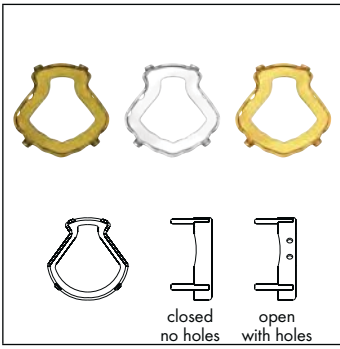

Size & color of plating									
14 mm Unplated	<input type="checkbox"/>	<input type="checkbox"/>	<input type="checkbox"/>	<input type="checkbox"/>	<input type="checkbox"/>	<input type="checkbox"/>	<input type="checkbox"/>	<input type="checkbox"/>	<input type="checkbox"/>
23 mm Unplated	<input type="checkbox"/>	<input type="checkbox"/>	<input type="checkbox"/>	<input type="checkbox"/>	<input type="checkbox"/>	<input type="checkbox"/>	<input type="checkbox"/>	<input type="checkbox"/>	<input type="checkbox"/>
29 mm Unplated	<input type="checkbox"/>	<input type="checkbox"/>	<input type="checkbox"/>	<input type="checkbox"/>	<input type="checkbox"/>	<input type="checkbox"/>	<input type="checkbox"/>	<input type="checkbox"/>	<input type="checkbox"/>
14 mm Rhodium	<input type="checkbox"/>	<input type="checkbox"/>	<input type="checkbox"/>	<input type="checkbox"/>	<input type="checkbox"/>	<input type="checkbox"/>	<input type="checkbox"/>	<input type="checkbox"/>	<input type="checkbox"/>
23 mm Rhodium	<input type="checkbox"/>	<input type="checkbox"/>	<input type="checkbox"/>	<input type="checkbox"/>	<input type="checkbox"/>	<input type="checkbox"/>	<input type="checkbox"/>	<input type="checkbox"/>	<input type="checkbox"/>
29 mm Rhodium	<input type="checkbox"/>	<input type="checkbox"/>	<input type="checkbox"/>	<input type="checkbox"/>	<input type="checkbox"/>	<input type="checkbox"/>	<input type="checkbox"/>	<input type="checkbox"/>	<input type="checkbox"/>
14 mm Gold	<input type="checkbox"/>	<input type="checkbox"/>	<input type="checkbox"/>	<input type="checkbox"/>	<input type="checkbox"/>	<input type="checkbox"/>	<input type="checkbox"/>	<input type="checkbox"/>	<input type="checkbox"/>
23 mm Gold	<input type="checkbox"/>	<input type="checkbox"/>	<input type="checkbox"/>	<input type="checkbox"/>	<input type="checkbox"/>	<input type="checkbox"/>	<input type="checkbox"/>	<input type="checkbox"/>	<input type="checkbox"/>
29 mm Gold	<input type="checkbox"/>	<input type="checkbox"/>	<input type="checkbox"/>	<input type="checkbox"/>	<input type="checkbox"/>	<input type="checkbox"/>	<input type="checkbox"/>	<input type="checkbox"/>	<input type="checkbox"/>

Ring/Hole, Back Configuration	
00 C = No ring/hole, closed	<input type="checkbox"/>
H2 O = 4 holes/2 each side, open	<input type="checkbox"/>

FANCY STONES & SETTINGS

4790 Wing Fancy Stone



Crystal

Crystal F (001)

Colors

Plain Colors

Aquamarine F (202)

Provence Lavender F (283)

Tanzanite F (539)

Crystal Effects

Transparent Effects

Crystal Golden Shadow F (001 GSHA)

Size	18x7.5 mm	23x10 mm	32x13.5 mm
Crystal F (001)	■	■	■
Aquamarine F (202)	■	■	
Provence Lavender F (283)	■	■	■
Tanzanite F (539)	■	■	
Crystal Golden Shadow F (001 GSHA)	■	■	■

4790/S

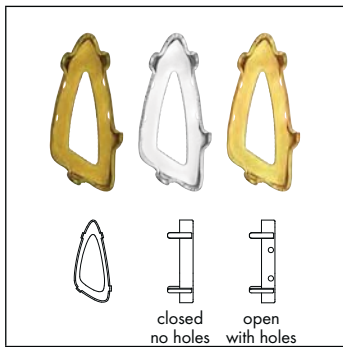

Ring/Hole, Back Configuration

00 C = No ring/hole, closed

H2 O = 4 holes/2 each side, open

Size & color of plating	18x7.5 mm Unplated	23x10 mm Unplated	32x13.5 mm Unplated	18x7.5 mm Rhodium	23x10 mm Rhodium	32x13.5 mm Rhodium	18x7.5 mm Gold	23x10 mm Gold	32x13.5 mm Gold
00 C = No ring/hole, closed	■	■	■	■	■	■	■	■	■
H2 O = 4 holes/2 each side, open	■	■	■	■	■	■	■	■	■

FANCY STONES & SETTINGS

4795 Graphic Fancy Stone



Size

14 mm

19 mm

28 mm

Crystal

Crystal F (001)

Colors

Plain Colors

Amethyst F (204)

Denim Blue F (266)

Crystal Effects

Transparent Effects

Crystal Antique Pink F (001 ANTP)

Crystal Golden Shadow F (001 GSHA)

4795/S

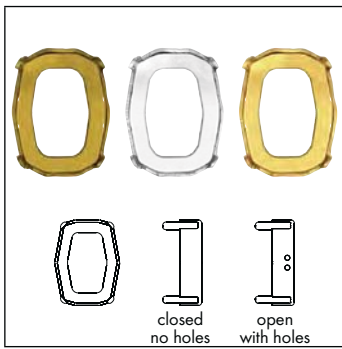

Size & color of plating

14 mm Unplated

19 mm Unplated

28 mm Unplated

14 mm Rhodium

19 mm Rhodium

28 mm Rhodium

14 mm Gold

19 mm Gold

28 mm Gold

Ring/Hole, Back Configuration

00 C = No ring/hole, closed

H2 O = 4 holes/2 each side, open

FANCY STONES & SETTINGS

4809 Sweet Heart Fancy Stone



Size	13x12 mm	17x15.5 mm	27x25 mm
------	----------	------------	----------

Crystal

Crystal F (001)	<input type="checkbox"/>	<input type="checkbox"/>	<input type="checkbox"/>
-----------------	--------------------------	--------------------------	--------------------------

Colors

Plain Colors

Amethyst F (204)	<input type="checkbox"/>	<input type="checkbox"/>	<input type="checkbox"/>
Erinte F (360)	<input type="checkbox"/>	<input type="checkbox"/>	<input type="checkbox"/>
Rose F (209)	<input type="checkbox"/>	<input type="checkbox"/>	<input type="checkbox"/>
Violet F (371)	<input type="checkbox"/>	<input type="checkbox"/>	<input type="checkbox"/>

Crystal Effects

Transparent Effects

Crystal AB F (001 AB)	<input type="checkbox"/>	<input type="checkbox"/>	<input type="checkbox"/>
Crystal Antique Pink F (001 ANTP)	<input type="checkbox"/>	<input type="checkbox"/>	<input type="checkbox"/>
Crystal Blue Shade F (001 BLSH)	<input type="checkbox"/>	<input type="checkbox"/>	<input type="checkbox"/>
Crystal Golden Shadow F (001 GSHA)	<input type="checkbox"/>	<input type="checkbox"/>	<input type="checkbox"/>
Crystal Silver Night (001 SINI)	<input type="checkbox"/>	<input type="checkbox"/>	<input type="checkbox"/>
Crystal Silver Shade F (001 SSHA)	<input type="checkbox"/>	<input type="checkbox"/>	<input type="checkbox"/>

4809/S

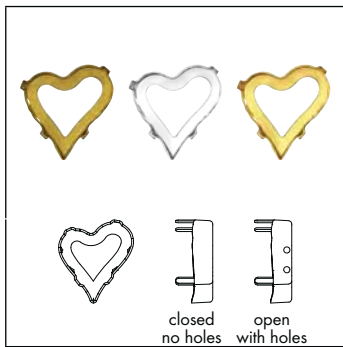

Size & color of plating	13x12 mm Unplated	17x15.5 mm Unplated	27x25 mm Unplated	13x12 mm Rhodium	17x15.5 mm Rhodium	27x25 mm Rhodium	13x12 mm Gold	17x15.5 mm Gold	27x25 mm Gold
-------------------------	-------------------	---------------------	-------------------	------------------	--------------------	------------------	---------------	-----------------	---------------

Ring/Hole, Back Configuration

00 C = No ring/hole, closed	<input type="checkbox"/>	<input type="checkbox"/>	<input type="checkbox"/>	<input type="checkbox"/>	<input type="checkbox"/>	<input type="checkbox"/>	<input type="checkbox"/>	<input type="checkbox"/>	<input type="checkbox"/>
H2 O = 4 holes/2 each side, open	<input type="checkbox"/>	<input type="checkbox"/>	<input type="checkbox"/>	<input type="checkbox"/>	<input type="checkbox"/>	<input type="checkbox"/>	<input type="checkbox"/>	<input type="checkbox"/>	<input type="checkbox"/>

FANCY STONES & SETTINGS

4810 Sweet Heart Fancy Stone



Size

13x12 mm

Crystal

Crystal F (001)

Colors

Plain Colors

Amethyst F (204)

Erinite F (360)

Rose F (209)

Violet F (371)

Crystal Effects

Transparent Effects

Crystal AB F (001 AB)

Crystal Antique Pink F (001 ANTP)

Crystal Blue Shade F (001 BLSH)

Crystal Golden Shadow F (001 GSHA)

Crystal Silver Night (001 SINI)

Crystal Silver Shade F (001 SSHA)

4827



Size

28 mm

Crystal

Crystal F (001)

Colors

Plain Colors

Light Amethyst F (212)

Crystal Effects

Transparent Effects

Crystal AB F (001 AB)

Crystal Bermuda Blue (001 BBL)

Crystal Golden Shadow F (001 GSHA)

4810/S

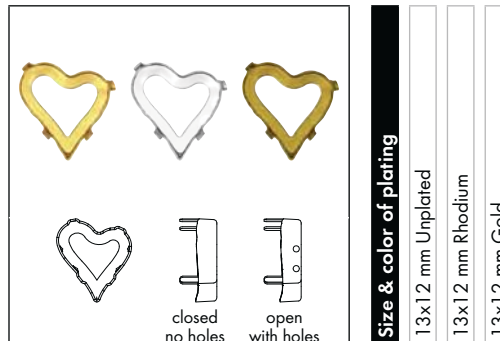

Size & color of plating

13x12 mm Unplated

13x12 mm Rhodium

13x12 mm Gold

Ring/Hole, Back Configuration

00 C = No ring/hole, closed

H2 O = 4 holes/2 each side, open

4827/S

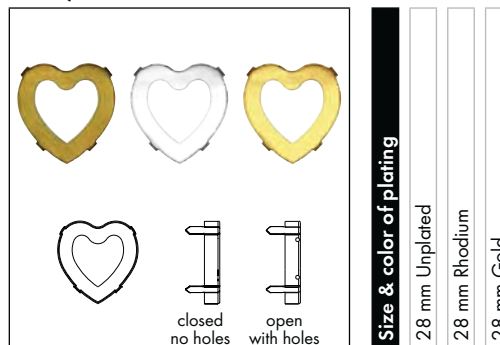

Size & color of plating

28 mm Unplated

28 mm Rhodium

28 mm Gold

Ring/Hole, Back Configuration

00 C = No ring/hole, closed

H2 O = 4 holes/2 each side, open

FANCY STONES & SETTINGS

4831 Antique Heart Fancy Stone



Crystal

Crystal F (001)

Colors

Plain Colors

Light Amethyst F (212)

Light Rose F (223)

Siam F (208)

Size	5.5x5 mm	8.8x8 mm	11x10 mm
Crystal F (001)	■	■	■
Light Amethyst F (212)	■	■	■
Light Rose F (223)	■	■	■
Siam F (208)	■	■	■

4831/S

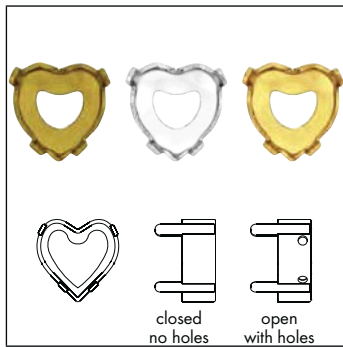

Ring/Hole, Back Configuration

00 C = No ring/hole, closed

H2 O = 4 holes/2 each side, open

H2 O = 2 holes/1 each side, open

Size & color of plating	5.5x5 mm Unplated	8.8x8 mm Unplated	11x10 mm Unplated	5.5x5 mm Rhodium	8.8x8 mm Rhodium	11x10 mm Rhodium	5.5x5 mm Gold	8.8x8 mm Gold	11x10 mm Gold
00 C = No ring/hole, closed	■	■	■	■	■	■	■	■	■
H2 O = 4 holes/2 each side, open	■	■	■	■	■	■	■	■	■
H2 O = 2 holes/1 each side, open	■	■	■	■	■	■	■	■	■

FANCY STONES & SETTINGS

4841

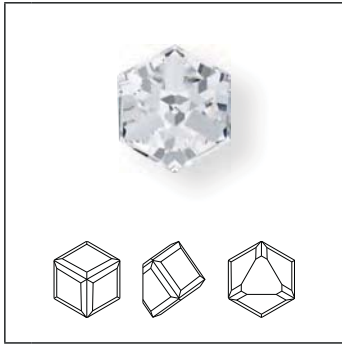

Size	4 mm	6 mm	8 mm
------	------	------	------

Crystal

Crystal CAL VZ (001 CAL VZ)

Colors

Plain Colors

Aquamarine CAL VZ (202 CAL VZ)

Light Rose CAL VZ (223 CAL VZ)

Light Siam CAL VZ (227 CAL VZ)

Violet CAL VZ (371 CAL VZ)

Crystal Effects

Transparent Effects

Crystal AB CAL VZ SI (001 AB CAL VZ SI)

Crystal Bermuda Blue Z (001 BBL Z)

Crystal Heliotrope Z (001 HEL Z)

Crystal Vitrail Light Z (001 VL Z)

Crystal Vitrail Medium Z (001 VM Z)

Crystal Golden Shadow CAL VZ SI (001 GSHA CAL VZ SI)

4869

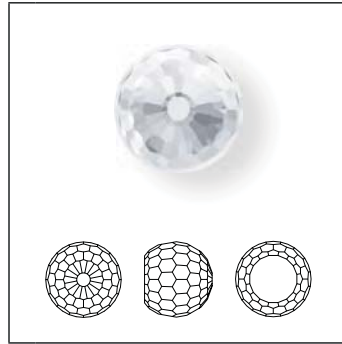

Size	4 mm	6 mm	8 mm
------	------	------	------

Crystal

Crystal CAL VZ (001 CAL VZ)

Colors

Plain Colors

Aquamarine CAL VZ (202 CAL VZ)

Light Rose CAL VZ (223 CAL VZ)

Violet CAL VZ (371 CAL VZ)

Crystal Effects

Transparent Effects

Crystal AB CAL VZ SI (001 AB CAL VZ SI)

Crystal Vitrail Medium Z (001 VM Z)

4876 Female Symbol Fancy Stone

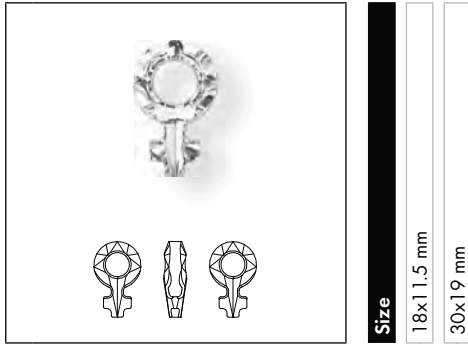

Size
18x11.5 mm
30x19 mm

Crystal

- Crystal (001)
- Crystal F (001)

Crystal Effects

Transparent Effects

- Crystal AB (001 AB)
- Crystal AB F (001 AB)
- Crystal Antique Pink (001 ANTP)
- Crystal Antique Pink F (001 ANTP)
- Crystal Bermuda Blue F (001 BBL)
- Crystal Bermuda Blue P (001 BBL)¹
- Crystal Golden Shadow (001 GSHA)
- Crystal Golden Shadow F (001 GSHA)
- Crystal Silver Night (001 SINI)

4876/S

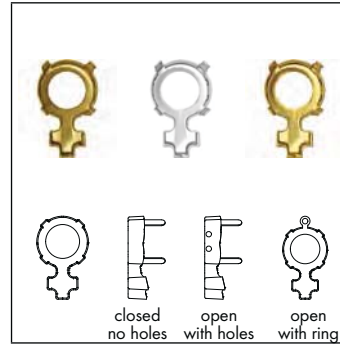

Size & color of plating

- 18x11.5 mm Unplated
- 30x19 mm Unplated
- 18x11.5 mm Rhodium
- 30x19 mm Rhodium
- 18x11.5 mm Gold
- 30x19 mm Gold

Ring/Hole, Back Configuration

- 00 C** = No ring/hole, closed
- H2 O** = 4 holes/2 each side, open
- 1T O** = 1 Ring/Top, open

4878 Male Symbol Fancy Stone



Size
18x11.5 mm
30x19 mm

Crystal

- Crystal (001)
- Crystal F (001)

Crystal Effects

Transparent Effects

- Crystal AB (001 AB)
- Crystal AB F (001 AB)
- Crystal Antique Pink (001 ANTP)
- Crystal Antique Pink F (001 ANTP)
- Crystal Bermuda Blue F (001 BBL)
- Crystal Bermuda Blue P (001 BBL)¹
- Crystal Golden Shadow (001 GSHA)
- Crystal Golden Shadow F (001 GSHA)
- Crystal Silver Night (001 SINI)

4878/S

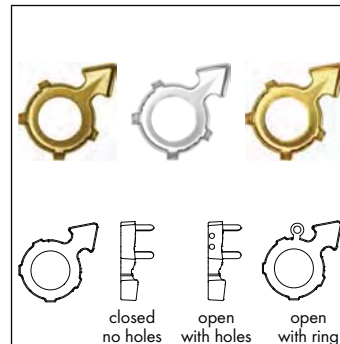

Size & color of plating

- 18x11.5 mm Unplated
- 30x19 mm Unplated
- 18x11.5 mm Rhodium
- 30x19 mm Rhodium
- 18x11.5 mm Gold
- 30x19 mm Gold

Ring/Hole, Back Configuration

- 00 C** = No ring/hole, closed
- H2 O** = 4 holes/2 each side, open
- 1T O** = 1 Ring/Top, open

¹ For details about the "protective layer" please refer to the chapter 'Basic Information'.

FANCY STONES & SETTINGS

4884 XILLION Heart Fancy Stone



Crystal

Crystal F (001)

Colors

Plain Colors

Amethyst F (204)

Aquamarine F (202)

Light Amethyst F (212)

Light Rose F (223)

Light Siam F (227)

Montana F (207)

Peridot F (214)

Rose F (209)

Crystal Effects

Transparent Effects

Crystal Golden Shadow F (001 GSHA)

Size	5.5x5 mm	6.6x6 mm	8.8x8 mm	11x10 mm	15.4x14 mm
Crystal F (001)	■	■	■	■	■
Amethyst F (204)	■	■	■	■	■
Aquamarine F (202)	■	■	■	■	■
Light Amethyst F (212)	■	■	■	■	■
Light Rose F (223)	■	■	■	■	■
Light Siam F (227)	■	■	■	■	■
Montana F (207)	■	■	■	■	■
Peridot F (214)	■	■	■	■	■
Rose F (209)	■	■	■	■	■
Crystal Golden Shadow F (001 GSHA)	■	■	■	■	■

4884/S

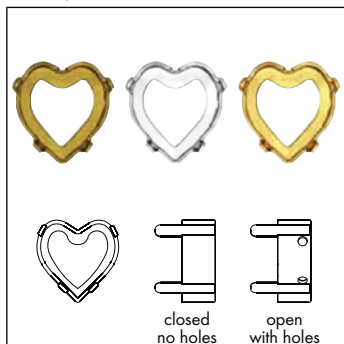

Ring/Hole, Back Configuration

00 C = No ring/hole, closed

H2 O = 4 holes/2 each side, open

H2 O = 2 holes/1 each side, open

Size & color of plating	5.5x5 mm Unplated	6.6x6 mm Unplated	8.8x8 mm Unplated	11x10 mm Unplated	15.4x14 mm Unplated	5.5x5 mm Rhodium	6.6x6 mm Rhodium	8.8x8 mm Rhodium	11x10 mm Rhodium	15.4x14 mm Rhodium	5.5x5 mm Gold	6.6x6 mm Gold	8.8x8 mm Gold	11x10 mm Gold	15.4x14 mm Gold
00 C = No ring/hole, closed	■	■	■	■	■										
H2 O = 4 holes/2 each side, open			■	■	■			■	■	■			■	■	■
H2 O = 2 holes/1 each side, open	■	■				■	■				■	■			

KAPUTT DESIGNED BY JEAN PAUL GAULTIER

Design Story: While the whole world strives for perfection, Swarovski discovers the beauty of imperfection, guided and inspired by none other than design legend Jean Paul Gaultier. Together with Swarovski's own trend, design and product management experts, Gaultier developed the spectacular Kaputt Collection exclusively for Swarovski. Like its name, the German word for "broken," already suggests, the collection presents a technological innovation that deliberately breaks with convention. It celebrates the appeal of being different and unpredictable, which, according to the designer, is much more exciting than the precise and perfect.

Description: Broken and raw, but elegant at the same time, the Kaputt design captivates with distinctively irregular, partly unpolished, or frosted surfaces that give it an all natural, almost meteoritic appearance. It comes in rich, shimmering metallic colors as well as classics, such as Crystal and GSHA, and boasts the famous Jean Paul Gaultier logo as a laser engraving.

Look: In a world of flawless, artificial beauty, Kaputt mirrors the attractiveness of irregular, natural surfaces for a down-to-earth look that is both rock and chic.

CRYSTAL SCARABAEUS GREEN
DESIGNED BY JEAN PAUL GAULTIER

Design Story: Expressing his desire for an exclusive effect that would match his Kaputt Collection, haute couture icon Jean Paul Gaultier developed Crystal Scarabaeus Green together with a team of experts from Swarovski. For his effect he wanted this precise scintillating shade of green, combined with the mythological shimmer of the Egyptian scarab.

Description: Aptly named, Crystal Scarabaeus Green evokes the magic glow of the scarab, shimmering in green, blue, and purple with a metallic luster that combines bright and shadowy facets to create a stunningly graphic surface.

Look: With its beetle-like glow, Crystal Scarabaeus Green lends itself perfectly to nature-inspired and bold eco-designs. It powerfully mimics nature and sets a rebellious statement for any eco-warrior. However, its shiny surface also evokes an otherworldly appearance that echoes futuristic, stellar avant-garde looks. The metallic rainbow hue caters to the sporty sci-fi appeal that celebrates state-of-the-art technology and transports us into other dimensions.

FANCY STONES & SETTINGS

DESIGNER EDITION

4920 Kaputt Oval Fancy Stone



Size
23x18 mm
29x22.5 mm

- Crystal**
- Crystal F (001)
- Crystal Effects**
- Transparent Effects**
- Crystal AB F (001 AB)
- Crystal Golden Shadow F (001 GSHA)
- Crystal Red Magma F (001 REDM)
- Crystal Silver Night (001 SINI)
- Crystal Volcano F (001 VOL)
- Metallic Effects**
- Crystal Dorado F (001 DOR)
- Crystal Light Chrome F (001 LTCH)
- Crystal Metallic Blue F (001 METBL)
- Crystal Metallic Light Gold F (001 MLGLD)
- Crystal Scarabaeus Green*** F (001 SCGR)

4921 Kaputt Oval Fancy Stone



Size
23x18 mm
29x22.5 mm

- Crystal**
- Crystal F (001)
- Crystal Effects**
- Transparent Effects**
- Crystal AB F (001 AB)
- Crystal Golden Shadow F (001 GSHA)
- Crystal Red Magma F (001 REDM)
- Crystal Silver Night (001 SINI)
- Crystal Volcano F (001 VOL)
- Metallic Effects**
- Crystal Dorado F (001 DOR)
- Crystal Light Chrome F (001 LTCH)
- Crystal Metallic Blue F (001 METBL)
- Crystal Metallic Light Gold F (001 MLGLD)
- Crystal Scarabaeus Green*** F (001 SCGR)

4921/S¹

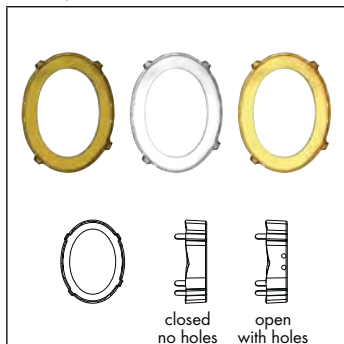

Size & color of plating
23x18 mm Unplated
29x22.5 mm Unplated
23x18 mm Rhodium
29x22.5 mm Rhodium
23x18 mm Gold
29x22.5 mm Gold

- Ring/Hole, Back Configuration**
- 00 C = No ring/hole, closed
- H2 O = 4 holes/2 each side, open

*** designed by Jean Paul Gaultier

¹ The Setting 4921/S for article 4921 can also be used for article 4920.

4922 Kaputt Fancy Stone

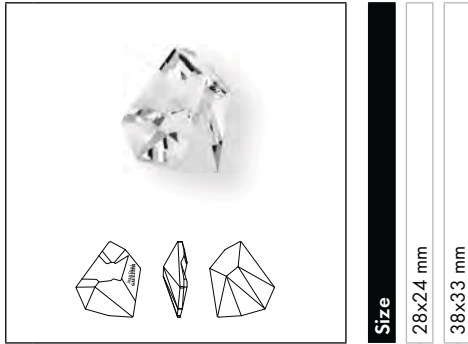

Crystal	
<input type="checkbox"/> Crystal F (001)	<input type="checkbox"/>
Crystal Effects	
Transparent Effects	
<input type="checkbox"/> Crystal AB F (001 AB)	<input type="checkbox"/>
<input type="checkbox"/> Crystal Golden Shadow F (001 GSHA)	<input type="checkbox"/>
<input type="checkbox"/> Crystal Red Magma F (001 REDM)	<input type="checkbox"/>
<input type="checkbox"/> Crystal Silver Night (001 SINI)	<input type="checkbox"/>
<input type="checkbox"/> Crystal Volcano F (001 VOL)	<input type="checkbox"/>
Metallic Effects	
<input type="checkbox"/> Crystal Dorado F (001 DOR)	<input type="checkbox"/>
<input type="checkbox"/> Crystal Light Chrome F (001 LTCH)	<input type="checkbox"/>
<input type="checkbox"/> Crystal Metallic Blue F (001 METBL)	<input type="checkbox"/>
<input type="checkbox"/> Crystal Metallic Light Gold F (001 MLGLD)	<input type="checkbox"/>
<input type="checkbox"/> Crystal Scarabaeus Green*** F (001 SCGR)	<input type="checkbox"/>

4923 Kaputt Fancy Stone



Crystal	
<input type="checkbox"/> Crystal F (001)	<input type="checkbox"/>
Crystal Effects	
Transparent Effects	
<input type="checkbox"/> Crystal AB F (001 AB)	<input type="checkbox"/>
<input type="checkbox"/> Crystal Golden Shadow F (001 GSHA)	<input type="checkbox"/>
<input type="checkbox"/> Crystal Red Magma F (001 REDM)	<input type="checkbox"/>
<input type="checkbox"/> Crystal Silver Night (001 SINI)	<input type="checkbox"/>
<input type="checkbox"/> Crystal Volcano F (001 VOL)	<input type="checkbox"/>
Metallic Effects	
<input type="checkbox"/> Crystal Dorado F (001 DOR)	<input type="checkbox"/>
<input type="checkbox"/> Crystal Light Chrome F (001 LTCH)	<input type="checkbox"/>
<input type="checkbox"/> Crystal Metallic Blue F (001 METBL)	<input type="checkbox"/>
<input type="checkbox"/> Crystal Metallic Light Gold F (001 MLGLD)	<input type="checkbox"/>
<input type="checkbox"/> Crystal Scarabaeus Green*** F (001 SCGR)	<input type="checkbox"/>

4923/S¹

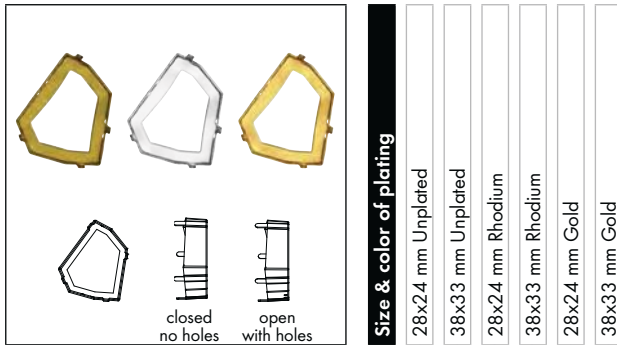

Ring/Hole, Back Configuration	
<input type="checkbox"/> 00 C = No ring/hole, closed	<input type="checkbox"/>
<input type="checkbox"/> H2 O = 4 holes/2 each side, open	<input type="checkbox"/>

*** designed by Jean Paul Gaultier

¹ The Setting 4923/S for article 4923 can also be used for article 4922.

FANCY STONES & SETTINGS

DESIGNER EDITION

4924 Kaputt Baguette Fancy Stone

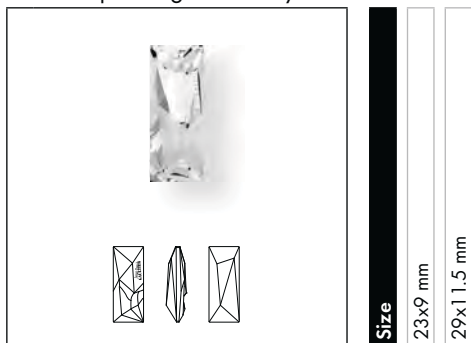

Size
23x9 mm
29x11.5 mm

- Crystal**
- Crystal F (001)
- Crystal Effects**
- Transparent Effects**
- Crystal AB F (001 AB)
- Crystal Golden Shadow F (001 GSHA)
- Crystal Red Magma F (001 REDM)
- Crystal Silver Night (001 SINI)
- Crystal Volcano F (001 VOL)
- Metallic Effects**
- Crystal Dorado F (001 DOR)
- Crystal Light Chrome F (001 LTCH)
- Crystal Metallic Blue F (001 METBL)
- Crystal Metallic Light Gold F (001 MLGLD)
- Crystal Scarabaeus Green*** F (001 SCGR)

4925 Kaputt Baguette Fancy Stone

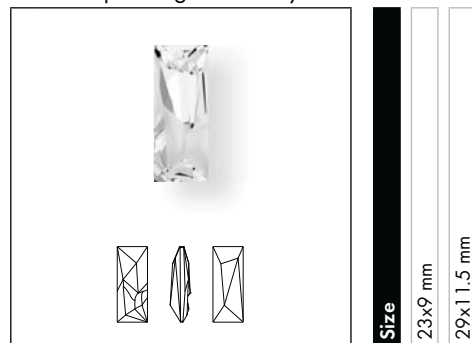

Size
23x9 mm
29x11.5 mm

- Crystal**
- Crystal F (001)
- Crystal Effects**
- Transparent Effects**
- Crystal AB F (001 AB)
- Crystal Golden Shadow F (001 GSHA)
- Crystal Red Magma F (001 REDM)
- Crystal Silver Night (001 SINI)
- Crystal Volcano F (001 VOL)
- Metallic Effects**
- Crystal Dorado F (001 DOR)
- Crystal Light Chrome F (001 LTCH)
- Crystal Metallic Blue F (001 METBL)
- Crystal Metallic Light Gold F (001 MLGLD)
- Crystal Scarabaeus Green*** F (001 SCGR)

4925/S¹

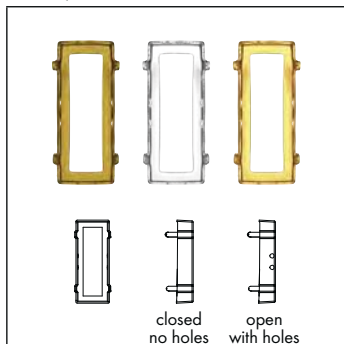

Size & color of plating
23x9 mm Unplated
29x11.5 mm Unplated
23x9 mm Rhodium
29x11.5 mm Rhodium
23x9 mm Gold
29x11.5 mm Gold

- Ring/Hole, Back Configuration**
- 00 C = No ring/hole, closed
 - H2 O = 4 holes/2 each side, open

*** designed by Jean Paul Gaultier

¹ The Setting 4925/S for article 4925 can also be used for article 4924.

THE KAPUTT DESIGNER EDITION FAMILY



4920 Kaputt Oval
Fancy Stone
23x18, 29x22.5 mm

chapter 02 Fancy Stones & Settings
p. 166



4921 Kaputt Oval
Fancy Stone
23x18, 29x22.5 mm

chapter 02 Fancy Stones & Settings
p. 166



4921/S¹
23x18, 29x22.5 mm

chapter 02 Fancy Stones & Settings
p. 166



4922 Kaputt Fancy
Stone
28x24, 38x33 mm

chapter 02 Fancy Stones & Settings
p. 167



4923 Kaputt Fancy
Stone
28x24, 38x33 mm

chapter 02 Fancy Stones & Settings
p. 167



4923/S²
28x24, 38x33 mm

chapter 02 Fancy Stones & Settings
p. 167



4924 Kaputt Baguette
Fancy Stone
23x9, 29x11.5 mm

chapter 02 Fancy Stones & Settings
p. 168



4925 Kaputt Baguette
Fancy Stone
23x9, 29x11.5 mm

chapter 02 Fancy Stones & Settings
p. 168



4925/S³
23x9, 29x11.5 mm

chapter 02 Fancy Stones & Settings
p. 168



6910 Kaputt Oval
Pendant
26, 36 mm

chapter 06 Pendants
p. 331



6911 Kaputt Oval
Pendant
26, 36 mm

chapter 06 Pendants
p. 331



6912 Kaputt Pendant
28, 40 mm

chapter 06 Pendants
p. 332



6913 Kaputt Pendant
28, 40 mm

chapter 06 Pendants
p. 332

DESIGNER EDITIONS - DISTINCT PACKAGING

This Designer Edition will be labelled with the
"Designer Edition" imprint directly on the packaging.

¹ The Setting 4921/S for article 4921 can also be used for article 4920

² The Setting 4923/S for article 4923 can also be used for article 4922

³ The Setting 4925/S for article 4925 can also be used for article 4924

FANCY STONES & SETTINGS

DESIGNER EDITION

TRIBUTE TO TRIBE COLLECTION
DESIGNED BY CÉLINE COUSTEAU

Design Story: Céline Cousteau, the granddaughter of legendary ocean explorer Jacques-Yves Cousteau, is a celebrated filmmaker, environmentalist, and like Daniel Swarovski a genuine humanitarian. Having been raised with a deep-rooted respect for our planet and all its inhabitants – both in the water and on the land – Céline Cousteau recently took up a project in the Brazilian Amazon region, where she has become an ambassador for an indigenous tribe of roughly 6,000 people living in an area the size of Austria. These tribe members – about

one-third of them considered “uncontacted” – have chosen Céline Cousteau to tell their story.

Her designs are inspired by tribal patterns either painted or tattooed on bare skin. They are symbolic of a pristine coexistence with nature and as such are part of a long tradition in which it has always been natural for man to decorate himself, be it for reasons of aesthetics, status, or celebration.

4926 Oval Tribe Fancy Stone



Size

14x10 mm

19x14 mm

Crystal Effects

Transparent Effects

Crystal AB Z F (001 AB)

Color Effects

Metallic Effects

Aquamarine Metallic Blue Z F (202 METBL)

Graphite Light Chrome Z F (253 LTCH)

Light Siam Metallic Light Gold Z F (227 MLGLD)

Peridot *Scarabaeus Green**** Z F (214 SCGR)

Topaz Dorado Z F (203 DOR)

4926/S

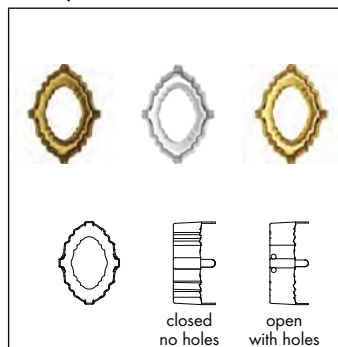

Size & color of plating

14x10 mm Unplated

19x14 mm Unplated

14x10 mm Rhodium

19x14 mm Rhodium

14x10 mm Gold

19x14 mm Gold

Ring/Hole, Back Configuration

00 C = No ring/hole, closed

H2 O = 4 holes/2 each side, open

*** designed by Jean Paul Gaultier

4927 Rhombus Tribe Fancy Stone



Crystal Effects		
Transparent Effects		
Crystal AB Z F (001 AB)	<input type="checkbox"/>	<input type="checkbox"/>
Color Effects		
Metallic Effects		
Aquamarine Metallic Blue Z F (202 METBL)	<input type="checkbox"/>	<input type="checkbox"/>
Graphite Light Chrome Z F (253 LTCH)	<input type="checkbox"/>	<input type="checkbox"/>
Light Siam Metallic Light Gold Z F (227 MLGLD)	<input type="checkbox"/>	<input type="checkbox"/>
Peridot Scarabaeus Green*** Z F (214 SCGR)	<input type="checkbox"/>	<input type="checkbox"/>
Topaz Dorado Z F (203 DOR)	<input type="checkbox"/>	<input type="checkbox"/>



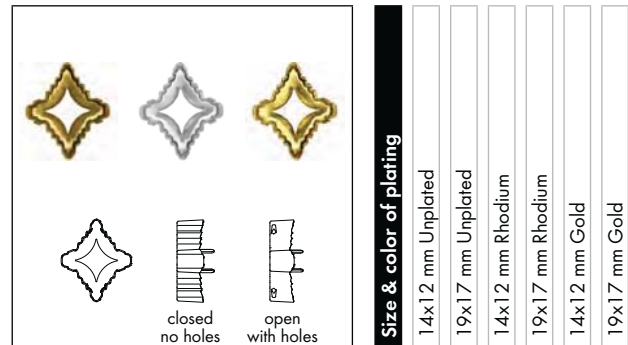

4927/S



Size & color of plating	<input type="checkbox"/>	<input type="checkbox"/>	<input type="checkbox"/>	<input type="checkbox"/>	<input type="checkbox"/>	<input type="checkbox"/>
14x12 mm Unplated						
19x17 mm Unplated						
14x12 mm Rhodium						
19x17 mm Rhodium						
14x12 mm Gold						
19x17 mm Gold						

Ring/Hole, Back Configuration						
00 C = No ring/hole, closed	<input type="checkbox"/>	<input type="checkbox"/>	<input type="checkbox"/>	<input type="checkbox"/>	<input type="checkbox"/>	<input type="checkbox"/>
H2 O = 4 holes/2 each side, open	<input type="checkbox"/>	<input type="checkbox"/>	<input type="checkbox"/>	<input type="checkbox"/>	<input type="checkbox"/>	<input type="checkbox"/>

THE CÉLINE COUSTEAU
DESIGNER EDITION FAMILY

- 
4926 Oval Tribe Fancy Stone
14x10, 19x14 mm
chapter 02 Fancy Stones & Settings p. 170
- 
4926/S
14x10, 19x14 mm
chapter 02 Fancy Stones & Settings p. 170
- 
4927 Rhombus Tribe Fancy Stone
14x12, 19x17 mm
chapter 02 Fancy Stones & Settings p. 171
- 
4927/S
14x12, 19x17 mm
chapter 02 Fancy Stones & Settings p. 171

- 
6868 Cross Tribe Pendant
14, 24 mm
chapter 06 Pendants p. 328

DESIGNER EDITIONS - DISTINCT PACKAGING

This Designer Edition will be labelled with the "Designer Edition" imprint directly on the packaging.

*** designed by Jean Paul Gaultier

FANCY STONES & SETTINGS

PRODUCT DETAILS

Article Size	Packing Unit = Minimum Order Quantity in Pieces	Average Net Weight in Grams per Packing Unit Crystal (001)	Average Gross Weight in Grams per Packing Unit Crystal (001)
4120			
6x4 mm	360	31.2	42.1
8x6 mm	180	44.7	45.2
14x10 mm	144	170.2	193.8
18x13 mm	48	112.3	132.9
25x18 mm	24	152.2	177.6
4120/S			
6x4 mm	360		41.9
8x6 mm	180		41.6
14x10 mm	144		86.0
18x13 mm	48		49.5
25x18 mm	24		48.8
4122			
8x6 mm	180	41.1	42.5
14x10.5 mm	108	127.0	150.5
18x13,5 mm	48	95.6	115.0
4122/S			
8x6 mm	180		41.8
14x10.5 mm	108		105.5
18x13,5 mm	48		79.0
4127			
30x22 mm	24	173.6	218.7
39x28 mm	12	226.8	246.4
4127/S			
30x22 mm	24		53.0
39x28 mm	12		64.4
4128			
6x4 mm	360	26.8	37.6
8x6 mm	360	76.5	87.3
10x8 mm	144	59.9	80.2
14x10 mm	144	105.6	129.2
4128/S			
6x4 mm	360		40.7
8x6 mm	360		79.3
10x8 mm	144		80.0
14x10 mm	144		86.0
4137			
15x11 mm	72	48.2	66.4
4139			
14 mm	72	53.2	82.7
20 mm	24	46.7	78.7
30 mm	18	124.6	153.0
4161			
15x5 mm	72	29.5	51.6
21x7 mm	48	71.5	96.5
27x9 mm	24	65.8	94.2
4161/S			
15x5 mm	72		24.3
21x7 mm	48		27.0
27x9 mm	24		21.5

FANCY STONES & SETTINGS

Article Size	Packing Unit = Minimum Order Quantity in Pieces	Average Net Weight in Grams per Packing Unit Crystal (001)	Average Gross Weight in Grams per Packing Unit Crystal (001)
4195			
14 mm	24	33.1	53.8
18 mm	15	44.4	69.2
22 mm	6	31.4	52.8
4195/S			
14 mm	24		31.7
18 mm	15		33.1
22 mm	6		24.1
4196			
23x20 mm	16	113.2	141.2
30x26 mm	12	192.1	215.2
4196/S			
23x20 mm	16		41.8
30x26 mm	12		49.1
4200			
11x3 mm	360	28.6	39.4
15x4 mm	144	26.2	37.1
35x9.5 mm	16	41.9	63.8
48x13 mm	6	38.3	70.8
4200/S			
11x3 mm	360		64.9
15x4 mm	144		39.7
35x9.5 mm	16		34.1
48x13 mm	6		23.6
4224			
10x8 mm	144	51.4	63.3
14x11 mm	72	53.2	72.3
23x18 mm	36	59.8	79.4
4224/S			
10x8 mm	144		62.7
14x11 mm	72		55.5
23x18 mm	36		41.5
4227			
32x17 mm	24	100.8	123.4
4227/S			
32x17 mm	24		48.0
4228			
4x2 mm	720	9.2	18.3
5x2.5 mm	720	18.9	28.0
6x3 mm	720	30.5	39.6
8x4 mm	360	32.9	42.0
10x5 mm	360	60.7	72.1
15x7 mm	144	63.9	88.1
4228/S			
5x2.5 mm	720		49.6
6x3 mm	720		71.4
8x4 mm	360		52.8
10x5 mm	360		81.6
15x7 mm	144		85.8

FANCY STONES & SETTINGS

Article Size	Packing Unit = Minimum Order Quantity in Pieces	Average Net Weight in Grams per Packing Unit Crystal (001)	Average Gross Weight in Grams per Packing Unit Crystal (001)
4230			
14x9 mm	144	75.1	98.8
19x12 mm	72	86.5	113.9
23x15 mm	48	102.8	123.0
4230/S			
14x9 mm	144		57.6
19x12 mm	72		72.0
23x15 mm	48		72.0
4320			
6x4 mm	360	25.7	34.8
8x6 mm	180	30.7	39.8
10x7 mm	144	48.6	68.9
14x10 mm	144	126.6	150.2
18x13 mm	48	85.2	105.8
4320/S			
6x4 mm	360		43.9
8x6 mm	180		39.7
10x7 mm	144		72.0
14x10 mm	144		126.1
18x13 mm	48		54.6
4327			
30x20 mm	24	161.8	206.8
40x27 mm	12	201.6	226.3
4327/S			
30x20 mm	24		51.5
40x27 mm	12		63.7
4328			
6x3.6 mm	720	40.0	50.5
8x4.8 mm	360	42.1	53.0
10x6 mm	144	29.2	50.5
13x7.8 mm	144	65.1	88.3
4328/S			
6x3.6 mm	720		58.4
8x4.8 mm	360		57.1
10x6 mm	144		33.9
13x7.8 mm	144		51.2
4331			
11 mm	180	18.8	29.0
15 mm	96	20.4	50.0
20 mm	48	21.1	46.4
30 mm	24	36.0	58.4
4331/S			
11 mm	180		28.2
15 mm	96		27.5
20 mm	48		26.1
30 mm	24		36.8
4370			
11x10 mm	144	82.8	100.9
15.5x14 mm	72	107.3	127.4
20x18 mm	48	149.5	170.0

FANCY STONES & SETTINGS

Article Size	Packing Unit = Minimum Order Quantity in Pieces	Average Net Weight in Grams per Packing Unit Crystal (001)	Average Gross Weight in Grams per Packing Unit Crystal (001)
4370/S			
11x10 mm	144		78.6
15.5x14 mm	72		75.0
20x18 mm	48		77.1
4418			
6 mm	216	55.4	79.2
8 mm	216	119.9	147.8
4418/S			
6 mm	216		54.0
8 mm	216		138.2
4428			
1.5 mm	1,440	4.32	15.1
2 mm	1,440	12.2	23.0
3 mm	1,440	34.8	57.6
4 mm	1,440	108.5	119.5
5 mm	360	51.6	61.9
6 mm	360	88.55	93.0
8 mm	144	84.5	99.6
4428/S			
4 mm	1,440		104.5
5 mm	360		58.0
6 mm	360		50.0
8 mm	144		45.5
4439			
14 mm	72	88.0	111.6
20 mm	24	80.4	123.0
30 mm	12	127.6	145.8
4447			
6 mm	360	87.5	98.3
8 mm	144	71.5	91.9
10 mm	144	133.9	157.2
12 mm	72	117.6	137.9
4447/S			
6 mm	360		50.0
8 mm	144		47.0
10 mm	144		70.5
12 mm	72		56.0
4461			
8 mm	144	56.9	77.2
12 mm	72	84.4	103.4
16 mm	72	214.4	238.0
4461/S			
8 mm	144		62.7
12 mm	72		52.8
16 mm	72		92.0
4470			
10 mm	144	91.6	111.9
12 mm	72	74.7	92.9
18 mm	48	170.3	190.9
4470/S			
10 mm	144		54.5
12 mm	72		53.3
18 mm	48		92.0

FANCY STONES & SETTINGS

Article Size	Packing Unit = Minimum Order Quantity in Pieces	Average Net Weight in Grams per Packing Unit Crystal (001)	Average Gross Weight in Grams per Packing Unit Crystal (001)
4481			
12 mm	72	96.3	116.0
16 mm	48	140.2	160.0
4481/S			
12 mm	72		74.2
16 mm	48		85.3
4485			
6 mm	144	21.0	43.7
10.5 mm	96	81.6	103.6
17 mm	24	84.0	104.1
4485/S			
6 mm	144		33.9
10.5 mm	96		74.7
17 mm	24		52.8
4500			
3x2 mm	1,440	20.5	32.0
6x2 mm	720	18.4	27.5
10x3 mm	360	36.6	47.6
4500/S			
6x2 mm	720		61.3
10x3 mm	360		68.5
4501			
4x2 mm	720	16.8	25.9
5x2 mm	720	18.1	27.2
5x2.5 mm	720	20.9	30.0
7x3 mm	720	60.2	71.1
10x5 mm	360	96.2	106.9
4501/S			
5x2.5 mm	720		65.1
7x3 mm	720		58.0
10x5 mm	360		150.6
4502			
3x1 mm	720	2.2	11.4
4503			
4x2 mm	720	14.2	33.9
6.3x2.4 mm	720	34.5	54.5
4524			
12x6 mm	144	67.7	89.4
16x8 mm	72	78.0	102.7
23x11 mm	36	104.0	131.9
4524/S			
12x6 mm	144		77.1
16x8 mm	72		64.9
23x11 mm	36		60.6
4527			
8x6 mm	144	53.7	64.6
14x10 mm	72	122.4	144.9
18x13 mm	72	246.9	270.6
4527/S			
8x6 mm	144		45.5
14x10 mm	72		60.3
18x13 mm	72		104.5

FANCY STONES & SETTINGS

Article Size	Packing Unit = Minimum Order Quantity in Pieces	Average Net Weight in Grams per Packing Unit Crystal (001)	Average Gross Weight in Grams per Packing Unit Crystal (001)
4547			
15x5 mm	72	37.4	58.9
21x7 mm	48	65.3	98.7
24x8 mm	48	97.4	130.5
30x10 mm	24	101.0	124.4
4547/S			
15x5 mm	72		36.8
21x7 mm	48		43.5
24x8 mm	48		50.5
30x10 mm	24		39.0
4565			
14x10 mm	72	71.5	88.9
18x13 mm	48	101.2	121.8
4565/S			
14x10 mm	72		64.2
18x13 mm	48		69.9
4568			
8x6 mm	144	34.7	55.8
14x10 mm	72	74.9	103.1
18x13 mm	24	46.2	64.7
27x18 mm	20	105.8	132.7
4568/S			
8x6 mm	144		36.7
14x10 mm	72		54.0
18x13 mm	24		37.2
27x18 mm	20		61.0
4600			
6x4 mm	360	40.9	51.8
8x6 mm	144	41.2	52.2
10x8 mm	144	84.0	104.0
12x10 mm	144	146.7	170.3
4600/S			
6x4 mm	360		46.9
8x6 mm	144		39.7
10x8 mm	144		90.1
12x10 mm	144		127.5
4610			
14x10 mm	144	171.3	194.9
18x13 mm	48	124.9	145.5
20x15 mm	24	88.5	105.8
4610/S			
14x10 mm	144		104.5
18x13 mm	48		66.0
20x15 mm	24		51.0
4627			
27x18.5 mm	24	125.3	170.8
37x25.5 mm	12	170.7	197.8
4627/S			
27x18.5 mm	24		54.0
37x25.5 mm	12		60.1

FANCY STONES & SETTINGS

Article Size	Packing Unit = Minimum Order Quantity in Pieces	Average Net Weight in Grams per Packing Unit Crystal (001)	Average Gross Weight in Grams per Packing Unit Crystal (001)
4675			
23 mm	24	175.4	220.5
4675/S			
23 mm	24		73.8
4678			
8 mm	144	42.4	51.6
14 mm	48	81.3	102.7
23 mm	16	98.8	121.3
4678/S			
8 mm	144		37.4
14 mm	48		38.4
23 mm	16		49.6
4681			
14 mm	72	88.5	108.2
18 mm	48	121.3	141.1
4681/S			
14 mm	72		69.2
18 mm	48		75.2
4706			
7 mm	144	23.7	44.4
12 mm	72	61.5	83.9
17 mm	48	96.4	119.8
24 mm	16	109.1	145.7
4706/S			
7 mm	144		28.8
12 mm	72		36.0
17 mm	48		81.6
24 mm	16		48.0
4717			
15.5 mm	72	139.9	148.3
21.5 mm	32	152.8	161.8
4717/S			
15.5 mm	72		86.0
21.5 mm	32		54.0
4722			
4 mm	480	12.0	21.1
6 mm	180	16.4	25.5
8 mm	144	29.0	48.1
10 mm	144	61.4	84.4
4722/S			
4 mm	480		40.2
6 mm	180		46.9
8 mm	144		45.1
10 mm	144		74.3
4731			
10x5 mm	144	22.5	40.7
14x7 mm	96	38.6	56.8
18x9 mm	48	40.5	60.8
23x11.5 mm	30	54.2	79.5

FANCY STONES & SETTINGS

Article Size	Packing Unit = Minimum Order Quantity in Pieces	Average Net Weight in Grams per Packing Unit Crystal (001)	Average Gross Weight in Grams per Packing Unit Crystal (001)
4731/S			
10x5 mm	144		32.4
14x7 mm	96		35.3
18x9 mm	48		29.5
23x11.5 mm	30		28.6
4739			
14x11 mm	144	143.7	170.4
20x16 mm	72	200.7	229.8
4739/S			
14x11 mm	144		117.5
20x16 mm	72		112.3
4744			
6 mm	720	62.3	72.8
10 mm	288	126.0	158.1
4744/S			
6 mm	720		104.5
10 mm	288		93.0
4745			
5 mm	720	35.6	46.4
10 mm	144	48.5	71.3
4745/S			
5 mm	720		75.2
10 mm	144		43.0
4748			
5 mm	720	72.0	80.6
10 mm	288	195.8	241.9
4748/S			
5 mm	720		90.7
10 mm	288		162.1
4753			
14 mm	36	32.6	53.2
18 mm	24	42.9	60.3
23 mm	18	71.9	101.5
4753/S			
14 mm	36		34.6
18 mm	24		36.3
23 mm	18		44.9
4753/G			
14 mm	36	32.5	53.1
18 mm	24	47.6	64.9
23 mm	18	71.7	101.3
4753/S			
14 mm	36		34.6
18 mm	24		36.3
23 mm	18		44.9
4756			
19x11.5 mm	96	112.5	171.3
27x16 mm	40	152.0	194.0
39x23.5 mm	24	226.2	258.1

FANCY STONES & SETTINGS

Article Size	Packing Unit = Minimum Order Quantity in Pieces	Average Net Weight in Grams per Packing Unit Crystal (001)	Average Gross Weight in Grams per Packing Unit Crystal (001)
4756/S			
19x11.5 mm	96		84.3
27x16 mm	40		66.1
39x23.5 mm	24		72.3
4757			
14x8.5 mm	96	82.6	104.8
19x11.5 mm	96	182.4	211.6
4757/S			
14x8.5 mm	96		65.2
19x11.5 mm	96		125.6
4773			
14x7.5 mm	72	43.1	64.8
18x9.5 mm	48	56.4	78.5
28x15 mm	20	90.7	111.1
4773/S			
14x7.5 mm	72		28.8
18x9.5 mm	48		48.0
28x15 mm	20		41.2
4778			
18x13.7 mm	48	48.0	73.4
4778/S			
18x13.7 mm	48		45.5
4779			
18x15.6 mm	48	70.4	96.9
4779/S			
18x15.6 mm	48		67.0
4784			
8 mm	144	47.9	51.5
14 mm	72	57.7	81.1
23 mm	30	100.2	127.2
4784/S			
8 mm	144		46.9
14 mm	72		65.6
23 mm	30		73.1
4785			
14 mm	36	33.9	55.0
19 mm	15	36.0	58.0
23 mm	15	61.3	82.2
4785/S			
14 mm	36		39.3
19 mm	15		32.2
23 mm	15		43.3
4789			
14 mm	72	100.8	129.2
23 mm	32	188.8	225.6
29 mm	18	214.2	242.9
4789/S			
14 mm	72		60.6
23 mm	32		70.9
29 mm	18		62.0

FANCY STONES & SETTINGS

Article Size	Packing Unit = Minimum Order Quantity in Pieces	Average Net Weight in Grams per Packing Unit Crystal (001)	Average Gross Weight in Grams per Packing Unit Crystal (001)
4790			
18x7.5 mm	108	72.3	97.1
23x10 mm	36	48.2	71.9
32x13.5 mm	30	105.5	139.5
4790/S			
18x7.5 mm	108		85.9
23x10 mm	36		47.7
32x13.5 mm	30		75.5
4795			
14 mm	72	72.0	106.9
19 mm	48	124.8	152.5
28 mm	24	204.0	254.8
4795/S			
14 mm	72		63.5
19 mm	48		80.5
28 mm	24		78.1
4809			
13x12 mm	72	47.8	68.5
17x15.5 mm	48	63.3	84.8
27x25 mm	16	86.3	100.0
4809/S			
13x12 mm	72		36.0
17x15.5 mm	48		48.0
27x25 mm	16		28.8
4810			
13x12 mm	72	48.4	69.1
4810/S			
13x12 mm	72		36.0
4827			
28 mm	24	214.9	253.3
4827/S			
28 mm	24		55.5
4831			
5.5x5 mm	360	26.5	37.3
8.8x8 mm	144	40.0	60.4
11x10 mm	144	80.1	101.5
4831/S			
5.5x5 mm	360		50.0
8.8x8 mm	144		46.9
11x10 mm	144		97.3
4841			
4 mm	288	45.3	66.6
6 mm	144	77.2	95.3
8 mm	72	89.2	107.4
4869			
4 mm	480	36.2	45.3
6 mm	180	47.2	56.4
8 mm	144	90.8	109.0

FANCY STONES & SETTINGS

Article Size	Packing Unit = Minimum Order Quantity in Pieces	Average Net Weight in Grams per Packing Unit Crystal (001)	Average Gross Weight in Grams per Packing Unit Crystal (001)
4876			
18x11.5 mm	24	33.9	52.4
30x19 mm	10	45.2	66.9
4876/S			
18x11.5 mm	24		26.7
30x19 mm	10		24.7
4878			
18x11.5 mm	24	24.5	44.7
30x19 mm	10	51.4	73.2
4878/S			
18x11.5 mm	24		26.7
30x19 mm	10		24.7
4884			
5.5x5 mm	360	39.0	49.7
6.6x6 mm	360	67.2	78.0
8.8x8 mm	288	111.4	138.1
11x10 mm	144	107.3	127.4
15.4x14 mm	72	128.7	149.3
4884/S			
5.5x5 mm	360		49.6
6.6x6 mm	360		72.1
8.8x8 mm	288		46.9
11x10 mm	144		101.6
15.4x14 mm	72		103.1
4920			
23x18 mm	15	63.3	88.0
29x22.5 mm	8	65.7	86.1
4921			
23x18 mm	15	63.3	88.0
29x22.5 mm	8	65.7	86.1
4921/S			
23x18 mm	15		31.6
29x22.5 mm	8		25.7
4922			
28x24 mm	8	38.9	60.0
38x33 mm	6	69.8	93.4
4923			
28x24 mm	8	38.9	60.0
38x33 mm	6	69.8	93.4
4923/S			
28x24 mm	8		25.2
38x33 mm	6		29.2
4924			
23x9 mm	20	37.6	60.2
29x11.5 mm	12	49.1	69.7

FANCY STONES & SETTINGS

Article Size	Packing Unit = Minimum Order Quantity in Pieces	Average Net Weight in Grams per Packing Unit Crystal (001)	Average Gross Weight in Grams per Packing Unit Crystal (001)
4925			
23x9 mm	20	37.6	60.2
29x11.5 mm	12	49.1	69.7
4925/S			
23x9 mm	20		32.3
29x11.5 mm	12		30.5
4926			
14x10 mm	36	27.6	45.1
19x14 mm	24	47.0	63.0
4926/S			
14x10 mm	36		42.1
19x14 mm	24		48.3
4927			
14x12 mm	36	37.9	20.4
19x17 mm	24	44.2	26.6
4927/S			
14x12 mm	36		34.6
19x17 mm	24		39.6

SWAROVSKI

CERTIFICATE

H. J. HOFERT, S.L.

meets the high standards set by Swarovski® and has therefore been certified as a

SWAROVSKI

AUTHORIZED WHOLESALER

This Authorized Wholesaler offers you:

- An extensive selection of high quality Swarovski crystals
- Good product knowledge on the brand Swarovski
- Flexibility and professionalism in customer service

The staff of this Authorized Wholesaler will be happy to inform you about Swarovski and the latest brand and presentation materials.

The certification is based on a sustainable business relationship with Swarovski and on the agreement of defined standards.

04.10.2016

01.10.2017

DATE AND PLACE OF ISSUE

EXPIRY DATE

SWAROVSKI

Swarovski's suggestions for Authorized Wholesalers are recommendations based on Swarovski's actual experience, current knowledge, and the information provided by the Authorized Wholesaler. Such advice does not prevent you from carrying out your own audits, examination, and selection. The selection of an Authorized Wholesaler is solely the customer's responsibility.