



06

PENDANTS

Pendants have timeless elegance and are available in a large range of classical and avant-garde cuts and shapes, as well as in many colors and effects. Pendants offer a whole range of design possibilities for different segments thanks to their easy application, with the top hole requiring only a jump ring/pinch bail with a chain or cord. Due to the diverse range of sizes available, Pendants are ideal for creating jewelry sets such as necklaces, bracelets, and earrings.

In addition, a completely new pendant concept is now available: the half hole pendants. The customer can decide whether to buy the finished pendant with different metal pin shapes or the crystal alone, allowing customers to express their creativity with a customized metal part or the metal pin itself.

COLORS & EFFECTS

OPEN TO SEE COLORS & EFFECTS

COLORS



EFFECTS



NUMERICAL ORDER

001	Crystal	001 SAH	Crystal Sahara*	228	Olivine
001 AB	Crystal Aurora Boreale	001 SAT	Crystal Satin*	229	Blue Zircon
001 ANTP	Crystal Antique Pink*	001 SCGR	Crystal Scarabaeus Green*/***	231	Yellow Opal
001 API	Crystal Astral Pink	001 SINI	Crystal Silver Night**	234	White Opal
001 BBL	Crystal Bermuda Blue**	001 SILPA	Crystal Silver Patina*	237	Fireopal
001 BLAPA	Crystal Black Patina*	001 SSHA	Crystal Silver Shade	243	Capri Blue
001 BLSH	Crystal Blue Shade*	001 VL	Crystal Vitrail Light**	253	Graphite
001 BRSH	Crystal Bronze Shade*	001 VM	Crystal Vitrail Medium**	257	Blush Rose
001 CAL	Crystal Comet Argent Light*	001 VOL	Crystal Volcano**	262	Rose Peach
001 DOR	Crystal Dorado*	001 WHIPA	Crystal White Patina	263	Light Turquoise
001 GOLPA	Crystal Gold Patina*	202	Aquamarine	265	Smoky Mauve
001 GSHA	Crystal Golden Shadow	203	Topaz	266	Denim Blue
001 HEL	Crystal Heliotrope**	204	Amethyst	280	Jet
001 IRIG	Crystal Iridescent Green*	205	Emerald	283	Provence Lavender
001 LTCH	Crystal Light Chrome*	206	Sapphire	291	Fern Green
001 LISH	Crystal Lilac Shadow	207	Montana	294	Chrysolite Opal
001 LUMG	Crystal Luminous Green*	208	Siam	319	Vintage Rose
001 METBL	Crystal Metallic Blue*	209	Rose	360	Erinite
001 METSH	Crystal Metallic Sunshine*	211	Light Sapphire	371	Violet
001 MLGLD	Crystal Metallic Light Gold*	212	Light Amethyst	379	Indicolite
001 MOL	Crystal Moonlight	214	Peridot	501	Ruby
001 PARSH	Crystal Paradise Shine	215	Black Diamond	502	Fuchsia
001 RABDK	Crystal Rainbow Dark*	217	Indian Sapphire	508	Rosaline
001 REDM	Crystal Red Magma*	223	Light Rose	539	Tanzanite
001 ROGL	Crystal Rose Gold*	225	Smoky Quarz	542	Padparadscha
001 ROGL2	Crystal Rose Gold 2x*	226	Light Topaz		
001 ROSPA	Crystal Rose Patina*	227	Light Siam		

ALPHABETICAL ORDER

Amethyst (204)	Crystal Moonlight (001 MOL)	Light Amethyst (212)
Aquamarine (202)	Crystal Paradise Shine (001 PARSH)	Light Rose (223)
Black Diamond (215)	Crystal Rainbow Dark (001 RABDK)*	Light Sapphire (211)
Blue Zircon (229)	Crystal Red Magma (001 REDM)*	Light Siam (227)
Blush Rose (257)	Crystal Rose Gold (001 ROGL)*	Light Topaz (226)
Capri Blue (243)	Crystal Rose Gold 2x (001 ROGL2)*	Light Turquoise (263)
Chrysolite Opal (294)	Crystal Rose Patina (001 ROSPA)*	Montana (207)
Crystal (001)	Crystal Sahara (001 SAH)*	Olivine (228)
Crystal Antique Pink (001 ANTP)*	Crystal Satin (001 SAT)*	Padparadscha (542)
Crystal Astral Pink (001 API)	Crystal Scarabaeus Green (001 SCGR)*/***	Peridot (214)
Crystal Aurora Boreale (001 AB)	Crystal Silver Night (001 SINI)**	Provence Lavender (283)
Crystal Bermuda Blue (001 BBL)**	Crystal Silver Patina (001 SILPA)*	Rosaline (508)
Crystal Black Patina (001 BLAPA)*	Crystal Silver Shade (001 SSHA)	Rose (209)
Crystal Blue Shade (001 BLSH)*	Crystal Vitrail Light (001 VL)**	Rose Peach (262)
Crystal Bronze Shade (001 BRSH)*	Crystal Vitrail Medium (001 VM)**	Ruby (501)
Crystal Comet Argent Light (001 CAL)*	Crystal Volcano (001 VOL)**	Sapphire (206)
Crystal Dorado (001 DOR)*	Crystal White Patina (001 WHIPA)	Siam (208)
Crystal Gold Patina (001 GOLPA)*	Denim Blue (266)	Smoky Mauve (265)
Crystal Golden Shadow (001 GSHA)	Emerald (205)	Smoky Quarz (225)
Crystal Heliotrope (001 HEL)**	Erinite (360)	Tanzanite (539)
Crystal Iridescent Green (001 IRIG)*	Fern Green (291)	Topaz (203)
Crystal Light Chrome (001 LTCH)*	Fireopal (237)	Violet (371)
Crystal Lilac Shadow (001 LISH)	Fuchsia (502)	Vintage Rose (319)
Crystal Luminous Green (001 LUMG)*	Graphite (253)	White Opal (234)
Crystal Metallic Blue (001 METBL)*	Indian Sapphire (217)	Yellow Opal (231)
Crystal Metallic Light Gold (001 MLGLD)*	Indicolite (379)	
Crystal Metallic Sunshine (001 METSH)*	Jet (280)	

CRYSTAL PATINA



For details on available colors and effects for each article within the product groups, please see the product matrix of the respective item in the Collection 2016.
For color and effect samples, please see the corresponding color chart.

Classic Colors/Effects:
This color range offers a wide choice of traditional Swarovski crystal colors and effects.

Exclusive Colors/Effects:
This color range is offered exclusively by Swarovski.

The plating resistance of effects is tested according to Swarovski's plating guidelines (SWAROVSKI.COM/PROFESSIONAL). Customers are advised to carry out their own tests if customers' plating parameters diverge from Swarovski plating guidelines.

* Crystals are not resistant to plating and similar processing.
** Crystals are resistant to plating only if they are F-failed.
*** designed by Jean Paul Gaultier

Colors and effects can appear different when illuminated with different light sources. Swarovski uses standard light source D50 for color decision and comparison. Slight changes in shades are unavoidable. Colors may vary according to cut and foiling.

The composition of Advanced Crystal is compliant with regulatory industry norms and laws regarding the restriction or prohibition of certain substances in the most relevant segments of our customers. Please note that the compliance of the crystal colors Citrine, Fireopal, Hyacinth, Light Siam, Siam and Yellow Opal vary to certain industry regulations. Those regulations are indicated with an (*) in the compliance overview. Indian Siam (option to Lt. Siam) and Tangerine (option to Sun) conform to all CLEAR-lists.











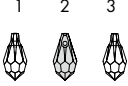
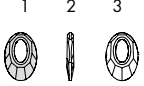
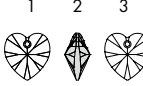

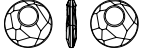

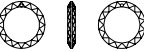



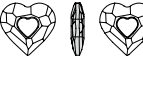







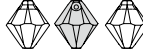

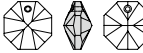

For further information please visit swarovski.com/professional

© 2016 D. Swarovski Distribution GmbH

PENDANTS

PENDANTS

SUMMARY

 <p>6000 11x5.5, 13x6.5, 15x7.5, 22x11, 28x14 mm</p>	 <p>6040 20, 30, 40 mm</p>	 <p>6228 10.3x10, 14.4x14, 18x17.5, 28, 40 mm</p>
 <p>6002 10x7, 15x11.5 mm</p>	 <p>6041 18, 28, 38 mm</p>	 <p>6240 12, 17, 27, 37 mm</p>
 <p>6007 7x4, 9x5 mm</p>	 <p>6049 20, 30 mm</p>	<p>DESIGNER EDITION</p>  <p>6261 17, 27, 36 mm</p>
 <p>6010 11x5.5, 13x6.5, 17x8.5, 21x10.5, 50x21.5 mm</p>	 <p>6090 16x11, 22x15 mm</p>	<p>DESIGNER EDITION</p>  <p>6262 17, 26, 34 mm</p>
 <p>6012 11x10, 15.4x14 mm</p>	 <p>6100 24x12 mm</p>	<p>DESIGNER EDITION</p>  <p>6264 18, 28 mm</p>
 <p>6015 17, 21, 50 mm</p>	 <p>6106 16, 22, 28, 38, 50 mm</p>	 <p>6320 14, 19, 27 mm</p>
<p>DESIGNER EDITION</p>  <p>6017/G 30, 56 mm</p>	 <p>6110 30x14, 40x18 mm</p>	 <p>6328 6, 8 mm</p>
<p>DESIGNER EDITION</p>  <p>6019/G 35 mm</p>	 <p>6128 8, 10, 12 mm</p>	 <p>6401 8, 12 mm</p>
 <p>6020 18, 30, 37 mm</p>	 <p>6150 30, 50 mm</p>	 <p>6428 6, 8, 12 mm</p>
 <p>6022 14, 24, 33 mm</p>	 <p>6210 12, 17 mm</p>	 <p>6460 20 mm</p>
 <p>6028 8, 10, 12, 18 mm</p>	 <p>6215 18 mm</p>	 <p>6465 13.5x6, 25x7, 38x10 mm</p>
 <p>6039 25, 38 mm</p>	 <p>6225 10, 18, 28 mm</p>	 <p>6470 32, 40 mm</p>

1 Front view 2 Side view 3 Back view

"1 Front view" or "3 Back view" highlighted in gray: surface effect is applied to this side.

"2 Side view" highlighted in gray: side of surface effect not defined. (for all symmetrical and some asymmetrical articles).

Where all views are highlighted in gray, the effect is applied over the entire marked surface.

PENDANTS

SUMMARY



6480
18, 28, 39 mm

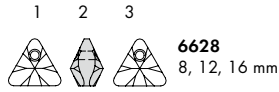

6628
8, 12, 16 mm



6722
16, 20, 30 mm

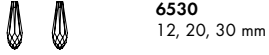

6530
12, 20, 30 mm



6650
22 mm



6723
16, 28 mm

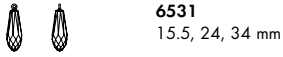

6531
15.5, 24, 34 mm



6656
19, 27, 39 mm



6724
12, 19, 33 mm

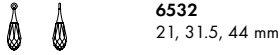

6532
21, 31.5, 44 mm



6670
18, 24, 50 mm



6724/G
12, 19, 33 mm



6533
17.5, 23, 33 mm



6673
18, 28, 38 mm



DESIGNER EDITION
6730
18x11.5, 34x22 mm

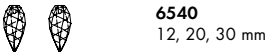

6540
12, 20, 30 mm



6680
14, 20, 40 mm



DESIGNER EDITION
6731
14, 28 mm



6541
14.5 mm



6685
19, 28 mm



6734
14, 23 mm



6541
24, 34.5 mm



6690
23, 27 mm



6735
26x16 mm

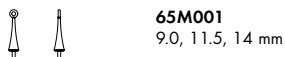

65M001
9.0, 11.5, 14 mm

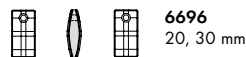

6696
20, 30 mm



6744
12, 14, 18 mm

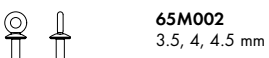

65M002
3.5, 4, 4.5 mm



6704
20, 25, 30 mm



6748
14, 18, 28 mm



65M003
2.5 mm



6714
20, 28, 40 mm



6748/G
14, 18, 28 mm



6621
18, 28 mm



6721
16, 20, 28, 40 mm



6754
18 mm

1 Front view 2 Side view 3 Back view

"1 Front view" or "3 Back view" highlighted in gray: the surface effect is applied to this side.

"2 Side view" highlighted in gray: side of surface effect not defined. (for all symmetrical and some assymetrical articles).

6721: 16, 20 mm: no defined side for surface effect; 28, 40 mm surface effect on "3 Back view".

6864: Reverse effect "V" is the standard version and is therefore highlighted.

PENDANTS

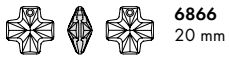
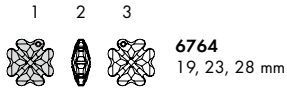

1 Front view 2 Side view 3 Back view

"1 Front view" or "3 Back view" highlighted in gray: the surface effect is applied to this side.

"2 Side view" highlighted in gray: side of surface effect not defined (for all symmetrical and some asymmetrical articles).

Where all views are highlighted in gray, the effect is applied over the entire marked surface.

PENDANTS

6000

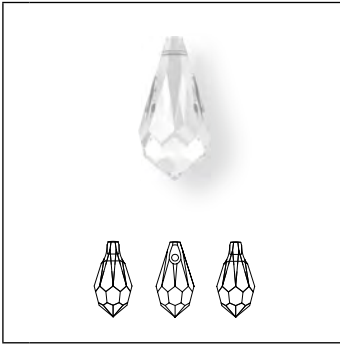

Size	11x5.5 mm	13x6.5 mm	15x7.5 mm	22x11 mm	28x14 mm
Crystal					
Crystal (001)	■	■	■	■	
Colors					
Plain Colors					
Amethyst (204)	■				
Aquamarine (202)	■				
Emerald (205)	■				
Graphite (253)	■	■			
Jet (280)	■	■	■		
Light Siam (227)	■				
Rose (209)	■				
Sapphire (206)	■				
Siam (208)	■	■	■		
Tanzanite (539)	■				
Topaz (203)	■				
Crystal Effects					
Transparent Effects					
Crystal AB (001 AB)	■	■	■	■	■
Crystal Paradise Shine (001 PARSH)	■	■	■		

- Crystal**
- Crystal (001)
- Colors**
- Plain Colors**
- Amethyst (204)
- Aquamarine (202)
- Emerald (205)
- Graphite (253)
- Jet (280)
- Light Siam (227)
- Rose (209)
- Sapphire (206)
- Siam (208)
- Tanzanite (539)
- Topaz (203)
- Crystal Effects**
- Transparent Effects**
- Crystal AB (001 AB)
- Crystal Paradise Shine (001 PARSH)

6002

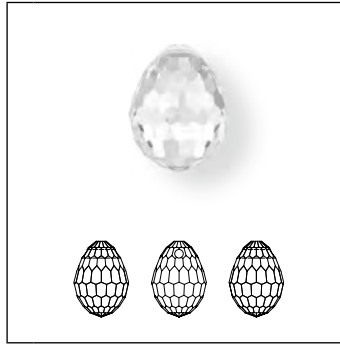

Size	10x7 mm	15x11.5 mm
Crystal		
Crystal (001)	■	■
Crystal Effects		
Transparent Effects		
Crystal AB (001 AB)	■	■

- Crystal**
- Crystal (001)
- Crystal Effects**
- Transparent Effects**
- Crystal AB (001 AB)

6007 Small Briolette Pendant



Size	7x4 mm	9x5 mm
Crystal		
Crystal (001)	■	■
Crystal Effects		
Transparent Effects		
Crystal AB (001 AB)	■	■
Crystal Golden Shadow (001 GSHA)	■	■

- Crystal**
- Crystal (001)
- Crystal Effects**
- Transparent Effects**
- Crystal AB (001 AB)
- Crystal Golden Shadow (001 GSHA)

PENDANTS

6010 Briolette Pendant



Size	11x5.5 mm	13x6.5 mm	17x8.5 mm	21x10.5 mm	50x21.5 mm
------	-----------	-----------	-----------	------------	------------

Crystal

Crystal (001)	■	■	■	■	■
---------------	---	---	---	---	---

Colors

Plain Colors

Amethyst (204)	■	■			
Aquamarine (202)	■	■	■		
Denim Blue (266)	■	■			
Erinite (360)	■	■	■		
Fuchsia (502)	■	■			
Graphite (253)	■	■			
Jet (280)	■	■			
Light Amethyst (212)	■	■			
Light Rose (223)	■	■			
Light Turquoise (263)	■	■			
Padparadscha (542)	■	■			
Rose Peach (262)	■	■			
Siam (208)	■	■			
Smoky Mauve (265)	■	■			
Tanzanite (539)	■	■	■		
Chrysolite Opal (294)	■	■			
Yellow Opal (231)	■	■			

Crystal Effects

Transparent Effects

Crystal AB (001 AB)	■	■	■	■	
Crystal Antique Pink (001 ANTP)	■	■			
Crystal Blue Shade (001 BLSH)	■	■			
Crystal Golden Shadow (001 GSHA)	■	■	■	■	
Crystal Lilac Shadow (001 LISH)	■	■			
Crystal Luminous Green (001 LUMG)	■	■			
Crystal Paradise Shine (001 PARSH)	■	■			
Crystal Silver Night (001 SINI)	■	■			
Crystal Silver Shade (001 SSHA)	■	■			

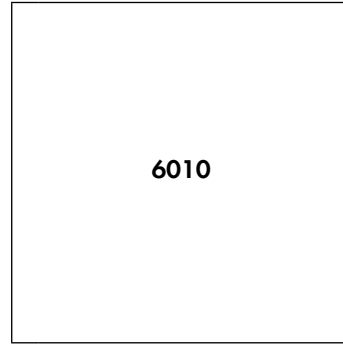

Size	11x5.5 mm	13x6.5 mm	17x8.5 mm	21x10.5 mm	50x21.5 mm
------	-----------	-----------	-----------	------------	------------

Metallic Effects

Crystal Iridescent Green (001 IRIG)	■	■			
Crystal Light Chrome (001 LTCH)	■	■			
Crystal Metallic Sunshine (001 METSH)	■	■			

Crystal Patina Effect

Crystal Black Patina (001 BLAPA)	■	■	■		
Crystal Gold Patina (001 GOLPA)	■	■	■		
Crystal Rose Patina (001 ROSPA)	■	■	■		
Crystal Silver Patina (001 SILPA)	■	■	■		
Crystal White Patina (001 WHIPA)	■	■	■		

PENDANTS

6012 Flat Briolette Pendant

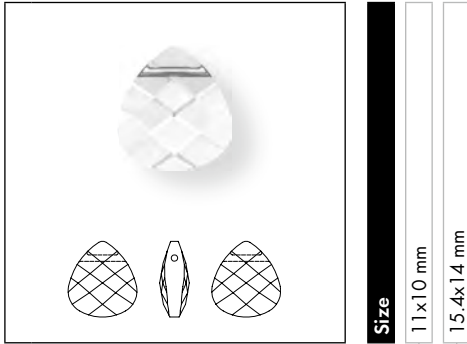

Size

11x10 mm

15.4x14 mm

Crystal

Crystal (001)

Colors

Plain Colors

Aquamarine (202)

Crystal Effects

Transparent Effects

Crystal AB (001 AB)

Crystal Golden Shadow (001 GSHA)

6015 Polygon Drop

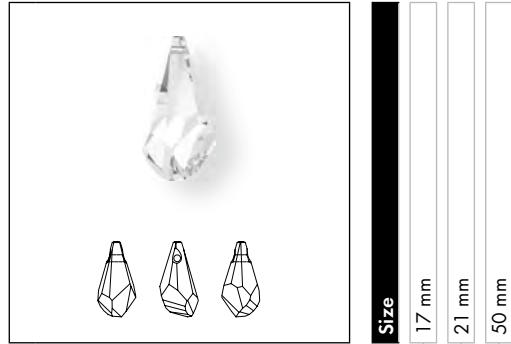

Size

17 mm

21 mm

50 mm

Crystal

Crystal (001)

Crystal Effects

Transparent Effects

Crystal AB (001 AB)

Crystal Golden Shadow (001 GSHA)

MAISON MARGIELA FOR SWAROVSKI

Crystalactite Pendants

Since 1988, Paris-based Maison Margiela has become famous for its collaborative team-led approach and its avant-garde transformation of classic designs. In July 2013, it presented the *Maison Margiela Crystalactite for Swarovski* at its Paris Haute Couture show. These were groundbreaking Crystal Fusion components inspired by natural stalactite forms and developed in creative partnership with Swarovski. Now Swarovski presents its interpretation of this innovative cut in pure crystal – the *Crystalactite Pendant*. Featuring a progressive aesthetic combining partly frosted facets with primeval, irregular

icicle shapes, the vision that originated in our wildest landscapes has now been perfected by one of the most sophisticated design houses. Together with an easy-to-apply hole at the top, the Grand and Petite Pendants offer myriad design possibilities for strong, contemporary designs, and for recreating haute-couture looks.

“Naturally and spontaneously, an imposing crystal emerges from its raw, stony origin, patiently growing into its iconic stalactite shape.”

6017/G Crystalactite Pendant grand partly frosted

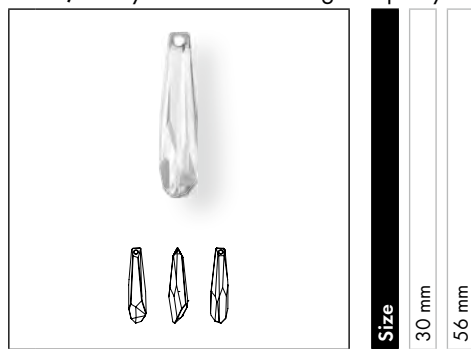

Size
30 mm
56 mm

Crystal		
Crystal (001)	<input type="checkbox"/>	<input type="checkbox"/>
Crystal Effects		
Transparent Effects		
Crystal AB V (001 AB V)	<input type="checkbox"/>	<input type="checkbox"/>
Crystal Antique Pink V (001 ANTP V)	<input type="checkbox"/>	<input type="checkbox"/>
Crystal Bermuda Blue P (001 BBL) ¹	<input type="checkbox"/>	<input type="checkbox"/>
Crystal Blue Shade V (001 BLSH V)	<input type="checkbox"/>	<input type="checkbox"/>
Crystal Bronze Shade V (001 BRSH V)	<input type="checkbox"/>	<input type="checkbox"/>
Crystal Golden Shadow V (001 GSHA V)	<input type="checkbox"/>	<input type="checkbox"/>
Crystal Silver Night (001 SINI)	<input type="checkbox"/>	<input type="checkbox"/>
Crystal Silver Shade V (001 SSHA V)	<input type="checkbox"/>	<input type="checkbox"/>
Crystal Vitrail Light P (001 VL) ¹	<input type="checkbox"/>	<input type="checkbox"/>
Crystal Vitrail Medium P (001 VM) ¹	<input type="checkbox"/>	<input type="checkbox"/>
Metallic Effects		
Crystal Comet Argent Light V P (001 CAL V) ¹	<input type="checkbox"/>	<input type="checkbox"/>

6019/G Crystalactite Pendant petite partly frosted

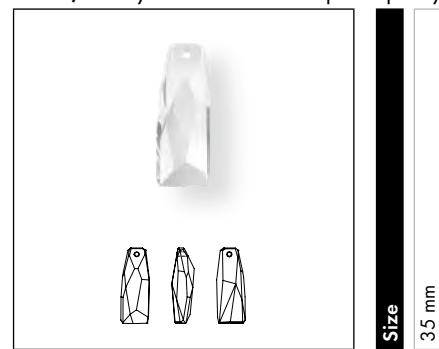

Size
35 mm

Crystal		
Crystal (001)	<input type="checkbox"/>	<input type="checkbox"/>
Crystal Effects		
Transparent Effects		
Crystal AB V (001 AB V)	<input type="checkbox"/>	<input type="checkbox"/>
Crystal Antique Pink V (001 ANTP V)	<input type="checkbox"/>	<input type="checkbox"/>
Crystal Bermuda Blue P (001 BBL) ¹	<input type="checkbox"/>	<input type="checkbox"/>
Crystal Blue Shade V (001 BLSH V)	<input type="checkbox"/>	<input type="checkbox"/>
Crystal Bronze Shade V (001 BRSH V)	<input type="checkbox"/>	<input type="checkbox"/>
Crystal Golden Shadow V (001 GSHA V)	<input type="checkbox"/>	<input type="checkbox"/>
Crystal Silver Night (001 SINI)	<input type="checkbox"/>	<input type="checkbox"/>
Crystal Silver Shade V (001 SSHA V)	<input type="checkbox"/>	<input type="checkbox"/>
Crystal Vitrail Light P (001 VL) ¹	<input type="checkbox"/>	<input type="checkbox"/>
Crystal Vitrail Medium P (001 VM) ¹	<input type="checkbox"/>	<input type="checkbox"/>
Metallic Effects		
Crystal Comet Argent Light V P (001 CAL V) ¹	<input type="checkbox"/>	<input type="checkbox"/>

¹ For details about the protective coating, please refer to the chapter 'Basic Information'.

PENDANTS

6020 Helix Pendant

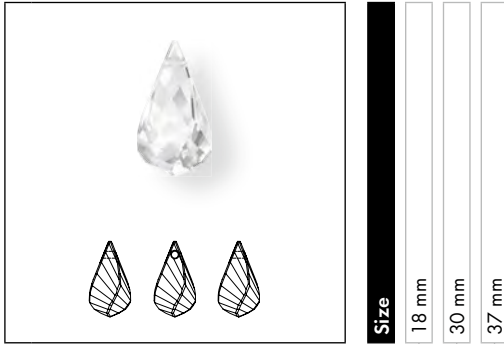

Size	18 mm	30 mm	37 mm
------	-------	-------	-------

Crystal			
Crystal (001)	■	■	■
Crystal Effects			
Transparent Effects			
Crystal AB (001 AB)	■	■	■
Crystal Golden Shadow (001 GSXA)	■	■	■
Crystal Red Magma (001 REDM)	■	■	■
Crystal Silver Shade (001 SSXA)	■	■	■

6022 XIRIUS Raindrop Pendant

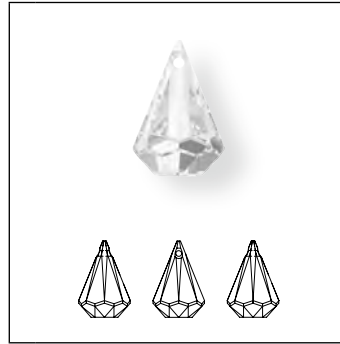

Size	14 mm	24 mm	33 mm
------	-------	-------	-------

Crystal			
Crystal (001)	■	■	■
Crystal Effects			
Transparent Effects			
Crystal AB (001 AB)	■	■	■
Crystal Blue Shade (001 BLSH)	■	■	■
Crystal Golden Shadow (001 GSXA)	■	■	■
Crystal Luminous Green (001 LUMG)	■	■	■
Crystal Red Magma (001 REDM)	■	■	■
Crystal Satin (001 SAT)	■	■	■

6028 XILION Oval Pendant

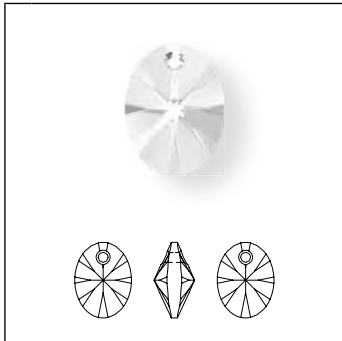

Size	8 mm	10 mm	12 mm	18 mm
------	------	-------	-------	-------

Crystal				
Crystal (001)	■	■	■	■
Colors				
Plain Colors				
Erinite (360)	■	■	■	■
Crystal Effects				
Transparent Effects				
Crystal AB (001 AB)	■	■	■	■
Crystal Golden Shadow (001 GSXA)	■	■	■	■
Crystal Silver Night (001 SINI)	■	■	■	■
Crystal Vitrail Light P (001 VL) ¹	■	■	■	■

6039 Disk Pendant

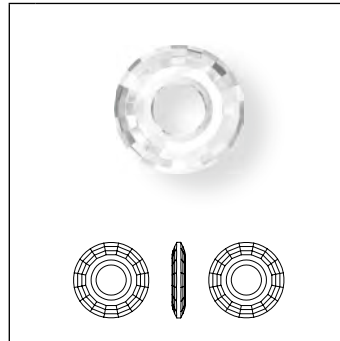

Size	25 mm	38 mm
------	-------	-------

Crystal		
Crystal (001)	■	■
Crystal Effects		
Transparent Effects		
Crystal Bermuda Blue P (001 BBL) ¹	■	■
Crystal Golden Shadow (001 GSXA)	■	■
Crystal Silver Night (001 SINI)	■	■
Metallic Effects		
Crystal Iridescent Green (001 IRIG)	■	■

¹ For details about the protective coating, please refer to the chapter 'Basic Information'.

PENDANTS

6040 Helios Pendant

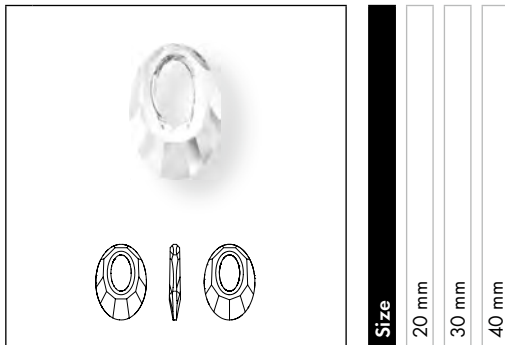

Crystal

Crystal (001)

Colors

Plain Color

Indicolite (379)

Crystal Effects

Transparent Effects

Crystal AB (001 AB)

Crystal Antique Pink (001 ANTP)

Crystal Blue Shade (001 BLSH)

Crystal Golden Shadow (001 GSHA)

Crystal Paradise Shine (001 PARSH)

Crystal Silver Night (001 SINI)

Crystal Vitrail Medium P (001 VM)¹

Metallic Effects

Crystal Comet Argent Light V P (001 CAL V)¹

Crystal Iridescent Green (001 IRIG)

Crystal Patina Effect

Crystal Black Patina (001 BLAPA)

Crystal Gold Patina (001 GOLPA)

Crystal Rose Patina (001 ROSPA)

Crystal Silver Patina (001 SILPA)

Crystal White Patina (001 WHIPA)

6041 Victory Pendant

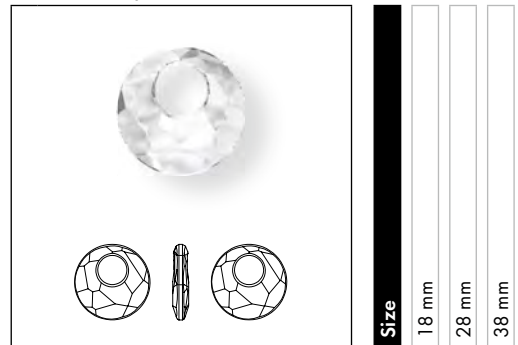

Crystal

Crystal (001)

Colors

Plain Colors

Aquamarine (202)

Jet (280)

Crystal Effects

Transparent Effects

Crystal AB (001 AB)

Crystal Antique Pink (001 ANTP)

Crystal Bronze Shade (001 BRSH)

Crystal Golden Shadow (001 GSHA)

Crystal Paradise Shine (001 PARSH)

Crystal Red Magma (001 REDM)

Crystal Satin (001 SAT)

6049



Crystal

Crystal (001)

¹ For details about the protective coating, please refer to the chapter 'Basic Information'.

PENDANTS

06 PENDANTS

6090 Baroque Pendant

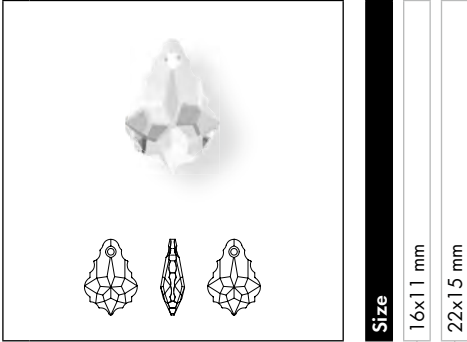

Size

16x11 mm

22x15 mm

Crystal

Crystal (001)

Colors

Plain Colors

Aquamarine (202)

Black Diamond (215)

Jet (280)

Ruby (501)

Crystal Effects

Transparent Effects

Crystal AB (001 AB)

Crystal Golden Shadow (001 GSHA)

Crystal Paradise Shine (001 PARSH)

6100

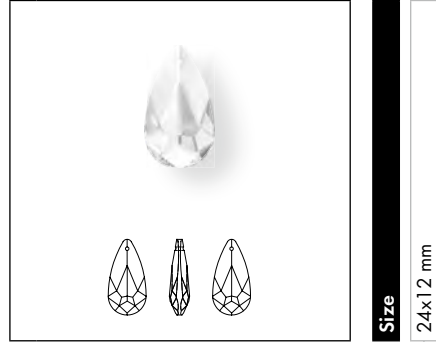

Size

24x12 mm

Crystal

Crystal (001)

Colors

Plain Colors

Fireopal (237)

Crystal Effects

Transparent Effects

Crystal AB (001 AB)

Crystal Bermuda Blue (001 BBL)

Crystal Vitrail Light (001 VL)

Crystal Vitrail Medium (001 VM)

PENDANTS

6106 Pear-shaped Pendant



Size	16 mm	22 mm	28 mm	38 mm	50 mm
------	-------	-------	-------	-------	-------

Crystal

Crystal (001)	■	■	■	■	■
---------------	---	---	---	---	---

Colors

Plain Colors

Aquamarine (202)	■	■			
Graphite (253)	■	■			
Jet (280)	■	■			
Light Rose (223)	■				
Peridot (214)	■	■			
Ruby (501)	■	■			
Smoky Mauve (265)	■	■			
Tanzanite (539)	■	■			

Crystal Effects

Transparent Effects

Crystal AB (001 AB)	■	■	■		
Crystal Antique Pink (001 ANTP)	■	■	■		
Crystal Astral Pink (001 API)	■	■			
Crystal Blue Shade (001 BLSH)	■	■	■		
Crystal Golden Shadow (001 GSHA)	■	■	■	■	
Crystal Luminous Green (001 LUMG)	■	■			
Crystal Silver Night (001 SINI)	■	■	■		
Crystal Silver Shade (001 SSHA)	■	■	■		

Metallic Effects

Crystal Iridescent Green (001 IRIG)	■	■			
Crystal Light Chrome (001 LTCH)	■	■			
Crystal Paradise Shine (001 PARSH)	■	■	■		
Crystal Rainbow Dark (001 RABDK)	■	■			
Crystal Scarabaeus Green (001 SCGR)***	■	■			

Crystal Patina Effect

Crystal Black Patina (001 BLAPA)	■	■	■		
Crystal Gold Patina (001 GOLPA)	■	■	■		
Crystal Rose Patina (001 ROSPA)	■	■	■		
Crystal Silver Patina (001 SILPA)	■	■	■		
Crystal White Patina (001 WHIPA)	■	■	■		

6110 Navette Pendant

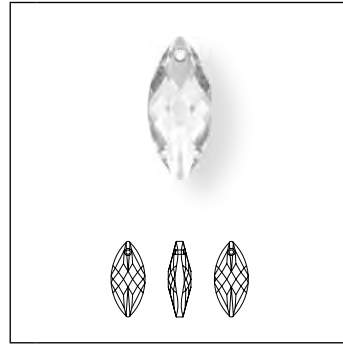

Size	30x14 mm	40x18 mm
------	----------	----------

Crystal

Crystal (001)	■	■
---------------	---	---

Crystal Effects

Transparent Effects

Crystal Golden Shadow (001 GSHA)	■	■
Crystal Silver Shade (001 SSHA)	■	■

6128 XILION Mini Pear Pendant

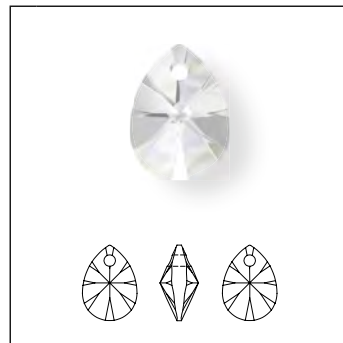

Size	8 mm	10 mm	12 mm
------	------	-------	-------

Crystal

Crystal (001)	■	■	■
---------------	---	---	---

Colors

Plain Colors

Denim Blue (266)	■	■	■
Jet (280)	■	■	■

Crystal Effects

Transparent Effects

Crystal AB (001 AB)	■	■	■
Crystal Golden Shadow (001 GSHA)	■	■	■
Crystal Paradise Shine (001 PARSH)	■	■	■

Metallic Effects

Crystal Metallic Sunshine (001 METSH)	■	■	■
Crystal Rose Gold (001 ROGL)	■	■	■

*** designed by Jean Paul Gaultier

PENDANTS

6150 Pegasus Pendant

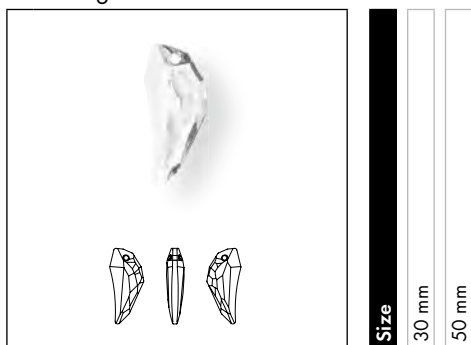

Size
30 mm
50 mm

- Crystal**
- Crystal (001)
- Colors**
- Plain Colors**
- Jet (280)
- Crystal Effects**
- Transparent Effects**
- Crystal Golden Shadow (001 GSHA)
- Crystal Satin (001 SAT)

6210

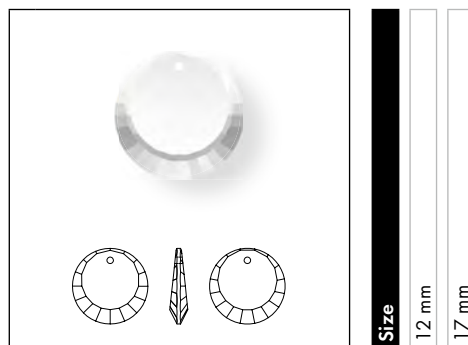

Size
12 mm
17 mm

- Crystal**
- Crystal (001)
- Crystal Effects**
- Transparent Effects**
- Crystal AB (001 AB)

6215

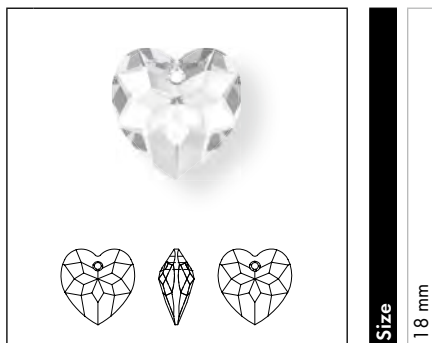

Size
18 mm

- Crystal**
- Crystal (001)
- Crystal Effects**
- Transparent Effects**
- Crystal AB (001 AB)
- Crystal Bermuda Blue P (001 BBL) ¹
- Crystal Red Magma (001 REDM)

6225

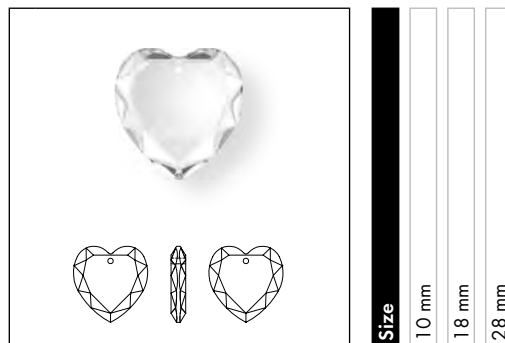

Size
10 mm
18 mm
28 mm

- Crystal**
- Crystal (001)

¹ For details about the protective coating, please refer to the chapter 'Basic Information'.

PENDANTS

6228 XILION Heart Pendant

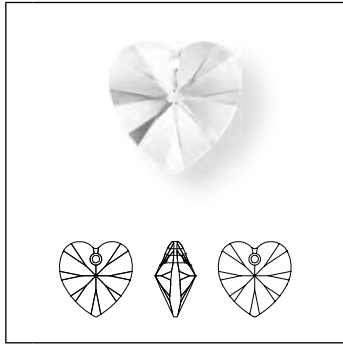

Size	10.3x10 mm	14.4x14 mm	18x17.5 mm	28 mm	40 mm
------	------------	------------	------------	-------	-------

Crystal

Crystal (001)

Colors

Plain Colors

- Amethyst (204)
- Aquamarine (202)
- Blue Zircon (229)
- Blush Rose (257)
- Denim Blue (266)
- Emerald (205)
- Fuchsia (502)
- Graphite (253)
- Jet (280)
- Light Rose (223)
- Light Siam (227)
- Light Topaz (226)
- Light Turquoise (263)
- Padparadscha (542)
- Peridot (214)
- Rose (209)
- Sapphire (206)
- Siam (208)
- Smoky Mauve (265)
- Tanzanite (539)
- Violet (371)

Opal Colors

Yellow Opal (231)

Crystal Effects

Transparent Effects

- Crystal AB (001 AB)
- Crystal Antique Pink (001 ANTP)
- Crystal Bermuda Blue (001 BBL)
- Crystal Bermuda Blue P (001 BBL)¹
- Crystal Golden Shadow (001 GSHA)
- Crystal Heliotrope (001 HEL)
- Crystal Moonlight (001 MOL)
- Crystal Paradise Shine (001 PARSH)
- Crystal Silver Night (001 SINI)
- Crystal Vitrail Light (001 VL)
- Crystal Vitrail Medium (001 VM)

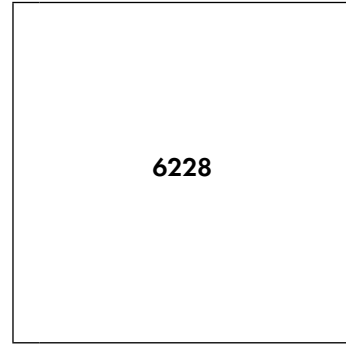

Size	10.3x10 mm	14.4x14 mm	18x17.5 mm	28 mm	40 mm
------	------------	------------	------------	-------	-------

Metallic Effects

- Crystal Light Chrome (001 LTCH)
- Crystal Metallic Sunshine (001 METSH)
- Crystal Rainbow Dark (001 RABDK)
- Crystal Scarabaeus Green (001 SCGR)^{***}

Crystal Patina

- Crystal Black Patina (001 BLAPA)
- Crystal Gold Patina (001 GOLPA)
- Crystal Rose Patina (001 ROSPA)
- Crystal Silver Patina (001 SILPA)
- Crystal White Patina (001 WHIPA)

Color Effects

Transparent Effects

- Aquamarine AB (202 AB)
- Blue Zircon AB (229 AB)
- Fuchsia AB (502 AB)
- Light Rose AB (223 AB)
- Light Siam AB (227 AB)
- Light Topaz AB (226 AB)
- Peridot AB (214 AB)
- Rose AB (209 AB)
- Sapphire AB (206 AB)
- Siam AB (208 AB)
- Violet AB (371 AB)

^{***} designed by Jean Paul Gaultier

¹ For details about the protective coating, please refer to the chapter 'Basic Information'.

PENDANTS

6240 Wild Heart Pendant



Size	12 mm	17 mm	27 mm	37 mm
------	-------	-------	-------	-------

Crystal

Crystal (001)

Colors

Plain Colors

Aquamarine (202)

Rosaline (508)

Tanzanite (539)

Crystal Effects

Transparent Effects

Crystal AB (001 AB)

Crystal Antique Pink (001 ANTP)

Crystal Golden Shadow (001 GSHA)

Crystal Red Magma (001 REDM)

Crystal Vitrail Medium P (001 VM)¹

Metallic Effects

Crystal Comet Argent Light V P (001 CAL V)¹

Crystal Iridescent Green (001 IRIG)

Crystal Patina

Crystal Black Patina (001 BLAPA)

Crystal Gold Patina (001 GOLPA)

Crystal Rose Patina (001 ROSPA)

Crystal Silver Patina (001 SILPA)

Crystal White Patina (001 WHIPA)

Crystal (001)	■	■	■	■
Aquamarine (202)	■	■	■	■
Rosaline (508)	■	■	■	
Tanzanite (539)	■	■	■	
Crystal AB (001 AB)	■	■	■	■
Crystal Antique Pink (001 ANTP)	■	■	■	
Crystal Golden Shadow (001 GSHA)	■	■	■	■
Crystal Red Magma (001 REDM)	■	■	■	
Crystal Vitrail Medium P (001 VM) ¹		■	■	
Crystal Comet Argent Light V P (001 CAL V) ¹		■	■	
Crystal Iridescent Green (001 IRIG)	■	■	■	
Crystal Black Patina (001 BLAPA)		■	■	■
Crystal Gold Patina (001 GOLPA)		■	■	■
Crystal Rose Patina (001 ROSPA)		■	■	■
Crystal Silver Patina (001 SILPA)		■	■	■
Crystal White Patina (001 WHIPA)		■	■	■

¹ For details about the protective coating, please refer to the chapter 'Basic Information'.

“LOVE STORY OF THE HEART” BY MANISH ARORA

Since the beginning of his international career, the award winning, Delhi-based designer Manish Arora has worked creatively with Swarovski. In 2009, he created a memorable collection of crystalline Transfers. One year later, India’s best loved and most prolific design talent renewed his partnership with Swarovski and created a special collection of heart-shaped crystal pendants, which were launched in February 2011. Each individual piece is an expression of love’s different emotional state and is named accordingly.

The partnership with Manish Arora is symbolic of how Swarovski engages in mutually rewarding creative partnerships with the world’s best and brightest design spirits.

“The heart shape is very close to me because it is the universal symbol of love. I wanted to bring this symbol to life by creating a collection of crystal pendants and I hope people will wear them as a personal expression of the beauty and purity of this emotion,” Manish Arora

6261 Devoted 2 U Heart

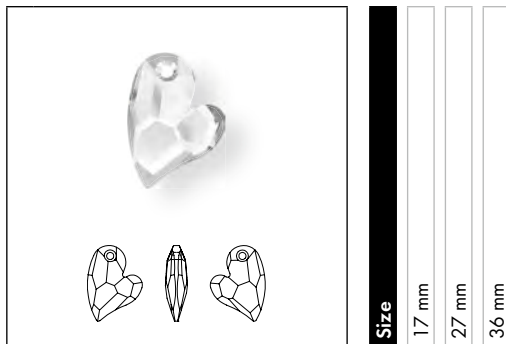

Size
17 mm
27 mm
36 mm

Crystal	17 mm	27 mm	36 mm
Crystal (001)	■	■	■
Colors			
Plain Colors			
Amethyst (204)	■		
Aquamarine (202)	■		
Rosaline (508)	■		
Crystal Effects			
Transparent Effects			
Crystal AB (001 AB)	■	■	■
Crystal Antique Pink (001 ANTP)	■	■	■
Crystal Astral Pink (001 API)	■	■	
Crystal Bermuda Blue P (001 BBL) ¹			■
Crystal Golden Shadow (001 GSHA)	■	■	
Crystal Red Magma (001 REDM)	■	■	
Crystal Satin (001 SAT)	■		
Crystal Vitrail Medium P (001 VM) ¹	■	■	
Metallic Effects			
Crystal Comet Argent Light V P (001 CALV) ¹	■	■	

6262 Miss U Heart

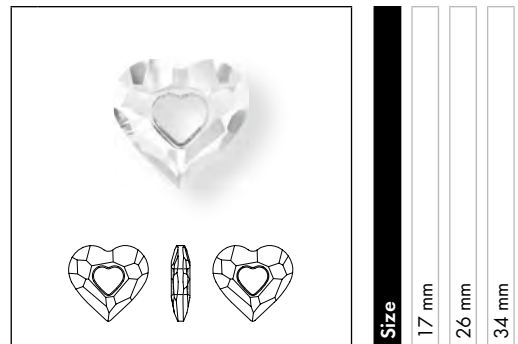

Size
17 mm
26 mm
34 mm

Crystal	17 mm	26 mm	34 mm
Crystal (001)	■	■	■
Crystal Effects			
Transparent Effects			
Crystal AB (001 AB)	■	■	■
Crystal Antique Pink (001 ANTP)	■	■	■
Crystal Golden Shadow (001 GSHA)	■	■	
Crystal Satin (001 SAT)	■	■	

¹ For details about the protective coating, please refer to the chapter ‘Basic Information’.

6264 Truly in Love Heart

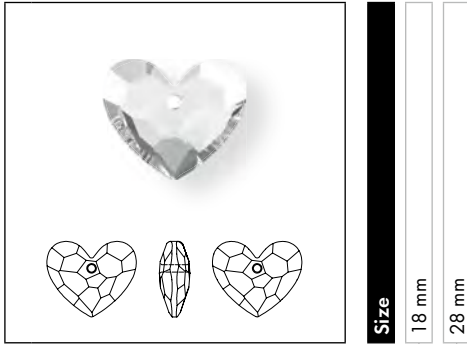

Size
18 mm
28 mm

Crystal	18 mm	28 mm
Crystal (001)	■	■
Crystal Effects		
Transparent Effects		
Crystal AB (001 AB)	■	■
Crystal Antique Pink (001 ANTP)	■	■
Crystal Bermuda Blue P (001 BBL) ¹	■	■
Crystal Golden Shadow (001 GSHA)	■	■
Crystal Red Magma (001 REDM)	■	■
Crystal Satin (001 SAT)	■	■

06 PENDANTS

DESIGNER EDITIONS - DISTINCT PACKAGING

This Designer Edition will be labelled with the "Designer Edition" imprint directly on the packaging.

¹ For details about the protective coating, please refer to the chapter 'Basic Information'.

PENDANTS

6320 Rhombus Pendant

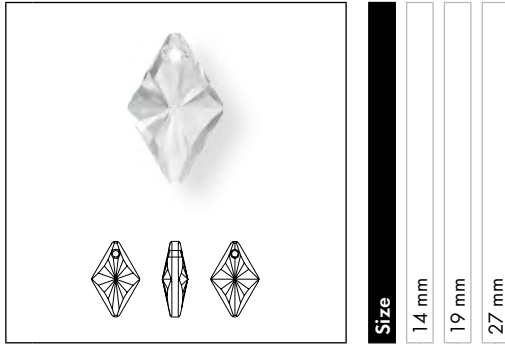

Size
14 mm
19 mm
27 mm

Crystal

Crystal (001)

Crystal Effects

Transparent Effects

Crystal AB (001 AB)

Crystal Golden Shadow (001 GSHA)

6401 Octagon Pendant

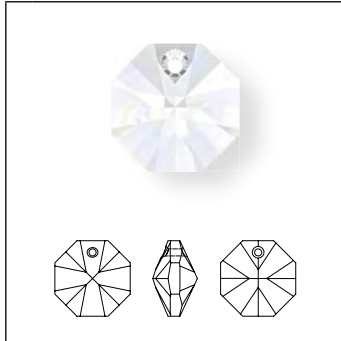

Size
8 mm
12 mm

Crystal

Crystal (001)

Colors

Plain Colors

Aquamarine (202)

Light Rose (223)

Tanzanite (539)

Crystal Effects

Transparent Effects

Crystal AB (001 AB)

Crystal Golden Shadow (001 GSHA)

Crystal Silver Shade (001 SSHA)

6328 XILION Bi-Cone Pendant

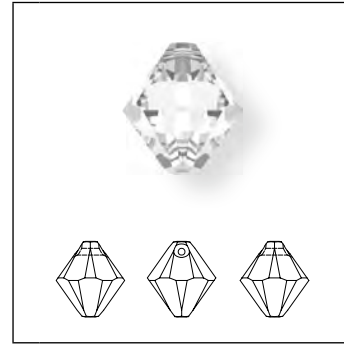

Size
6 mm
8 mm

Crystal

Crystal (001)

Colors

Plain Colors

Aquamarine (202)

Graphite (253)

Light Rose (223)

Provence Lavender (283)

Rose (209)

Violet (371)

Crystal Effects

Transparent Effects

Crystal AB (001 AB)

Crystal Golden Shadow (001 GSHA)

Crystal Paradise Shine (001 PARSH)

Metallic Effects

Crystal Metallic Sunshine (001 METSH)

Crystal Rose Gold 2x (001 ROGL2X)

PENDANTS

6428 XILION Pendant

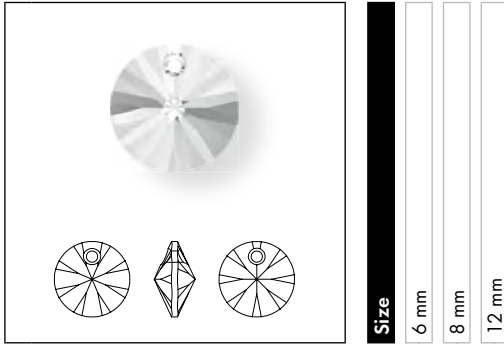

Size	6 mm	8 mm	12 mm
------	------	------	-------

Crystal			
Crystal (001)	■	■	■
Colors			
Plain Colors			
Amethyst (204)	■	■	
Aquamarine (202)	■	■	
Denim Blue (266)	■	■	
Graphite (253)	■	■	
Jet (280)	■	■	
Light Siam (227)	■	■	
Light Turquoise (263)	■	■	
Rose (209)	■	■	
Rose Peach (262)	■	■	
Siam (208)	■	■	
Smoky Mauve (265)	■	■	
Violet (371)	■	■	
Opal Colors			
Yellow Opal (231)	■	■	
Crystal Effects			
Transparent Effects			
Crystal AB (001 AB)	■	■	■
Crystal Antique Pink (001 ANTP)	■	■	■
Crystal Astral Pink (001 API)			■
Crystal Blue Shade (001 BLSH)	■	■	
Crystal Bronze Shade (001 BRSH)	■	■	
Crystal Golden Shadow (001 GSHA)	■	■	■
Crystal Luminous Green (001 LUMG)	■	■	■
Crystal Paradise Shine (001 PARSH)	■	■	■
Crystal Silver Night (001 SINI)	■	■	
Crystal Silver Shade (001 SSHA)	■	■	■
Metallic Effects			
Crystal Light Chrome (001 LTCH)	■	■	
Crystal Metallic Sunshine (001 METSH)	■	■	
Crystal Scarabaeus Green (001 SCGR)***	■	■	■
Crystal Patina Effect			
Crystal Black Patina (001 BLAPA)	■	■	■
Crystal Gold Patina (001 GOLPA)	■	■	■
Crystal Rose Patina (001 ROSPA)	■	■	■
Crystal Silver Patina (001 SILPA)	■	■	■
Crystal White Patina (001 WHIPA)	■	■	■

6460 Column Pendant

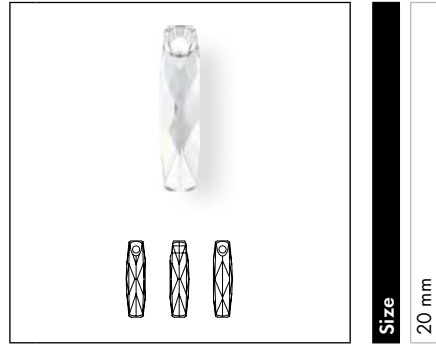

Size	20 mm
------	-------

Crystal	
Crystal (001)	■
Crystal Effects	
Transparent Effects	
Crystal AB (001 AB)	■
Crystal Golden Shadow (001 GSHA)	■
Crystal Silver Shade (001 SSHA)	■

*** designed by Jean Paul Gaultier

PENDANTS

6465 Queen Baguette Pendant

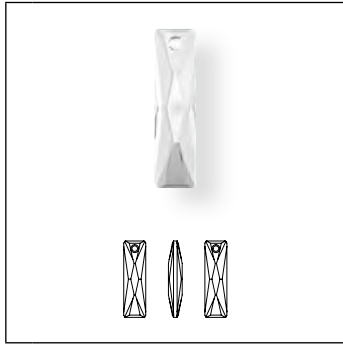

Size	13.5x6 mm	25x7 mm	38x10 mm
-------------	-----------	---------	----------

Crystal			
Crystal (001)	■	■	■
Colors			
Plain Colors			
Aquamarine (202)	■	■	■
Jet (280)	■	■	■
Light Amethyst (212)	■	■	■
Montana (207)	■	■	■
Peridot (214)	■	■	■
Crystal Effects			
Transparent Effects			
Crystal AB (001 AB)	■	■	■
Crystal Bermuda Blue P (001 BBL) ¹	■	■	■
Crystal Golden Shadow (001 GSHA)	■	■	■
Crystal Lilac Shadow (001 LISH)	■	■	■
Crystal Luminous Green (001 LUMG)	■	■	■
Crystal Paradise Shine (001 PARSH)	■	■	■
Crystal Red Magma (001 REDM)	■	■	■
Crystal Silver Night (001 SINI)	■	■	■
Crystal Vitrail Light P (001 VL) ¹	■	■	■
Crystal Volcano P (001 VOL) ¹	■	■	■
Metallic Effects			
Crystal CAL V P (001 CAL V) ¹	■	■	■
Crystal Metallic Sunshine (001 METSH)	■	■	■

6470 Ellipse Pendant

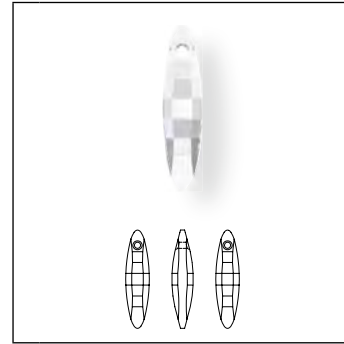

Size	32 mm	40 mm
-------------	-------	-------

Crystal		
Crystal (001)	■	■
Colors		
Plain Colors		
Aquamarine (202)	■	■
Olivine (228)	■	■
Crystal Effects		
Transparent Effects		
Crystal AB (001 AB)	■	■
Crystal Golden Shadow (001 GSHA)	■	■

¹ For details about the protective coating, please refer to the chapter 'Basic Information'.

PENDANTS

6480 Spike Pendant

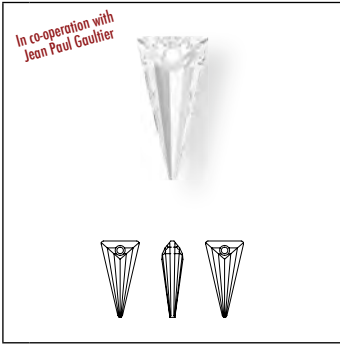

Size	18 mm	28 mm	39 mm
------	-------	-------	-------

Crystal

Crystal (001)

Colors

Plain Colors

Jet (280)

Crystal Effects

Transparent Effects

Crystal AB (001 AB)

Crystal Antique Pink (001 ANTP)

Crystal Astral Pink (001 API)

Crystal Bermuda Blue P (001 BBL)¹

Crystal Blue Shade (001 BLSH)

Crystal Bronze Shade (001 BRSH)

Crystal Golden Shadow (001 GSHA)

Crystal Luminous Green (001 LUMG)

Crystal Red Magma (001 REDM)

Crystal Silver Night (001 SINI)

Crystal Silver Shade (001 SSHA)

Crystal Vitrail Medium P (001 VM)¹

Metallic Effects

Crystal Rainbow Dark (001 RABDK)

Crystal Patina Effect

Crystal Black Patina (001 BLAPA)

Crystal Gold Patina (001 GOLPA)

Crystal Rose Patina (001 ROSPA)

Crystal Silver Patina (001 SILPA)

Crystal White Patina (001 WHIPA)

06 PENDANTS

¹ For details about the protective coating, please refer to the chapter 'Basic Information'.

PENDANTS

HALF HOLE PENDANTS

6530 Pure Drop Pendant (half hole)



Size	12 mm	20 mm	30 mm
------	-------	-------	-------

Crystal

Crystal (001)	■	■	■
---------------	---	---	---

Colors

Plain Colors

Amethyst (204)	■	■	■
Aquamarine (202)	■	■	■
Blush Rose (257)	■	■	■
Emerald (205)	■	■	■
Jet (280)	■	■	■
Ruby (501)	■	■	■
Siam (208)	■	■	■
Smoky Quartz F (225)	■	■	■

Opal Colors

Chrysolite Opal (294)	■	■	■
-----------------------	---	---	---

Crystal Effects

Transparent Effects

Crystal AB (001 AB)	■	■	■
Crystal Golden Shadow (001 GSHA)	■	■	■
Crystal Lilac Shadow (001 LISH)	■	■	■
Crystal Paradise Shine (001 PARSH)	■	■	■
Crystal Silver Shade (001 SSHA)	■	■	■

Metallic Effects

Crystal Metallic Sunshine (001 METSH)	■	■	■
---------------------------------------	---	---	---

6531¹ Pure Drop Pendant (half hole) with classic cap



Size & color of plating

15.5 mm Gold	15.5 mm Rose Gold	15.5 mm Rhodium	15.5 mm Gun Metal	24 mm Gold	24 mm Rose Gold	24 mm Rhodium	24 mm Gun Metal	34 mm Gold	34 mm Rose Gold	34 mm Rhodium	34 mm Gun Metal
--------------	-------------------	-----------------	-------------------	------------	-----------------	---------------	-----------------	------------	-----------------	---------------	-----------------

Crystal

Crystal (001)

Colors

Plain Colors

Amethyst (204)

Aquamarine (202)

Blush Rose (257)

Emerald (205)

Jet (280)

Ruby (501)

Siam (208)

Smoky Quartz F (225)

Opal Colors

Chrysolite Opal (294)

Crystal Effects

Transparent Effects

Crystal AB (001 AB)

Crystal Golden Shadow (001 GSHA)

Crystal Lilac Shadow (001 LISH)

Crystal Paradise Shine (001 PARSH)

Crystal Silver Shade (001 SSHA)

Metallic Effects

Crystal Metallic Sunshine (001 METSH)

Crystal (001)	15.5 mm Gold	15.5 mm Rose Gold	15.5 mm Rhodium	15.5 mm Gun Metal	24 mm Gold	24 mm Rose Gold	24 mm Rhodium	24 mm Gun Metal	34 mm Gold	34 mm Rose Gold	34 mm Rhodium	34 mm Gun Metal
Amethyst (204)	■	■	■	■	■	■	■	■	■	■	■	■
Aquamarine (202)	■	■	■	■	■	■	■	■	■	■	■	■
Blush Rose (257)	■	■	■	■	■	■	■	■	■	■	■	■
Emerald (205)	■	■	■	■	■	■	■	■	■	■	■	■
Jet (280)	■	■	■	■	■	■	■	■	■	■	■	■
Ruby (501)	■	■	■	■	■	■	■	■	■	■	■	■
Siam (208)	■	■	■	■								
Smoky Quartz F (225)	■	■	■	■	■	■	■	■	■	■	■	■
Chrysolite Opal (294)	■	■	■	■								
Crystal AB (001 AB)	■	■	■	■	■	■	■	■	■	■	■	■
Crystal Golden Shadow (001 GSHA)	■	■	■	■	■	■	■	■	■	■	■	■
Crystal Lilac Shadow (001 LISH)	■	■	■	■	■	■	■	■	■	■	■	■
Crystal Paradise Shine (001 PARSH)	■	■	■	■	■	■	■	■	■	■	■	■
Crystal Silver Shade (001 SSHA)	■	■	■	■	■	■	■	■	■	■	■	■
Crystal Metallic Sunshine (001 METSH)	■	■	■	■	■	■	■	■	■	■	■	■

06 PENDANTS

¹ Please note that delivery for these items can take up to three weeks

6532¹ Pure Drop Pendant (half hole) with trumpet cap



	21 mm Gold	21 mm Rose Gold	21 mm Rhodium	21 mm Gun Metal	31.5 mm Gold	31.5 mm Rose Gold	31.5 mm Rhodium	31.5 mm Gun Metal	44 mm Gold	44 mm Rose Gold	44 mm Rhodium	44 mm Gun Metal
Crystal												
Crystal (001)	■	■	■	■	■	■	■	■	■	■	■	■
Colors												
Plain Colors												
Amethyst (204)	■	■	■	■	■	■	■	■	■	■	■	■
Aquamarine (202)	■	■	■	■	■	■	■	■	■	■	■	■
Blush Rose (257)	■	■	■	■	■	■	■	■	■	■	■	■
Emerald (205)	■	■	■	■	■	■	■	■	■	■	■	■
Jet (280)	■	■	■	■	■	■	■	■	■	■	■	■
Ruby (501)	■	■	■	■	■	■	■	■	■	■	■	■
Siam (208)	■	■	■	■								
Smoky Quartz F (225)	■	■	■	■	■	■	■	■	■	■	■	■
Opal Colors												
Chrysolite Opal (294)	■	■	■	■								
Crystal Effects												
Transparent Effects												
Crystal AB (001 AB)	■	■	■	■	■	■	■	■	■	■	■	■
Crystal Golden Shadow (001 GSHA)	■	■	■	■	■	■	■	■	■	■	■	■
Crystal Lilac Shadow (001 LISH)	■	■	■	■	■	■	■	■	■	■	■	■
Crystal Paradise Shine (001 PARSH)	■	■	■	■	■	■	■	■	■	■	■	■
Crystal Silver Shade (001 SSHA)	■	■	■	■	■	■	■	■	■	■	■	■
Metallic Effects												
Crystal Metallic Sunshine (001 METSH)	■	■	■	■	■	■	■	■	■	■	■	■

¹ Please note that delivery for these items can take up to three weeks

PENDANTS

HALF HOLE PENDANTS

6533 Raindrop Pendant



Size & color of plating

17.5 mm Gold
 17.5 mm Rhodium
 23 mm Gold
 23 mm Rhodium
 33 mm Gold
 33 mm Rhodium

Crystal

Crystal (001)

Colors

Plain Colors

Blush Rose (257)

Jet (280)

Tanzanite (539)

Crystal Effects

Transparent Effects

Crystal AB (001 AB)

Crystal Golden Shadow (001 GSHA)

Crystal Silver Night (001 SINI)

06 PENDANTS

Crystal (001)	■	■	■	■	■	■
Blush Rose (257)	■	■	■	■	■	■
Jet (280)	■	■	■	■	■	■
Tanzanite (539)	■	■	■	■	■	■
Crystal AB (001 AB)	■	■	■	■	■	■
Crystal Golden Shadow (001 GSHA)	■	■	■	■	■	■
Crystal Silver Night (001 SINI)	■	■	■	■	■	■

PENDANTS

HALF HOLE PENDANTS

6540 Twisted Drop Pendant (half hole)



Crystal	12 mm	20 mm	30 mm
Crystal (001)	■	■	■
Colors			
Plain Colors			
Amethyst (204)	■	■	■
Aquamarine (202)	■	■	■
Blush Rose (257)	■	■	■
Emerald (205)	■	■	■
Jet (280)	■	■	■
Ruby (501)	■	■	■
Siam (208)	■	■	■
Smoky Quartz F (225)	■	■	■
Opal Colors			
Chrysolite Opal (294)	■		
Crystal Effects			
Transparent Effects			
Crystal AB (001 AB)	■	■	■
Crystal Golden Shadow (001 GSHA)	■	■	■
Crystal Lilac Shadow (001 LISH)	■	■	■
Crystal Paradise Shine (001 PARSH)	■	■	■
Crystal Silver Shade (001 SSHA)	■	■	■
Metallic Effects			
Crystal Metallic Sunshine (001 METSH)	■	■	■

6541¹ Twisted Drop Pendant (half hole) with bail



Crystal	14.5 mm Gold	14.5 mm Rose Gold	14.5 mm Rhodium	14.5 mm Gun Metal
Crystal (001)	■	■	■	■
Colors				
Plain Colors				
Amethyst (204)	■	■	■	■
Aquamarine (202)	■	■	■	■
Blush Rose (257)	■	■	■	■
Emerald (205)	■	■	■	■
Jet (280)	■	■	■	■
Ruby (501)	■	■	■	■
Siam (208)	■	■	■	■
Smoky Quartz (225)	■	■	■	■
Opal Colors				
Chrysolite Opal (294)	■	■	■	■
Crystal Effects				
Transparent Effects				
Crystal AB (001 AB)	■	■	■	■
Crystal Golden Shadow (001 GSHA)	■	■	■	■
Crystal Lilac Shadow (001 LISH)	■	■	■	■
Crystal Paradise Shine (001 PARSH)	■	■	■	■
Crystal Silver Shade (001 SSHA)	■	■	■	■
Metallic Effects				
Crystal Metallic Sunshine (001 METSH)	■	■	■	■

¹ Please note that delivery for these items can take up to three weeks

PENDANTS

65M001 Trumpet Cap

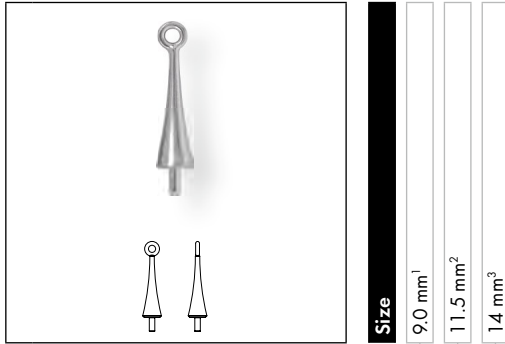

Size

9.0 mm¹

11.5 mm²

14 mm³

Colors of plating

Gold	■	■	■
Rose Gold	■	■	■
Rhodium	■	■	■
Gun Metal	■	■	■
Brass Unplated	■	■	■

HALF HOLE PENDANTS

65M002 Classic Cap

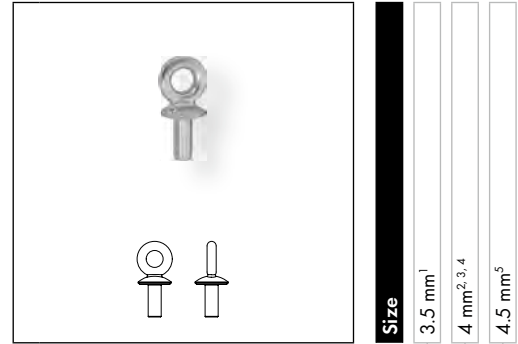

Size

3.5 mm¹

4 mm^{2, 3, 4}

4.5 mm⁵

Colors of plating

Gold	■	■	■
Rose Gold	■	■	■
Rhodium	■	■	■
Gun Metal	■	■	■
Brass Unplated	■	■	■

65M003 Bail

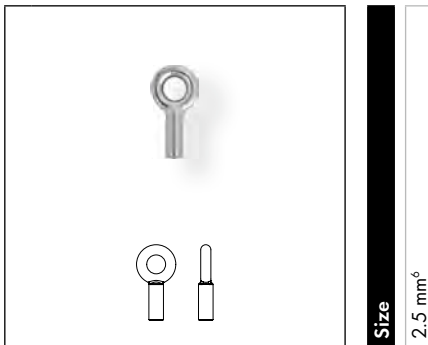

Size

2.5 mm⁶

Colors of plating

Gold	■
Rose Gold	■
Rhodium	■
Gun Metal	■
Brass Unplated	■

¹ fits 6530 12 mm

² fits 6530 20 mm

³ fits 6530 30 mm

⁴ fits 6540 20 mm

⁵ fits 6540 30 mm

⁶ fits 6540 12 mm

PENDANTS

6621 Twist Pendant

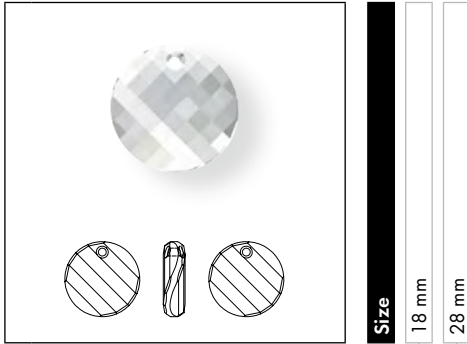

Size
18 mm
28 mm

- Crystal**
- Crystal (001)
- Crystal Effects**
- Transparent Effects**
- Crystal Bermuda Blue P (001 BBL) ¹
- Crystal Golden Shadow (001 GSHA)
- Crystal Moonlight (001 MOL)
- Crystal Silver Night (001 SINI)
- Crystal Vitrail Medium P (001 VM) ¹
- Metallic Effects**
- Crystal Comet Argent Light V P (001 CAL V) ¹

6628 XILION Triangle Pendant

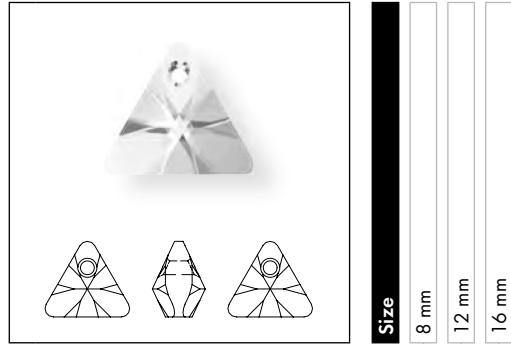

Size
8 mm
12 mm
16 mm

- Crystal**
- Crystal (001)
- Crystal Effects**
- Transparent Effects**
- Crystal AB (001 AB)
- Crystal Bermuda Blue P (001 BBL) ¹
- Crystal Golden Shadow (001 GSHA)
- Crystal Paradise Shine (001 PARSH)
- Crystal Silver Night (001 SINI)
- Crystal Vitrail Light P (001 VL) ¹

6650 Cubist Pendant



Size
22 mm

- Crystal**
- Crystal (001)
- Colors**
- Plain Colors**
- Light Amethyst (212)
- Light Sapphire (211)
- Crystal Effects**
- Transparent Effects**
- Crystal Golden Shadow (001 GSHA)
- Crystal Moonlight (001 MOL)

6656 Galactic Vertical Pendant

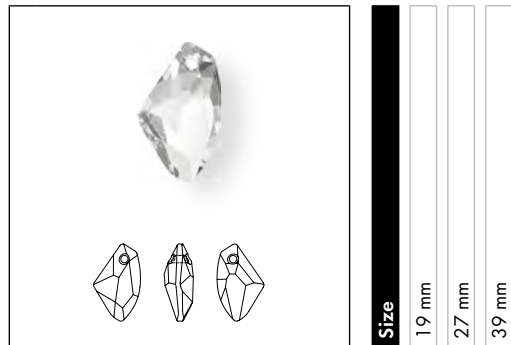

Size
19 mm
27 mm
39 mm

- Crystal**
- Crystal (001)
- Colors**
- Plain Colors**
- Aquamarine (202)
- Light Rose (223)
- Peridot (214)
- Tanzanite (539)
- Crystal Effects**
- Transparent Effects**
- Crystal Bermuda Blue P (001 BBL) ¹
- Crystal Golden Shadow (001 GSHA)
- Crystal Moonlight (001 MOL)
- Crystal Silver Shade (001 SSHA)

¹ For details about the protective coating, please refer to the chapter 'Basic Information'.

PENDANTS

6670 De-Art Pendant

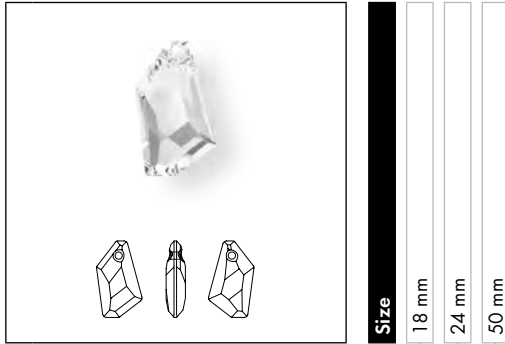

Crystal	
<input type="checkbox"/> Crystal (001)	<input type="checkbox"/>
Colors	
Plain Colors	
<input type="checkbox"/> Aquamarine (202)	<input type="checkbox"/>
Crystal Effects	
Transparent Effects	
<input type="checkbox"/> Crystal AB (001 AB)	<input type="checkbox"/>
<input type="checkbox"/> Crystal Bermuda Blue P (001 BBL) ¹	<input type="checkbox"/>
<input type="checkbox"/> Crystal Golden Shadow (001 GSHA)	<input type="checkbox"/>
<input type="checkbox"/> Crystal Silver Night (001 SINI)	<input type="checkbox"/>

6673 Meteor Pendant

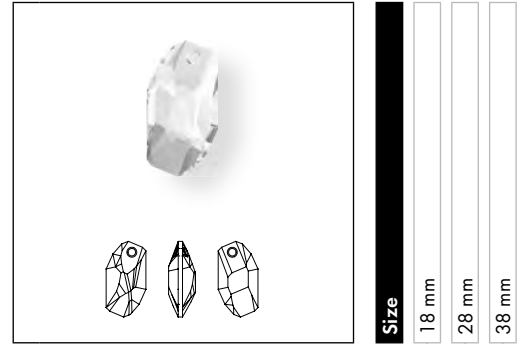

Crystal	
<input type="checkbox"/> Crystal (001)	<input type="checkbox"/>
Colors	
Plain Colors	
<input type="checkbox"/> Light Turquoise (263)	<input type="checkbox"/>
Crystal Effects	
Transparent Effects	
<input type="checkbox"/> Crystal AB (001 AB)	<input type="checkbox"/>
<input type="checkbox"/> Crystal Golden Shadow (001 GSHA)	<input type="checkbox"/>

6680 Cosmic Pendant

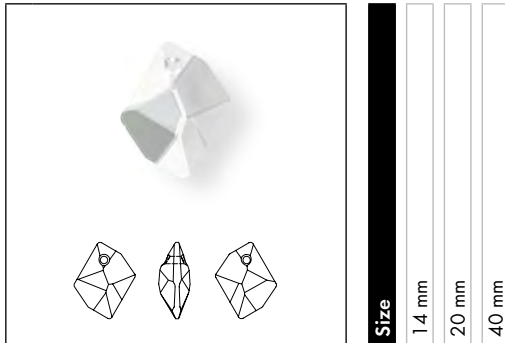

Crystal	
<input type="checkbox"/> Crystal (001)	<input type="checkbox"/>
Colors	
Plain Colors	
<input type="checkbox"/> Aquamarine (202)	<input type="checkbox"/>
<input type="checkbox"/> Violet (371)	<input type="checkbox"/>
Crystal Effects	
Transparent Effects	
<input type="checkbox"/> Crystal AB (001 AB)	<input type="checkbox"/>
<input type="checkbox"/> Crystal Golden Shadow (001 GSHA)	<input type="checkbox"/>

6685 Graphic Pendant



Crystal	
<input type="checkbox"/> Crystal (001)	<input type="checkbox"/>
Colors	
Plain Colors	
<input type="checkbox"/> Amethyst (204)	<input type="checkbox"/>
<input type="checkbox"/> Aquamarine (202)	<input type="checkbox"/>
<input type="checkbox"/> Denim Blue (266)	<input type="checkbox"/>
<input type="checkbox"/> Emerald (205)	<input type="checkbox"/>
Crystal Effects	
Transparent Effects	
<input type="checkbox"/> Crystal AB (001 AB)	<input type="checkbox"/>
<input type="checkbox"/> Crystal Golden Shadow (001 GSHA)	<input type="checkbox"/>

¹ For details about the protective coating, please refer to the chapter 'Basic Information'.

PENDANTS

6690 Wing Pendant

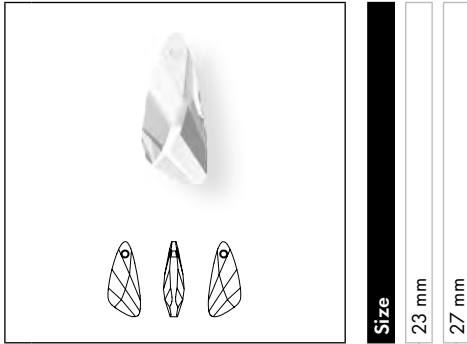

Size
23 mm
27 mm

Crystal	
Crystal (001)	
Colors	
Plain Colors	
Aquamarine (202)	
Capri Blue (243)	
Tanzanite (539)	
Crystal Effects	
Transparent Effects	
Crystal AB (001 AB)	
Crystal Golden Shadow (001 GSHA)	
Crystal Silver Night (001 SINI)	

6696 Urban Pendant

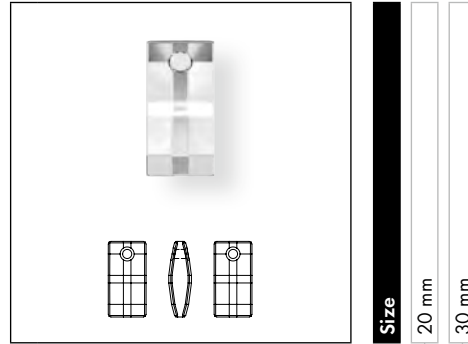

Size
20 mm
30 mm

Crystal	
Crystal (001)	
Colors	
Plain Colors	
Denim Blue (266)	
Crystal Effects	
Transparent Effects	
Crystal AB (001 AB)	
Crystal Bermuda Blue P (001 BBL) ¹	
Crystal Golden Shadow (001 GSHA)	
Crystal Silver Night (001 SINI)	
Metallic Effects	
Crystal Comet Argent Light V P (001 CAL V) ¹	

6704 Snowflake Pendant

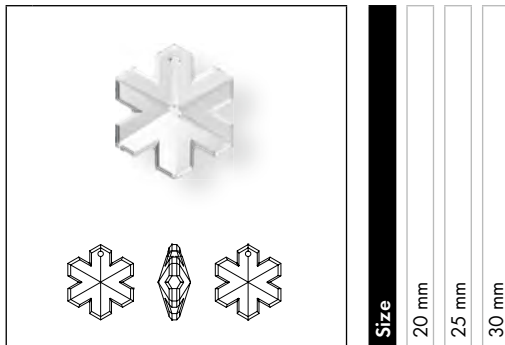

Size
20 mm
25 mm
30 mm

Crystal	
Crystal (001)	
Crystal Effects	
Transparent Effects	
Crystal AB (001 AB)	
Crystal Blue Shade (001 BLSH)	

6714 Star Pendant

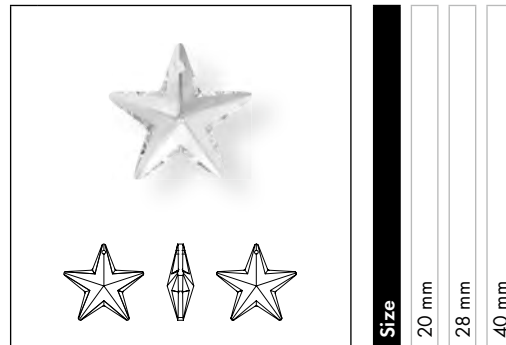

Size
20 mm
28 mm
40 mm

Crystal	
Crystal (001)	
Colors	
Plain Colors	
Jet (280)	
Crystal Effects	
Transparent Effects	
Crystal AB (001 AB)	

¹ For details about the protective coating, please refer to the chapter 'Basic Information'.

PENDANTS

6721 Starfish Pendant

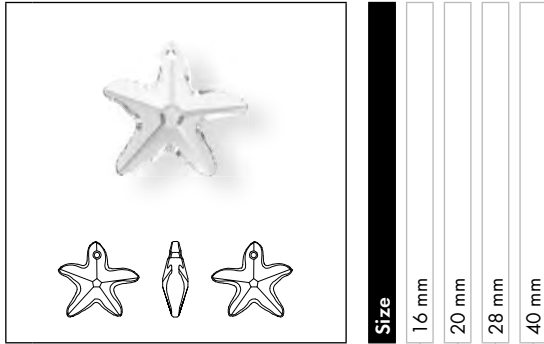

Crystal	16 mm	20 mm	28 mm	40 mm
Crystal (001)	■	■	■	■
Colors				
Plain Colors				
Aquamarine (202)	■	■		
Indicolite (379)	■	■		
Crystal Effects				
Transparent Effects				
Crystal AB (001 AB)	■	■	■	■
Crystal Bermuda Blue P (001 BBL) ¹	■	■	■	
Crystal Golden Shadow (001 GSHA)	■	■	■	

6722 Moon Pendant

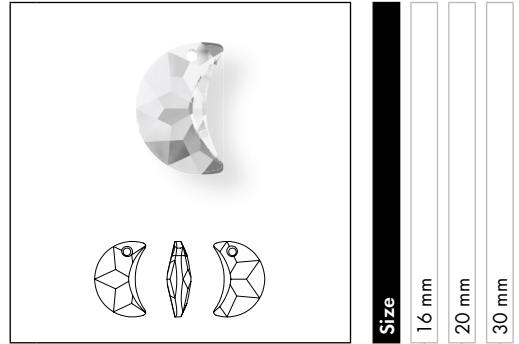

Crystal	16 mm	20 mm	30 mm
Crystal (001)	■	■	■
Crystal Effects			
Transparent Effects			
Crystal AB (001 AB)	■	■	■

6723 Shell Pendant

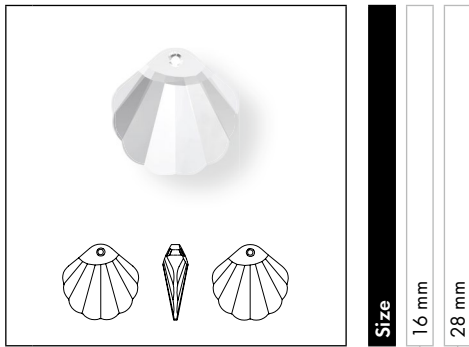

Crystal	16 mm	28 mm
Crystal (001)	■	■
Colors		
Plain Colors		
Aquamarine (202)	■	
Crystal Effects		
Transparent Effects		
Crystal AB (001 AB)	■	■
Crystal Golden Shadow (001 GSHA)	■	■

¹ For details about the protective coating, please refer to the chapter 'Basic Information'.

PENDANTS

6724 Sun Pendant

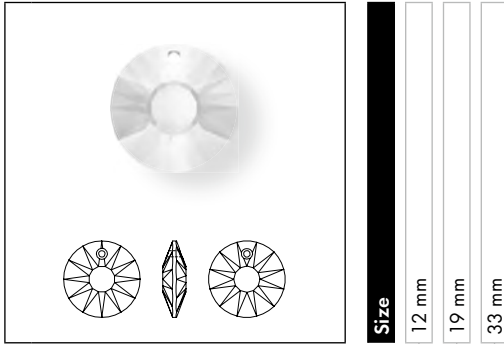

Size
12 mm
19 mm
33 mm

Crystal		
Crystal (001)	■	■
Crystal Effects		
Transparent Effects		
Crystal AB (001 AB)	■	■
Crystal Bermuda Blue P (001 BBL) ¹	■	■
Crystal Golden Shadow (001 GSHA)	■	■
Crystal Heliotrope P (001 HEL) ¹	■	■
Crystal Paradise Shine V (001 PARSH V)	■	■
Crystal Sahara P (001 SAH) ¹	■	■
Crystal Silver Night (001 SINI)	■	■
Crystal Vitrail Light P (001 VL) ¹	■	■
Crystal Vitrail Medium P (001 VM) ¹	■	■
Crystal Volcano P (001 VOL) ¹	■	■

6724/G Sun Pendant partly frosted

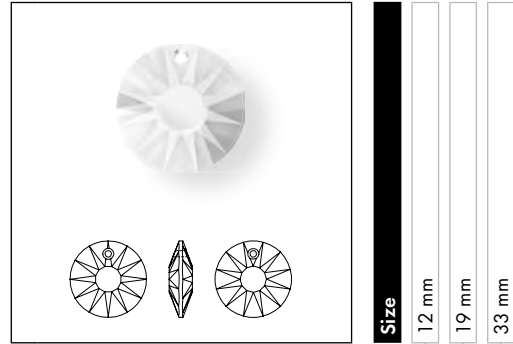

Size
12 mm
19 mm
33 mm

Crystal		
Crystal (001)	■	■
Crystal Effects		
Transparent Effects		
Crystal AB V (001 AB V)	■	■
Crystal Bermuda Blue P (001 BBL) ¹	■	■
Crystal Golden Shadow V (001 GSHA V)	■	■
Crystal Heliotrope P (001 HEL) ¹	■	■
Crystal Paradise Shine V (001 PARSH V)	■	■
Crystal Sahara P (001 SAH) ¹	■	■
Crystal Silver Night (001 SINI)	■	■
Crystal Vitrail Light P (001 VL) ¹	■	■
Crystal Vitrail Medium P (001 VM) ¹	■	■
Crystal Volcano P (001 VOL) ¹	■	■

¹ For details about the protective coating, please refer to the chapter 'Basic Information'.

OCEAN MYSTERIES DESIGNED
BY CÉLINE COUSTEAU

Design Story: A love for the sea runs through her veins: Céline Cousteau is a celebrated filmmaker, humanitarian, and environmentalist, and, as it so happens, the granddaughter of legendary ocean explorer Jacques Yves Cousteau. She presents her first ever crystal designs for Swarovski, inspired by one of her favorite places, the depths of the ocean. Taking inspiration from nature itself

and leaving its beauty unaltered, her stunningly life-like creatures are not only captivating and spellbinding, they also draw attention toward the mysterious, mostly unseen, and unexplored world beneath the ocean's surface on which all ocean life depends. These mysteries need to be protected for future generations, both above and below the water.

6730 Radiolarian Pendant partly frosted



Size 18x11.5 mm (with cavity)

6730 Radiolarian Pendant partly frosted



Size 34x22 mm (with clearance holes)

6730	Size	18x11.5 mm	34x22 mm
Crystal			
Crystal (001)			
Colors			
Plain Colors			
Blush Rose (257)			
Tanzanite (539)			
Opal Colors			
White Opal (234)			
Crystal Effects			
Transparent Effects			
Crystal AB (001 AB)			
Crystal Bermuda Blue P (001 BBL) ¹			
Crystal Bermuda Blue V P (001 BBL V) ¹			
Crystal Blue Shade (001 BLSH)			
Crystal Golden Shadow (001 GSHA)			
Crystal Luminous Green (001 LUMG)			
Crystal Silver Night (001 SINI)			
Crystal Silver Night V (001 SINI V)			
Crystal Silver Shade (001 SSHA)			

¹ For details about the protective coating, please refer to the chapter 'Basic Information'.

6731 Sea Snail Pendant partly frosted



Size 14 mm (with cavity)

6731 Sea Snail Pendant partly frosted



Size 28 mm (with clearance holes)

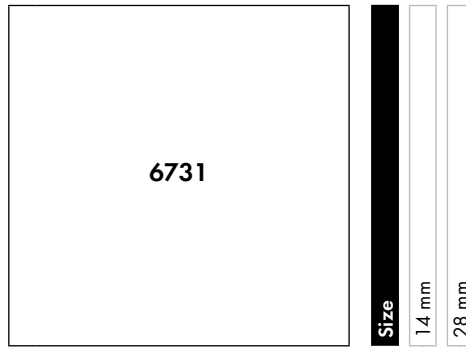

Crystal	14 mm	28 mm
Crystal (001)	<input type="checkbox"/>	<input type="checkbox"/>
Colors		
Plain Colors		
Blush Rose (257)	<input type="checkbox"/>	<input type="checkbox"/>
Tanzanite (539)	<input type="checkbox"/>	<input type="checkbox"/>
Opal Colors		
White Opal (234)	<input type="checkbox"/>	<input type="checkbox"/>
Crystal Effects		
Transparent Effects		
Crystal AB (001 AB)	<input type="checkbox"/>	<input type="checkbox"/>
Crystal Bermuda Blue P (001 BBL) ¹	<input type="checkbox"/>	<input type="checkbox"/>
Crystal Bermuda Blue V P (001 BBL V) ¹	<input type="checkbox"/>	<input type="checkbox"/>
Crystal Blue Shade (001 BLSH)	<input type="checkbox"/>	<input type="checkbox"/>
Crystal Golden Shadow (001 GSHA)	<input type="checkbox"/>	<input type="checkbox"/>
Crystal Luminous Green (001 LUMG)	<input type="checkbox"/>	<input type="checkbox"/>
Crystal Silver Night (001 SINI)	<input type="checkbox"/>	<input type="checkbox"/>
Crystal Silver Night V (001 SINI V)	<input type="checkbox"/>	<input type="checkbox"/>
Crystal Silver Shade (001 SSHA)	<input type="checkbox"/>	<input type="checkbox"/>

¹ For details about the protective coating, please refer to the chapter 'Basic Information'.

PENDANTS

DESIGNER EDITION

THE CÉLINE COUSTEAU DESIGNER EDITION FAMILY



1695 chapter 01 Round Stones
10, 14 mm p. 86



1695/S chapter 01 Round Stones
10, 14 mm p. 86



2612 chapter 07 Flat Backs No Hotfix
6, 10, 14 mm p. 360



2612 chapter 08 Flat Backs Hotfix
6, 10, 14 mm p. 396



4195 chapter 02 Fancy Stones & Settings
14, 18, 22 mm p. 103



4195/S chapter 02 Fancy Stones & Settings
14, 18, 22 mm p. 103



6730 chapter 06 Pendants
18x11.5, 34x22 mm p. 321



6731 chapter 06 Pendants
14, 28 mm p. 322

DESIGNER EDITIONS - DISTINCT PACKAGING

This Designer Edition will be labelled with the
"Designer Edition" imprint directly on the packaging.

PENDANTS

6734 Pure Leaf Pendant

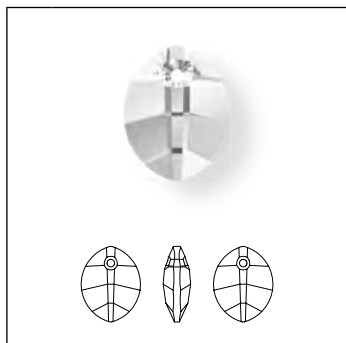

Size 14 mm

6734 Pure Leaf Pendant

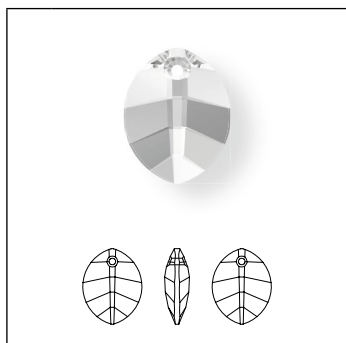

Size 23 mm

6734

Crystal					
Crystal (001)	■	■	■	■	■
Colors					
Plain Colors					
Fern Green (291)	■	■	■	■	■
Crystal Effects					
Transparent Effects					
Crystal AB (001 AB)	■	■	■	■	■
Crystal Blue Shade (001 BLSH)	■	■	■	■	■
Crystal Golden Shadow (001 GSHA)	■	■	■	■	■
Crystal Silver Night (001 SINI)	■	■	■	■	■

6735 Leaf Pendant

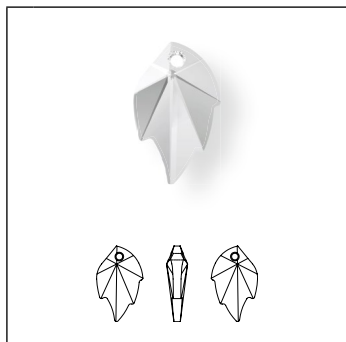

Size 26x16 mm

Crystal					
Crystal (001)	■	■	■	■	■
Crystal Effects					
Transparent Effects					
Crystal AB (001 AB)	■	■	■	■	■
Crystal Golden Shadow (001 GSHA)	■	■	■	■	■

6744 Flower Pendant

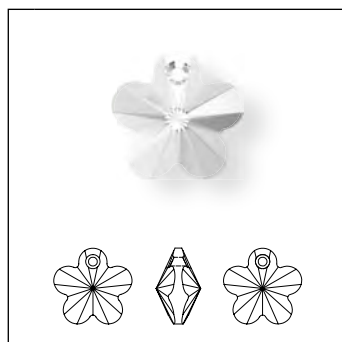

Size 12 mm 14 mm 18 mm

Crystal					
Crystal (001)	■	■	■	■	■
Crystal Effects					
Transparent Effects					
Crystal AB (001 AB)	■	■	■	■	■
Crystal Golden Shadow (001 GSHA)	■	■	■	■	■

PENDANTS

6748 Edelweiss Pendant

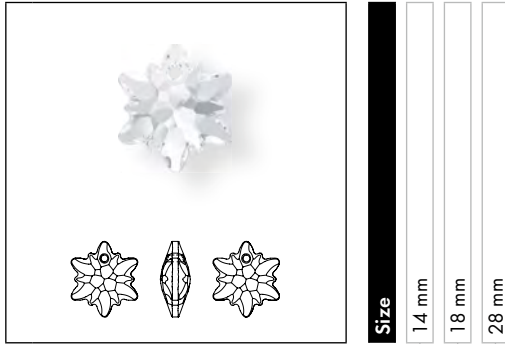

Crystal

Crystal (001)

Colors

Plain Colors

Amethyst (204)

Aquamarine (202)

Light Siam (227)

Vintage Rose (319)

Opal Colors

White Opal (234)

Crystal Effects

Transparent Effects

Crystal AB (001 AB)

Crystal Blue Shade (001 BLSH)

Crystal Golden Shadow (001 GSHA)

Crystal Luminous Green (001 LUMG)

Crystal Silver Night (001 SINI)

6748/G Edelweiss Pendant partly frosted

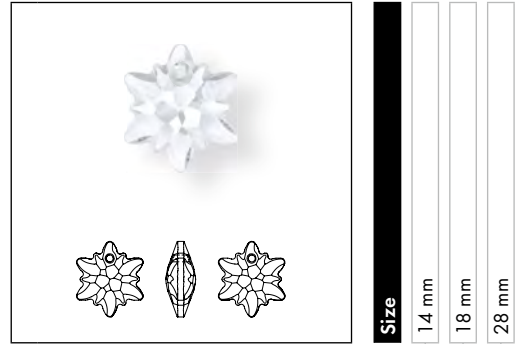

Crystal

Crystal (001)

Crystal Effects

Transparent Effects

Crystal AB (001 AB)

Crystal Blue Shade (001 BLSH)

Crystal Golden Shadow (001 GSHA)

Crystal Luminous Green (001 LUMG)

Crystal Silver Night (001 SINI)

PENDANTS

6754 Butterfly Pendant

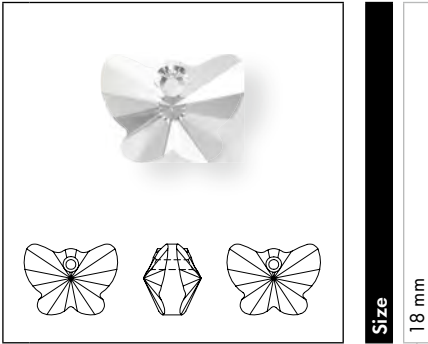

Size
18 mm

- Crystal**
- Crystal (001)
- Crystal Effects**
- Transparent Effects**
- Crystal Golden Shadow (001 GSHA)

6764 Clover Pendant

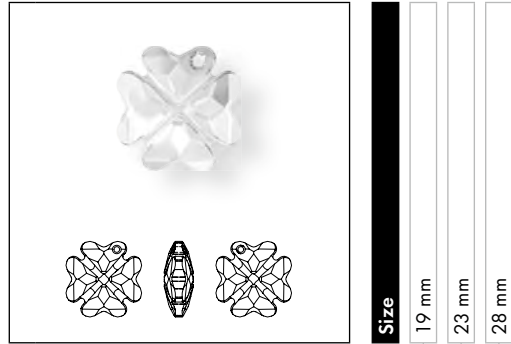

Size
19 mm
23 mm
28 mm

- Crystal**
- Crystal (001)
- Colors**
- Plain Colors**
- Emerald (205)
- Crystal Effects**
- Transparent Effects**
- Crystal AB (001 AB)
- Crystal Golden Shadow (001 GSHA)
- Crystal Paradise Shine (001 PARSH)
- Crystal Silver Night (001 SINI)

6792 Infinity Pendant

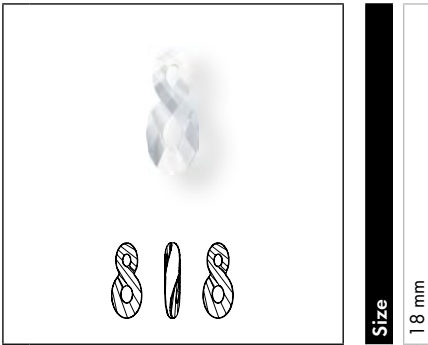

Size
18 mm

- Crystal**
- Crystal (001)
- Colors**
- Plain Colors**
- Jet (280)
- Crystal Effects**
- Transparent Effects**
- Crystal AB (001 AB)
- Crystal Golden Shadow (001 GSHA)
- Crystal Paradise Shine (001 PARSH)
- Crystal Silver Night (001 SINI)
- Crystal Silver Shade (001 SSHA)
- Metallic Effects**
- Crystal Metallic Light Gold 2x (001 MGLD2)
- Crystal Rose Gold 2x (001 ROGL2)

6860

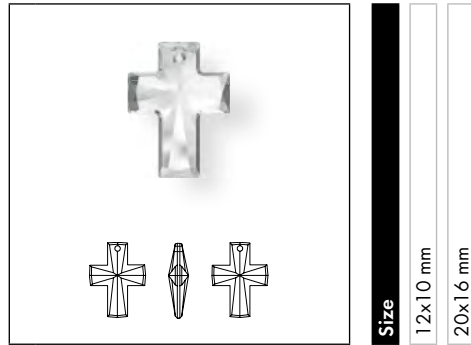

Size
12x10 mm
20x16 mm

- Crystal**
- Crystal (001)

PENDANTS

6864

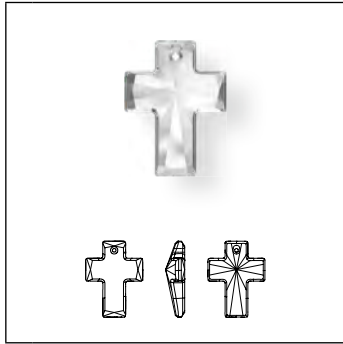

Size
40x30 mm

- Crystal**
- Crystal (001)
- Crystal Effects**
- Transparent Effects**
- Crystal AB V (001 AB V)

6866

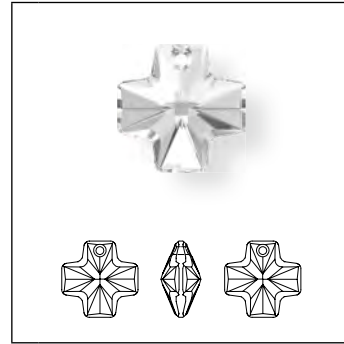

Size
20 mm

- Crystal**
- Crystal (001)
- Crystal Effects**
- Transparent Effects**
- Crystal AB (001 AB)
- Crystal Golden Shadow (001 GSHA)
- Crystal Heliotrope (001 HEL)

6867 Greek Cross Pendant

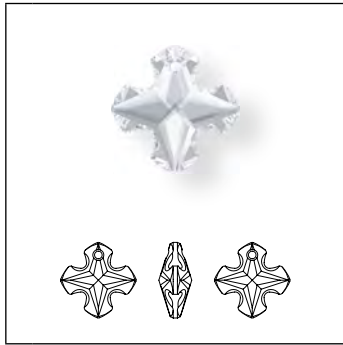

Size
14 mm
18 mm
28 mm

- Crystal**
- Crystal (001)
- Colors**
- Plain Colors**
- Jet (280)
- Crystal Effects**
- Transparent Effects**
- Crystal AB (001 AB)
- Crystal Antique Pink (001 ANTP)
- Crystal Bermuda Blue P (001 BBL)¹
- Crystal Blue Shade (001 BLSH)
- Crystal Golden Shadow (001 GSHA)
- Crystal Luminous Green (001 LUMG)
- Crystal Silver Night (001 SINI)
- Crystal Vitrail Medium P (001 VM)¹
- Metallic Effects**
- Crystal Metallic Sunshine (001 METSH)
- Crystal Rose Gold 2x (001 ROGL2)

¹ For details about the protective coating, please refer to the chapter 'Basic Information'.

TRIBUTE TO TRIBE COLLECTION DESIGNED BY CÉLINE COUSTEAU

Design Story: Céline Cousteau, the granddaughter of legendary ocean explorer Jacques-Yves Cousteau, is a celebrated filmmaker, environmentalist, and like Daniel Swarovski a genuine humanitarian. Having been raised with a deep-rooted respect for our planet and all its inhabitants – both in the water and on the land – Céline Cousteau recently took up a project in the Brazilian Amazon region, where she has become an ambassador for an indigenous tribe of roughly 6,000 people living in an area the size of Austria. These tribe members – about

one-third of them considered “uncontacted” – have chosen Céline Cousteau to tell their story.

Her designs are inspired by tribal patterns either painted or tattooed on bare skin. They are symbolic of a pristine coexistence with nature and as such are part of a long tradition in which it has always been natural for man to decorate himself, be it for reasons of aesthetics, status, or celebration.

6868 Cross Tribe Pendant

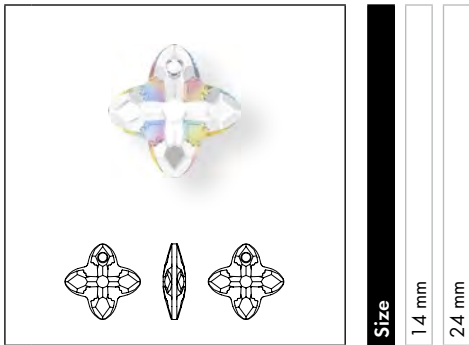

Crystal Effects		
Transparent Effects		
Crystal AB Z (001 AB)	■	■
Color Effects		
Metallic Effects		
Aquamarine Metallic Blue Z (202 METBL)	■	■
Graphite Light Chrome Z (253 LTCH)	■	■
Light Siam Metallic Light Gold Z (227 MLGLD)	■	■
Peridot Scarabaeus Green*** Z (214 SCGR)	■	■
Topaz Dorado Z (203 DOR)	■	■

*** designed by Jean Paul Gaultier

THE CÉLINE COUSTEAU
DESIGNER EDITION FAMILY



4926 Oval Tribe
Fancy Stone
14x10, 19x14 mm

chapter 02 Fancy Stones & Settings
p. 170



4926/S
14x10, 19x14 mm

chapter 02 Fancy Stones & Settings
p. 170



4927 Rhombus Tribe
Fancy Stone
14x12, 19x17 mm

chapter 02 Fancy Stones & Settings
p. 171



4927/S
14x12, 19x17 mm

chapter 02 Fancy Stones & Settings
p. 171



6868 Cross Tribe
Pendant
14, 24 mm

chapter 06 Pendants
p. 328

DESIGNER EDITIONS - DISTINCT PACKAGING

This Designer Edition will be labelled with the
"Designer Edition" imprint directly on the packaging.

PENDANTS

6871 Buddha Pendant

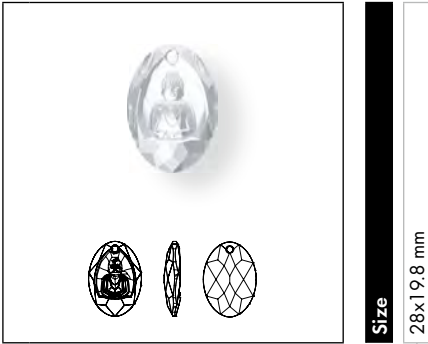

Size

28x19.8 mm

Crystal

Crystal (001)

Crystal Effects

Transparent Effects

Crystal AB (001 AB)

Crystal Astral Pink (001 API)

Crystal Blue Shade (001 BLSH)

Crystal Golden Shadow (001 GSHA)

Crystal Luminous Green (001 LUMG)

Crystal Silver Night (001 SINI)

Crystal Silver Shade (001 SSHA)

KAPUTT DESIGNED BY JEAN PAUL GAULTIER

Design Story: While the whole world strives for perfection, Swarovski discovers the beauty of imperfection, guided and inspired by none other than design legend Jean Paul Gaultier. Together with Swarovski's own trend, design and product management experts, Gaultier developed the spectacular Kaputt Collection exclusively for Swarovski. Like its name, the German word for "broken," already suggests, the collection presents a technological innovation that deliberately breaks with convention. It celebrates the appeal of being different and unpredictable, which, according to the designer, is much more exciting than the precise and perfect.

Description: Broken and raw, but elegant at the same time, the Kaputt design captivates with distinctively irregular, partly unpolished, or frosted surfaces that give it an all natural, almost meteoritic appearance. It comes in rich, shimmering metallic colors as well as classics, such as Crystal and GSHA, and boasts the famous Jean Paul Gaultier logo as a laser engraving.

Look: In a world of flawless, artificial beauty, Kaputt mirrors the attractiveness of irregular, natural surfaces for a down-to-earth look that is both rock and chic.

6910 Kaputt Oval Pendant

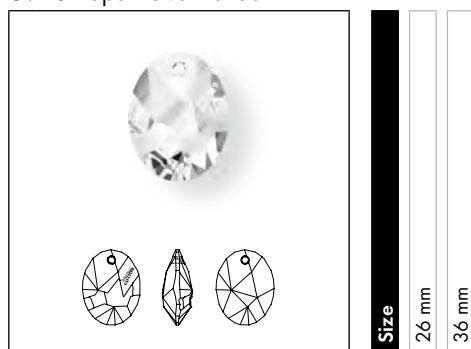

Crystal		
Crystal (001)	<input type="checkbox"/>	<input type="checkbox"/>
Crystal Effects		
Transparent Effects		
Crystal AB (001 AB)	<input type="checkbox"/>	<input type="checkbox"/>
Crystal Golden Shadow (001 GSHA)	<input type="checkbox"/>	<input type="checkbox"/>
Crystal Red Magma (001 REDM)	<input type="checkbox"/>	<input type="checkbox"/>
Crystal Silver Night (001 SINI)	<input type="checkbox"/>	<input type="checkbox"/>
Crystal Volcano P (001 VOL) ¹	<input type="checkbox"/>	<input type="checkbox"/>
Metallic Effects		
Crystal Dorado (001 DOR)	<input type="checkbox"/>	<input type="checkbox"/>
Crystal Light Chrome (001 LTCH)	<input type="checkbox"/>	<input type="checkbox"/>
Crystal Metallic Blue (001 METBL)	<input type="checkbox"/>	<input type="checkbox"/>
Crystal Metallic Light Gold (001 MLGLD)	<input type="checkbox"/>	<input type="checkbox"/>
Crystal Scarabaeus Green (001 SCGR) ^{***}	<input type="checkbox"/>	<input type="checkbox"/>

6911 Kaputt Oval Pendant

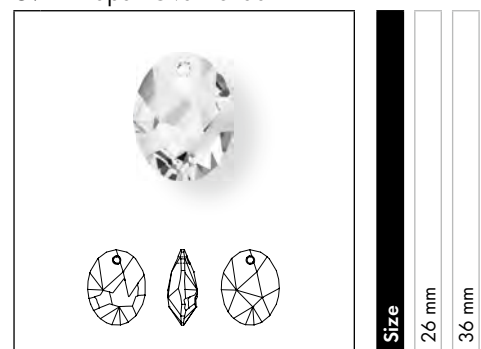

Crystal		
Crystal (001)	<input type="checkbox"/>	<input type="checkbox"/>
Crystal Effects		
Transparent Effects		
Crystal AB (001 AB)	<input type="checkbox"/>	<input type="checkbox"/>
Crystal Golden Shadow (001 GSHA)	<input type="checkbox"/>	<input type="checkbox"/>
Crystal Red Magma (001 REDM)	<input type="checkbox"/>	<input type="checkbox"/>
Crystal Silver Night (001 SINI)	<input type="checkbox"/>	<input type="checkbox"/>
Crystal Volcano P (001 VOL) ¹	<input type="checkbox"/>	<input type="checkbox"/>
Metallic Effects		
Crystal Dorado (001 DOR)	<input type="checkbox"/>	<input type="checkbox"/>
Crystal Light Chrome (001 LTCH)	<input type="checkbox"/>	<input type="checkbox"/>
Crystal Metallic Blue (001 METBL)	<input type="checkbox"/>	<input type="checkbox"/>
Crystal Metallic Light Gold (001 MLGLD)	<input type="checkbox"/>	<input type="checkbox"/>
Crystal Scarabaeus Green (001 SCGR) ^{***}	<input type="checkbox"/>	<input type="checkbox"/>

*** designed by Jean Paul Gaultier

¹ For details about the protective coating, please refer to the chapter 'Basic Information'.

6912 Kaputt Pendant

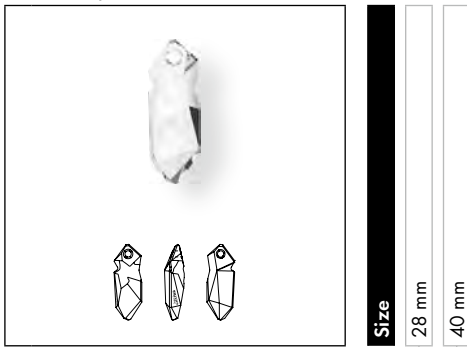





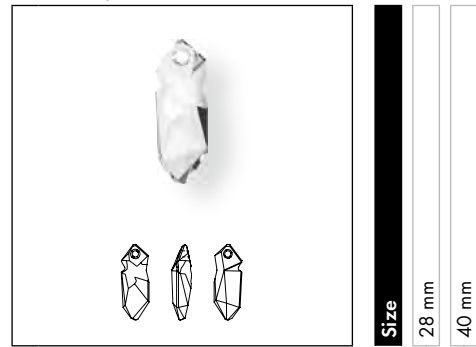

Crystal	
<input type="checkbox"/>	Crystal (001)
Crystal Effects	
Transparent Effects	
<input type="checkbox"/>	Crystal AB (001 AB)
<input type="checkbox"/>	Crystal Golden Shadow (001 GSHA)
<input type="checkbox"/>	Crystal Red Magma (001 REDM)
<input type="checkbox"/>	Crystal Silver Night (001 SINI)
<input type="checkbox"/>	Crystal Volcano P (001 VOL) ¹
Metallic Effects	
<input type="checkbox"/>	Crystal Dorado (001 DOR)
<input type="checkbox"/>	Crystal Light Chrome (001 LTCH)
<input type="checkbox"/>	Crystal Metallic Blue (001 METBL)
<input type="checkbox"/>	Crystal Metallic Light Gold (001 MLGLD)
<input type="checkbox"/>	Crystal Scarabaeus Green (001 SCGR) ^{***}







6913 Kaputt Pendant



Crystal	
<input type="checkbox"/>	Crystal (001)
Crystal Effects	
Transparent Effects	
<input type="checkbox"/>	Crystal AB (001 AB)
<input type="checkbox"/>	Crystal Golden Shadow (001 GSHA)
<input type="checkbox"/>	Crystal Red Magma (001 REDM)
<input type="checkbox"/>	Crystal Silver Night (001 SINI)
<input type="checkbox"/>	Crystal Volcano P (001 VOL) ¹
Metallic Effects	
<input type="checkbox"/>	Crystal Dorado (001 DOR)
<input type="checkbox"/>	Crystal Light Chrome (001 LTCH)
<input type="checkbox"/>	Crystal Metallic Blue (001 METBL)
<input type="checkbox"/>	Crystal Metallic Light Gold (001 MLGLD)
<input type="checkbox"/>	Crystal Scarabaeus Green (001 SCGR) ^{***}

THE KAPUTT DESIGNER EDITION FAMILY

-  **4920** Kaputt Oval Fancy Stone
23x18, 29x22.5 mm chapter 02 Fancy Stones & Settings p. 166
-  **4921** Kaputt Oval Fancy Stone
23x18, 29x22.5 mm chapter 02 Fancy Stones & Settings p. 166
-  **4921/S¹**
23x18, 29x22.5 mm chapter 02 Fancy Stones & Settings p. 166
-  **4922** Kaputt Fancy Stone
28x24, 38x33 mm chapter 02 Fancy Stones & Settings p. 167
-  **4923** Kaputt Fancy Stone
28x24, 38x33 mm chapter 02 Fancy Stones & Settings p. 167
-  **4923/S²**
28x24, 38x33 mm chapter 02 Fancy Stones & Settings p. 167
-  **4924** Kaputt Baguette Fancy Stone
23x9, 29x11.5 mm chapter 02 Fancy Stones & Settings p. 168

-  **4925** Kaputt Baguette Fancy Stone
23x9, 29x11.5 mm chapter 02 Fancy Stones & Settings p. 168
-  **4925/S³**
23x9, 29x11.5 mm chapter 02 Fancy Stones & Settings p. 168
-  **6910** Kaputt Oval Pendant
26, 36 mm chapter 06 Pendants p. 331
-  **6911** Kaputt Oval Pendant
26, 36 mm chapter 06 Pendants p. 331
-  **6912** Kaputt Pendant
28, 40 mm chapter 06 Pendants p. 332
-  **6913** Kaputt Pendant
28, 40 mm chapter 06 Pendants p. 332

^{***} designed by Jean Paul Gaultier

¹ For details about the protective coating, please refer to the chapter 'Basic Information'.

² The Setting 4921/S for article 4921 can also be used for article 4920

³ The Setting 4923/S for article 4923 can also be used for article 4922

⁴ The Setting 4925/S for article 4925 can also be used for article 4924

YOKO ONO

Yoko Ono is a multi-media artist whose thought provoking work challenges people's understanding of art and the world around them.

Her work as a conceptualist has encompassed performance, instructions, film, music, writing, and now jewelry inspiration for Swarovski.

Born in Tokyo in 1933, she moved to New York in 1953, where she became part of the city's vibrant avant-garde scene. She went on to perform and exhibit what have now become legendary works in the history of contemporary art, including her famous 1969 collaboration, *Bed-In*, with husband John Lennon.

She has had numerous exhibitions in museums, and in 2009, received the Golden Lion for Lifetime Achievement from the Venice Biennale. In 2011 Ono was honored with the prestigious 8th Hiroshima Art Prize for her dedicated peace activism, and in 2012 received the Oskar Kokoschka Prize in Vienna.

THE COOPERATION

A memorable key-shaped crystal pendant, inspired by Yoko Ono, has been designed for Swarovski. The design itself is a technical masterwork and tells us a wonderful story around the symbol key.

THE STORY

**"Imagine a key that unlocks the door
to the forest with its secrets,
to the sky with its peacefulness,
to the universe with its infinity,
to a future with the promise of a better life."
Yoko Ono**

This concept by Yoko Ono has been created as a crystal "KEY TO OPEN THE FOREST" exclusively for our Swarovski collection. It embodies the spirits of earth and sky, and reflects the multiple colors of nature. "Make a promise to a tree. Ask it to be passed on to other trees." When you wear it you will be sharing Yoko's dream of peaceful interaction with the world around you. "Whisper your dream to a cloud. Ask the cloud to remember it." A memorable key-shaped crystal pendant, inspired by Yoko Ono, has been designed for Swarovski. The design itself is a technical masterwork and tells us a wonderful story around the symbol key.

6919 Key Pendant

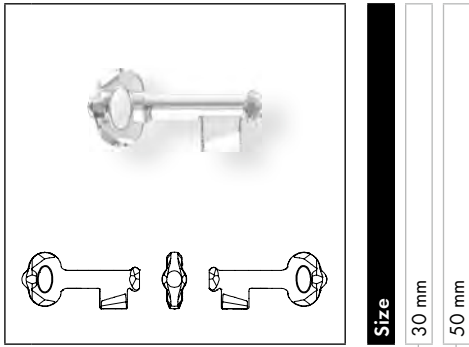

Crystal	30 mm	50 mm
Crystal (001)	■	■
Colors		
Plain Colors		
Indian Sapphire (217)	■	
Crystal Effects		
Transparent Effects		
Crystal AB (001 AB)	■	■
Crystal Blue Shade (001 BLSH)	■	
Crystal Golden Shadow (001 GSHA)	■	■
Crystal Silver Night (001 SINI)	■	■
Crystal Silver Shade (001 SSHA)	■	

06 PENDANTS

DESIGNER EDITIONS - DISTINCT PACKAGING

This Designer Edition will be labelled with the "Designer Edition" imprint directly on the packaging.

PENDANTS

PRODUCT DETAILS

Article Size	Packing Unit = Minimum Order Quantity in Pieces	Average Net Weight in Grams per Packing Unit Crystal (001)	Average Gross Weight in Grams per Packing Unit Crystal (001)
6000			
11x5.5 mm	288	99.8	123.1
13x6.5 mm	288	156.9	197.5
15x7.5 mm	144	129.8	153.4
22x11 mm	48	129.4	151.3
28x14 mm	24	132.2	156.1
6002			
10x7 mm	144	91.4	109.3
15x11.5 mm	72	175.4	197.3
6007			
7x4 mm	360	46.7	55.8
9x5 mm	288	77.1	104.2
6010			
11x5.5 mm	144	57.4	75.9
13x6.5 mm	144	91.1	109.0
17x8.5 mm	36	57.3	77.2
21x10.5 mm	24	66.3	83.4
50x21.5 mm	6	173.71	222.8
6012			
11x10 mm	144	94.2	120.0
15.4x14 mm	72	126.0	157.3
6015			
17 mm	72	93.2	111.5
21 mm	48	105.9	129.3
50 mm	6	173.7	222.8
6017/G			
30 mm	12	25.0	45.6
56 mm	6	67.5	91.4
6019/G			
35 mm	8	52.4	74.6
6020			
18 mm	36	49.7	72.1
30 mm	12	74.3	95.5
37 mm	6	76.4	82.5
6022			
14 mm	72	77.2	97.0
24 mm	24	133.9	155.5
33 mm	8	111.6	139.0
6028			
8 mm	144	31.8	40.9
10 mm	192	71.0	97.7
12 mm	108	68.9	92.9
18 mm	72	146.5	170.3
6039			
25 mm	24	88.4	117.5
38 mm	9	92.7	123.8
6040			
20 mm	72	66.3	92.8
30 mm	30	85.4	116.4
40 mm	6	41.7	61.4

PENDANTS

Article Size	Packing Unit = Minimum Order Quantity in Pieces	Average Net Weight in Grams per Packing Unit Crystal (001)	Average Gross Weight in Grams per Packing Unit Crystal (001)
6041			
18 mm	30	38.3	63.1
28 mm	12	57.9	80.2
38 mm	6	65.3	88.3
6049			
20 mm	72	170.5	200.4
30 mm	24	166.7	209.2
6090			
16x11 mm	72	55.8	75.8
22x15 mm	48	102.2	136.7
6100			
24x12 mm	36	54.5	83.9
6106			
16 mm	144	129.9	158.3
22 mm	96	208.1	248.5
28 mm	36	171.8	201.1
38 mm	9	91.1	121.6
50 mm	6	146.1	177.9
6110			
30x14 mm	36	147.6	178.8
40x18 mm	12	132.6	159.2
6128			
8 mm	144	23.2	34.0
10 mm	144	52.3	80.0
12 mm	144	81.8	101.3
6150			
30 mm	48	140.6	174.5
50 mm	9	109.2	140.7
6210			
12 mm	144	67.8	90.9
17 mm	72	98.8	122.0
6215			
18 mm	72	183.2	210.5
6225			
10 mm	144	48.3	68.4
18 mm	24	41.6	59.0
28 mm	24	160.7	206.2
6228			
10.3x10 mm	288	124.6	152.6
14.4x14 mm	144	181.4	210.5
18x17.5 mm	72	188.0	211.7
28 mm	16	124.0	158.7
40 mm	6	137.9	169.2
6240			
12 mm	108	63.3	83.5
17 mm	72	116.4	137.0
27 mm	24	142.6	147.8
37 mm	6	80.9	109.3

PENDANTS

Article Size	Packing Unit = Minimum Order Quantity in Pieces	Average Net Weight in Grams per Packing Unit Crystal (001)	Average Gross Weight in Grams per Packing Unit Crystal (001)
6261			
17 mm	48	48.2	76.6
27 mm	20	77.0	102.6
36 mm	12	112.5	135.3
6262			
17 mm	48	67.9	91.9
26 mm	16	74.0	92.5
34 mm	6	53.7	80.3
6264			
18 mm	48	93.4	109.1
28 mm	16	93.7	118.2
6320			
14 mm	96	48.2	70.0
19 mm	48	61.6	78.3
27 mm	24	89.1	101.3
6328			
6 mm	360	78.5	89.5
8 mm	288	153.2	173.2
6401			
8 mm	288	106.8	123.8
12 mm	144	164.9	182.7
6428			
6 mm	720	80.1	89.5
8 mm	144	37.4	46.7
12 mm	144	121.8	141.6
6460			
20 mm	72	60.3	83.1
6465			
13.5x6 mm	72	40.3	61.4
25x7 mm	36	51.9	75.75
38x10 mm	24	89.3	125.72
6470			
32 mm	36	82.5	100.3
40 mm	18	84.1	114.4
6480			
18 mm	48	42.7	64.1
28 mm	36	101.6	130.5
39 mm	16	105.6	133.7
6530			
12 mm	96	55.7	73.0
20 mm	48	67.7	87.8
30 mm	24	74.6	95.3
6531			
15.5 mm	48	30.6	47.9
24 mm	24	35.9	56.1
34 mm	12	39.6	60.2
6532			
21 mm	24	17.9	38.5
31.5 mm	20	33.1	55.7
44 mm	16	55.0	88.4

PENDANTS

06 PENDANTS

Article Size	Packing Unit = Minimum Order Quantity in Pieces	Average Net Weight in Grams per Packing Unit Crystal (001)	Average Gross Weight in Grams per Packing Unit Crystal (001)
6533			
17.5 mm	36	11.6	31.8
23 mm	24	14.6	35.4
33 mm	12	22.7	43.4
6540			
12 mm	96	66.2	88.1
20 mm	48	99.4	120.0
30 mm	24	136.3	157.0
6541			
14.5 mm	48	34.9	53.5
24 mm	24	50.6	67.6
34.5 mm	12	68.6	85.6
65M001			
9 mm	96	15.9	34.4
11.5 mm	48	11.7	30.0
14 mm	24	7.9	23.2
65M002			
3.5 mm	48	2.7	18.0
4 mm	24	2.1	17.3
4.5 mm	24	4.6	19.8
65M003			
2.5 mm	96	1.8	17.1
6621			
18 mm	72	192.8	212.7
28 mm	24	190.8	217.8
6628			
8 mm	288	72.6	72.8
12 mm	144	101.6	126.9
16 mm	72	128.2	155.1
6650			
22 mm	24	101.5	119.7
6656			
19 mm	48	72.3	94.2
27 mm	30	126.1	159.6
39 mm	6	61.8	82.0
6670			
18 mm	72	68.4	104.6
24 mm	48	105.5	161.9
50 mm	6	104.7	126.8
6673			
18 mm	48	59.7	80.7
28 mm	20	89.0	112.2
38 mm	6	69.5	87.1
6680			
14 mm	144	118.7	145.1
20 mm	72	167.5	191.1
40 mm	12	146.3	171.9
6685			
19 mm	48	104.5	127.4
28 mm	24	168.7	175.4

PENDANTS

Article Size	Packing Unit = Minimum Order Quantity in Pieces	Average Net Weight in Grams per Packing Unit Crystal (001)	Average Gross Weight in Grams per Packing Unit Crystal (001)
6690			
23 mm	36	54.5	88.6
27 mm	36	99.4	130.5
6696			
20 mm	24	53.5	70.6
30 mm	10	59.6	83.3
6704			
20 mm	48	131.4	155.0
25 mm	24	115.8	160.7
30 mm	16	128.1	164.1
6714			
20 mm	48	48.2	73.1
28 mm	24	112.5	156.1
40 mm	6	56.1	87.4
6721			
16 mm	72	105.1	131.7
20 mm	30	76.8	113.6
28 mm	12	66.3	93.7
40 mm	6	83.9	113.5
6722			
16 mm	72	63.9	87.2
20 mm	48	64.3	102.4
30 mm	20	113.8	131.3
6723			
16 mm	96	176.8	215.0
28 mm	18	126.6	160.3
6724			
12 mm	144	104.4	131.7
19 mm	45	127.7	157.8
33 mm	6	79.9	105.8
6724/G			
12 mm	144	105.9	131.7
19 mm	45	126.3	157.8
33 mm	6	80.1	105.8
6730			
18x11.5 mm	24	31.7	52.3
34x22 mm	8	55.6	76.7
6731			
14 mm	36	35.1	64.0
28 mm	8	76.4	98.2
6734			
14 mm	108	82.6	104.2
23 mm	30	88.5	111.6
6735			
26x16 mm	30	73.3	110.0
6744			
12 mm	144	118.7	145.4
14 mm	144	172.9	204.5
18 mm	72	174.8	207.2

PENDANTS

06 PENDANTS

Article Size	Packing Unit = Minimum Order Quantity in Pieces	Average Net Weight in Grams per Packing Unit Crystal (001)	Average Gross Weight in Grams per Packing Unit Crystal (001)
6748			
14 mm	72	65.3	90.0
18 mm	48	88.3	110.2
28 mm	18	115.7	145.4
6748/G			
14 mm	72	63.5	88.2
18 mm	48	82.3	104.1
28 mm	18	115.3	144.9
6754			
18 mm	72	217.0	248.3
6764			
19 mm	48	114.5	131.8
23 mm	24	95.76	138.4
28 mm	16	110.2	128.8
6792			
18 mm	48	30.7	56.1
6860			
12x10 mm	144	31.2	54.5
20x16 mm	72	48.2	73.1
6864			
40x30 mm	9	109.2	142.2
6866			
20 mm	72	249.5	272.8
6867			
14 mm	72	55.7	79.1
18 mm	48	77.7	101.4
28 mm	24	130.2	164.9
6868			
14 mm	36	21.4	39.8
24 mm	15	41.1	58.8
6871			
28 x 19.8 mm	10	34.7	57.3
6910			
26 mm	20	141.3	165.3
36 mm	9	150.4	180.5
6911			
26 mm	20	141.3	165.3
36 mm	9	150.4	180.5
6912			
28 mm	15	36.9	62.74
40 mm	8	58.2	80.5
6913			
28 mm	15	36.9	62.7
40 mm	8	58.2	80.5
6919			
30 mm	36	63.8	88.6
50 mm	6	43.6	66.5

PENDANTS