



08

## FLAT BACKS HOTFIX

Flat Backs Hotfix are loose crystal elements with a flat reverse side that has been pre-coated with a heat-sensitive glue. These Flat Backs can be easily applied to a large range of textile carrier materials using heat to produce a durable and long-lasting crystal effect.

Flat Backs Hotfix are available in a multitude of colors, shapes, and cuts. The increased light reflection and warmer appearance of the Flat Back Rose are achieved through a special silver mirror on the reverse side.

The most innovative single item in this product group is art. 2078 XIRIUS Rose, with its most progressive and unique cut in the market: multilayer cut technology, producing the inspiring XIRIUS star design. Superior shine and rich, well balanced refraction of light redefine the market standard.

Swarovski's outstanding quality in crystal elements are underlined by highest precision in table size and diameter.

COLORS & EFFECTS

OPEN TO SEE COLORS & EFFECTS

COLORS

	Crystal	001
	Crystal Hoelix Transparent 1	001 HFT
	Chalkwhite	279
	White Opal	234
	Light Silk	261
	Black Diamond	215
	Pacific Opal	362
	Vintage Rose	391
	Chrysalite	238
	Peridot	214
	Erinise	360
	Fern Green	291
	Emerald	205
	Olivine	228
	Khaki	550
	Graig	284
	Light Siam	227
	Light Colorado Topaz	246
	Jonquil	213
	Chirne	249
	Yellow Opal	501
	Light Topaz	226
	Sunflower	292
	Topaz	203
	Tanzanite	259
	Cobalt	369
	Tanzanite	286
	Grapehite	253
	Jet	280
	Crystal Silver Shade	265
	Crystal Moonlight	283
	Crystal Aurora Boreale	268
	Smoky Mauze	265
	Provence Lavender	283
	Light Sapphire	211
	Aquamarine	202
	Sapphire	206

CRYSTAL LACQUER\*PO

	Crystal Ivory Cream	001 L1065
	Crystal Powder Yellow	001 L101
	Crystal Powder Rose	001 L103
	Crystal Royal Red	001 L1075
	Crystal Dark Red	001 L1085
	Crystal Powder Blue	001 L104
	Crystal Royal Blue	001 L1105
	Crystal Powder Green	001 L102
	Crystal Royal Green	001 L1095
	Crystal Dark Gray	001 L1115
	Crystal White Patina	001 WHIPA
	Crystal Rose Patina	001 ROSPA
	Crystal Silver Patina	001 SILPA
	Crystal Gold Patina	001 GOLPA
	Crystal Blue Patina	001 BLAPA
	Crystal Blue Shadow	001 L10H
	Crystal Paradise Shine	001 PARSH
	Sapphire Shine	206 SAT
	Crystal Bermuda Blue	001 BBL
	Crystal Metallic Blue	001 METBL
	Crystal Meridian Blue	001 MBL
	Crystal Blue Shade	001 BLSH
	Crystal Scabrous Green	001 SCGR
	Crystal Rambow Dark	001 RABDK
	Blue Zircon Shine	229 SAT
	Jonquil Aurora Boreale	213 AB
	Jonquil Shine	213 SA1
	Sunflower	315
	Anethyl	204
	Purple Velvet	277
	Cobalt	369
	Tanzanite	286
	Smoked Topaz	220
	Tanzanite	286
	Grapehite	253
	Jet	280
	Crystal Silver Night	280 SIN1
	Jet Nur	280 NUT
	Crystal Silver Shade	265
	Crystal Moonlight	283
	Crystal Aurora Boreale	268

NUMERICAL ORDER

001	Crystal
001 HFT	Crystal Hoelix Transparent 1
001 191	Crystal Nacre
001 294	Crystal Crampfer
001 295	Crystal Rambow Dark
001 616	Crystal Metallic Sunshine
001 617	Crystal Light Gray Pearl
001 650	Crystal White Pearl
001 AB	Crystal Aurora Boreale
001 ANTP	Crystal Antique Pink
001 BBL	Crystal Bermuda Blue
001 BLAPA	Crystal Blue Patina
001 BSH	Crystal Blue Shade
001 BSH	Crystal Bronze Shade
001 COP	Crystal Copper
001 COS	Crystal Cosmjet 1
001 L104	Crystal Powder Blue
001 L105	Crystal Royal Blue
001 L102	Crystal Powder Green
001 L104	Crystal Powder Rose
001 L1065	Crystal Royal Green
001 L1075	Crystal Royal Red
001 L1085	Crystal Dark Red
001 L1095	Crystal Royal Green
001 L1105	Crystal Royal Blue
001 L101	Crystal Powder Yellow
001 L102	Crystal Powder Green
001 L104	Crystal Powder Blue
206 SAT	Sapphire Shine
208	Monara
209	Slam
211	Light Sapphire

ALPHABETICAL ORDER

001 L1115	Crystal Indescent Green
001 L10H	Crystal Blue Shadow
001 L101	Crystal Powder Yellow
001 METBL	Crystal Metallic Blue
001 METSH	Crystal Metallic Sunshine
001 MGLD	Crystal Moonlight
001 PARSH	Crystal Paradise Shine
001 SCGR	Crystal Scabrous Green
001 RABDK	Crystal Rambow Dark
001 ROGL	Crystal Rose Gold
001 ROSPA	Crystal Rose Patina
001 SIN1	Crystal Silver Night
001 SILPA	Crystal Silver Patina
001 SHPA	Crystal Silver Shade
001 SSHA	Crystal Silver Shade
001 TRA HFT	Crystal Transmission Hoelix Transparent
001 VOL	Crystal White Patina
202	Aquamarine
203	Topaz
204	Anethyl
205	Emerald
206	Sapphire
206 SAT	Sapphire Shine
207	Monara
208	Slam
209	Rose
211	Light Sapphire

CRYSTAL PATINA

001 L1065	Crystal Ivory Cream
001 L101	Crystal Powder Yellow
001 L103	Crystal Powder Rose
001 L1075	Crystal Royal Red
001 L1085	Crystal Dark Red
001 L104	Crystal Powder Blue
001 L1105	Crystal Royal Blue
001 L102	Crystal Powder Green
001 L1095	Crystal Royal Green
001 L1115	Crystal Dark Gray
001 WHIPA	Crystal White Patina
001 ROSPA	Crystal Rose Patina
001 SILPA	Crystal Silver Patina
001 GOLPA	Crystal Gold Patina
001 BLAPA	Crystal Blue Patina
001 L10H	Crystal Blue Shadow
001 PARSH	Crystal Paradise Shine
206 SAT	Sapphire Shine
001 BBL	Crystal Bermuda Blue
001 METBL	Crystal Metallic Blue
001 MBL	Crystal Meridian Blue
001 BLSH	Crystal Blue Shade
001 SCGR	Crystal Scabrous Green
001 RABDK	Crystal Rambow Dark
229 SAT	Blue Zircon Shine
213 AB	Jonquil Aurora Boreale
213 SA1	Jonquil Shine
315	Sunflower
204	Anethyl
277	Purple Velvet
369	Cobalt
286	Tanzanite
220	Smoked Topaz
286	Tanzanite
253	Grapehite
280	Jet
280 SIN1	Crystal Silver Night
280 NUT	Jet Nur
265	Crystal Silver Shade
283	Crystal Moonlight
268	Crystal Aurora Boreale

CRYSTAL PATINA

001 L1065	Crystal Ivory Cream
001 L101	Crystal Powder Yellow
001 L103	Crystal Powder Rose
001 L1075	Crystal Royal Red
001 L1085	Crystal Dark Red
001 L104	Crystal Powder Blue
001 L1105	Crystal Royal Blue
001 L102	Crystal Powder Green
001 L1095	Crystal Royal Green
001 L1115	Crystal Dark Gray
001 WHIPA	Crystal White Patina
001 ROSPA	Crystal Rose Patina
001 SILPA	Crystal Silver Patina
001 GOLPA	Crystal Gold Patina
001 BLAPA	Crystal Blue Patina
001 L10H	Crystal Blue Shadow
001 PARSH	Crystal Paradise Shine
206 SAT	Sapphire Shine
001 BBL	Crystal Bermuda Blue
001 METBL	Crystal Metallic Blue
001 MBL	Crystal Meridian Blue
001 BLSH	Crystal Blue Shade
001 SCGR	Crystal Scabrous Green
001 RABDK	Crystal Rambow Dark
229 SAT	Blue Zircon Shine
213 AB	Jonquil Aurora Boreale
213 SA1	Jonquil Shine
315	Sunflower
204	Anethyl
277	Purple Velvet
369	Cobalt
286	Tanzanite
220	Smoked Topaz
286	Tanzanite
253	Grapehite
280	Jet
280 SIN1	Crystal Silver Night
280 NUT	Jet Nur
265	Crystal Silver Shade
283	Crystal Moonlight
268	Crystal Aurora Boreale

CRYSTAL PATINA

001 L1065	Crystal Ivory Cream
001 L101	Crystal Powder Yellow
001 L103	Crystal Powder Rose
001 L1075	Crystal Royal Red
001 L1085	Crystal Dark Red
001 L104	Crystal Powder Blue
001 L1105	Crystal Royal Blue
001 L102	Crystal Powder Green
001 L1095	Crystal Royal Green
001 L1115	Crystal Dark Gray
001 WHIPA	Crystal White Patina
001 ROSPA	Crystal Rose Patina
001 SILPA	Crystal Silver Patina
001 GOLPA	Crystal Gold Patina
001 BLAPA	Crystal Blue Patina
001 L10H	Crystal Blue Shadow
001 PARSH	Crystal Paradise Shine
206 SAT	Sapphire Shine
001 BBL	Crystal Bermuda Blue
001 METBL	Crystal Metallic Blue
001 MBL	Crystal Meridian Blue
001 BLSH	Crystal Blue Shade
001 SCGR	Crystal Scabrous Green
001 RABDK	Crystal Rambow Dark
229 SAT	Blue Zircon Shine
213 AB	Jonquil Aurora Boreale
213 SA1	Jonquil Shine
315	Sunflower
204	Anethyl
277	Purple Velvet
369	Cobalt
286	Tanzanite
220	Smoked Topaz
286	Tanzanite
253	Grapehite
280	Jet
280 SIN1	Crystal Silver Night
280 NUT	Jet Nur
265	Crystal Silver Shade
283	Crystal Moonlight
268	Crystal Aurora Boreale

CRYSTAL PATINA

001 L1065	Crystal Ivory Cream
001 L101	Crystal Powder Yellow
001 L103	Crystal Powder Rose
001 L1075	Crystal Royal Red
001 L1085	Crystal Dark Red
001 L104	Crystal Powder Blue
001 L1105	Crystal Royal Blue
001 L102	Crystal Powder Green
001 L1095	Crystal Royal Green
001 L1115	Crystal Dark Gray
001 WHIPA	Crystal White Patina
001 ROSPA	Crystal Rose Patina
001 SILPA	Crystal Silver Patina
001 GOLPA	Crystal Gold Patina
001 BLAPA	Crystal Blue Patina
001 L10H	Crystal Blue Shadow
001 PARSH	Crystal Paradise Shine
206 SAT	Sapphire Shine
001 BBL	Crystal Bermuda Blue
001 METBL	Crystal Metallic Blue
001 MBL	Crystal Meridian Blue
001 BLSH	Crystal Blue Shade
001 SCGR	Crystal Scabrous Green
001 RABDK	Crystal Rambow Dark
229 SAT	Blue Zircon Shine
213 AB	Jonquil Aurora Boreale
213 SA1	Jonquil Shine
315	Sunflower
204	Anethyl
277	Purple Velvet
369	Cobalt
286	Tanzanite
220	Smoked Topaz
286	Tanzanite
253	Grapehite
280	Jet
280 SIN1	Crystal Silver Night
280 NUT	Jet Nur
265	Crystal Silver Shade
283	Crystal Moonlight
268	Crystal Aurora Boreale

CRYSTAL PATINA

001 L1065	Crystal Ivory Cream
001 L101	Crystal Powder Yellow
001 L103	Crystal Powder Rose
001 L1075	Crystal Royal Red
001 L1085	Crystal Dark Red
001 L104	Crystal Powder Blue
001 L1105	Crystal Royal Blue
001 L102	Crystal Powder Green
001 L1095	Crystal Royal Green
001 L1115	Crystal Dark Gray
001 WHIPA	Crystal White Patina
001 ROSPA	Crystal Rose Patina
001 SILPA	Crystal Silver Patina
001 GOLPA	Crystal Gold Patina
001 BLAPA	Crystal Blue Patina
001 L10H	Crystal Blue Shadow
001 PARSH	Crystal Paradise Shine
206 SAT	Sapphire Shine
001 BBL	Crystal Bermuda Blue
001 METBL	Crystal Metallic Blue
001 MBL	Crystal Meridian Blue
001 BLSH	Crystal Blue Shade
001 SCGR	Crystal Scabrous Green
001 RABDK	Crystal Rambow Dark
229 SAT	Blue Zircon Shine
213 AB	Jonquil Aurora Boreale
213 SA1	Jonquil Shine
315	Sunflower
204	Anethyl
277	Purple Velvet
369	Cobalt
286	Tanzanite
220	Smoked Topaz
286	Tanzanite
253	Grapehite
280	Jet
280 SIN1	Crystal Silver Night
280 NUT	Jet Nur
265	Crystal Silver Shade
283	Crystal Moonlight
268	Crystal Aurora Boreale





































































































CRYSTAL PATINA

001 L1065	Crystal Ivory Cream
001 L101	Crystal Powder Yellow
001 L103	Crystal Powder Rose
001 L1075	Crystal Royal Red
001 L1085	Crystal Dark Red
001 L104	Crystal Powder Blue
001 L1105	Crystal Royal Blue
001 L102	Crystal Powder Green
001 L1095	Crystal Royal Green
001 L1115	Crystal Dark Gray
001 WHIPA	Crystal White Patina
001 ROSPA	Crystal Rose Patina
001 SILPA	Crystal Silver Patina
001 GOLPA	Crystal Gold Patina
001 BLAPA	Crystal Blue Patina
001 L10H	Crystal Blue Shadow
001 PARSH	Crystal Paradise Shine
206 SAT	Sapphire Shine
001 BBL	Crystal Bermuda Blue
001 METBL	Crystal Metallic Blue
001 MBL	Crystal Meridian Blue
001 BLSH	Crystal Blue Shade
001 SCGR	Crystal Scabrous Green
001 RABDK	Crystal Rambow Dark
229 SAT	Blue Zircon Shine
213 AB	Jonquil Aurora Boreale
213 SA1	Jonquil Shine
315	Sunflower
204	Anethyl
277	Purple Velvet
369	Cobalt
286	Tanzanite
220	Smoked Topaz
286	Tanzanite
253	Grapehite
280	Jet
280 SIN1	



# FLAT BACKS HOTFIX

## SUMMARY

1 	2 	<b>2000 A HF</b> SS 3	1 	2 	<b>2483 M HF</b> 10 mm	1 	2 	<b>2728 M HF</b> SS 10, 16, 20, 34
		<b>2034 A HF</b> SS 10, 20, 48			<b>2493 M HF</b> 8, 10, 12 mm			<b>2738 M HF</b> 10x5, 12x6 mm
		<b>2035 M HF</b> 6, 10, 14 mm			<b>2494 M HF</b> 6, 8, 10.5 mm			<b>2739 M HF</b> 5.8x5.3, 7x6.5 mm
		<b>2037 M HF</b> 8, 14 mm			<b>2510 M HF</b> 5x2.5 mm			<b>2740 M HF</b> 8.3x8.3, 10x10 mm
		<b>2038 A HF</b> SS 5, 6, 8, 10			<b>2520 M HF</b> 8x6, 10x8 mm			<b>2753 M HF</b> 10, 14 mm
		<b>2078 A HF</b> SS 12, 16, 20, 30, 34, 40, 48			<b>2540 M HF</b> 7x5.5, 9x7, 12x9.5 mm			<b>2753/G M HF</b> 10, 14 mm
		<b>2078/G A HF</b> SS 20, 34			<b>2555 M HF</b> 8x2.6, 12x4, 15x5 mm			<b>2770 M HF</b> 6x3.5, 12x7 mm
		<b>2078/H A HF</b> SS 16, 20, 34			<b>2585 M HF</b> 8 mm			<b>2788 M HF</b> 8, 10 mm
		<b>2078/I A HF</b> SS 16, 20, 34			<b>2610 M HF</b> 6x4 mm			<b>DESIGNER EDITION</b> <b>2797 M HF</b> 8x4 mm
		<b>2080/4 HF</b> SS 10, 16, 34			<b>2611 M HF</b> 8, 10 mm			<b>2798 M HF</b> 8, 10, 14 mm
		<b>2080/H M HF</b> SS 34			<b>DESIGNER EDITION</b> <b>2612 M HF</b> 6, 10, 14 mm			<b>2808 M HF</b> 6, 10, 14 mm
		<b>2200 M HF</b> 8x4 mm			<b>2708 M HF</b> 8x8.7, 12.5x13.6 mm			<b>2813 M HF</b> 8x5.5, 10x7, 14x9.5 mm
		<b>2204 M HF</b> 6x4.8, 10x8, 14x11 mm			<b>2709 M HF</b> 10x6 mm			<b>2816 M HF</b> 5 mm
		<b>2205 M HF</b> 7.5, 10, 14 mm			<b>2711 M HF</b> 6 mm			<b>2817 M HF</b> 5 mm
		<b>2300 M HF</b> 8x4.8 mm			<b>2714 M HF</b> 6, 10, 14 mm			<b>2826 M HF</b> 5 mm
		<b>2304 M HF</b> 10x2.8, 14x3.9 mm			<b>2716 M HF</b> 5 mm			<b>2855 M HF</b> 8 mm
		<b>2400 M HF</b> 3, 4 mm			<b>2720 M HF</b> 7.5 mm			<b>2858 M HF</b> 6x4.5, 9x6.5, 12x8.5 mm

1 Top view 2 Side view

# FLAT BACKS HOTFIX

## 2000 Rose Hotfix

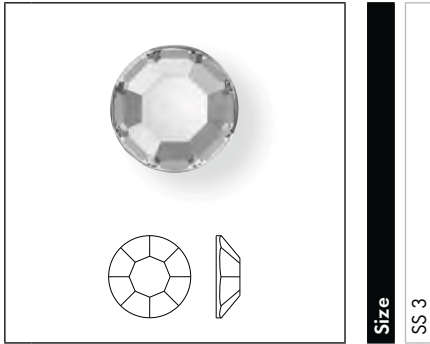

- Crystal**
- Crystal A HF (001)
- Colors**
- Plain Colors**
- Amethyst A HF (204)
- Aquamarine A HF (202)
- Black Diamond A HF (215)
- Jet A HF (280)
- Light Colorado Topaz A HF (246)
- Light Rose A HF (223)
- Montana A HF (207)
- Peridot A HF (214)
- Smoked Topaz A HF (220)
- Crystal Effects**
- Transparent Effects**
- Crystal AB A HF (001 AB)
- Crystal Golden Shadow A HF (001 GSHA)
- Crystal Silver Shade A HF (001 SSHA)
- Metallic Effects**
- Crystal Metallic Blue A HF (001 METBL)
- Crystal Metallic Light Gold A HF (001 MGLD)
- Crystal Rose Gold A HF (001 ROGL)
- Color Effects**
- Metallic Effects**
- Jet Hematite A HF (280 HEM)

## 2034 Concise Flat Back

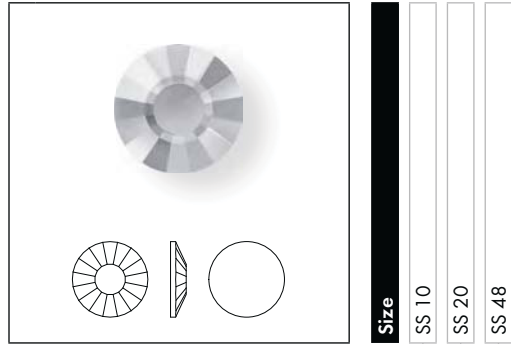

- Crystal**
- Crystal A HF (001)
- Colors**
- Plain Colors**
- Jet A HF (280)
- Light Siam A HF (227)
- Crystal Effects**
- Transparent Effects**
- Crystal AB A HF (001 AB)
- Crystal Golden Shadow A HF (001 GSHA)
- Metallic Effects**
- Crystal Light Chrome A HF (001 LTCH)
- Crystal Patina Effect**
- Crystal Black Patina A HF (001 BLAPA)
- Crystal Rose Patina A HF (001 ROSPA)
- Color Effects**
- Transparent Effects**
- Light Siam AB A HF (227 AB)

08 FLAT BACKS HOTFIX

# FLAT BACKS HOTFIX

## 2035 Chessboard Circle Flat Back

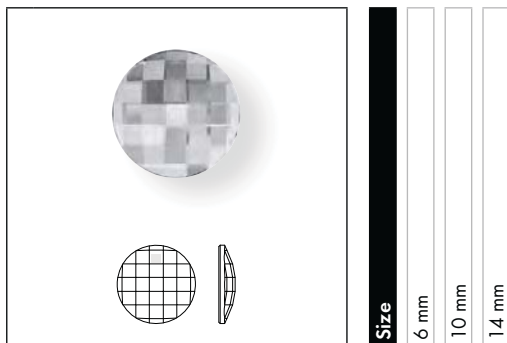

Size	6 mm	10 mm	14 mm
Crystal			
Crystal M HF (001)			
Colors			
Plain Colors			
Jet M HF (280)			
Crystal Effects			
Transparent Effects			
Crystal AB M HF (001 AB)			

### Crystal

Crystal M HF (001)

### Colors

#### Plain Colors

Jet M HF (280)

### Crystal Effects

#### Transparent Effects

Crystal AB M HF (001 AB)

## 2037 Eclipse Flat Back

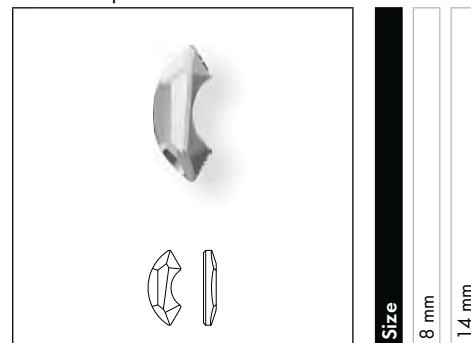

Size	8 mm	14 mm
Crystal		
Crystal M HF (001)		

### Crystal

Crystal M HF (001)



# FLAT BACKS HOTFIX

## 2038 XILION Rose Hotfix

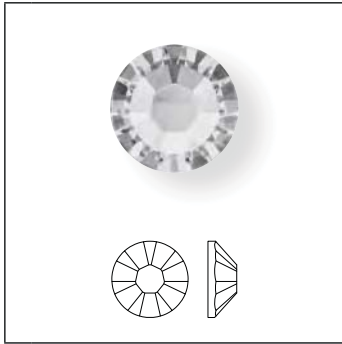

Size	SS 5	SS 6	SS 8	SS 10
------	------	------	------	-------

### Crystal

- Crystal A HF (001)
- Crystal Hotfix Transparent (001 HFT)

### Colors

#### Plain Colors

- Amethyst A HF (204)
- Aquamarine A HF (202)
- Black Diamond A HF (215)
- Blue Zircon A HF (229)
- Blush Rose A HF (257)
- Burgundy A HF (515)
- Capri Blue A HF (243)
- Chalkwhite A HF (279)
- Chrysolite A HF (238)
- Citrine A HF (249)
- Cobalt A HF (369)
- Dark Indigo A HF (288)
- Denim Blue A HF (266)
- Emerald A HF (205)
- Erinite A HF (360)
- Fern Green A HF (291)
- Fireopal A HF (237)
- Fuchsia A HF (502)
- Graphite A HF (253)
- Greige A HF (284)
- Hyacinth A HF (236)
- Indian Pink A HF (289)
- Indian Siam A HF (327)
- Jet A HF (280)
- Jonquil A HF (213)
- Khaki A HF (550)
- Light Amethyst A HF (212)
- Light Colorado Topaz A HF (246)
- Light Peach A HF (362)
- Light Rose A HF (223)
- Light Sapphire A HF (211)
- Light Siam A HF (227)
- Light Silk A HF (261)
- Light Topaz A HF (226)
- Light Turquoise A HF (263)
- Mocca A HF (286)
- Montana A HF (207)

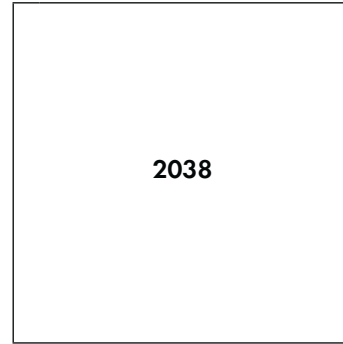

Size	SS 5	SS 6	SS 8	SS 10
------	------	------	------	-------

- Olivine A HF (228)
  - Padparadscha A HF (542)
  - Peridot A HF (214)
  - Provence Lavender A HF (283)
  - Purple Velvet A HF (277)
  - Rose A HF (209)
  - Rose Peach A HF (262)
  - Ruby A HF (501)
  - Sapphire A HF (206)
  - Siam A HF (208)
  - Silk A HF (391)
  - Smoked Topaz A HF (220)
  - Smoky Mauve A HF (265)
  - Sunflower A HF (292)
  - Tangerine A HF (259)
  - Tanzanite A HF (539)
  - Topaz A HF (203)
  - Vintage Rose A HF (319)
- ### Opal Colors
- Light Grey Opal A HF (383)
  - Pacific Opal A HF (390)
  - White Opal A HF (234)
  - Yellow Opal A HF (231)
- ### Crystal Effects
- #### Transparent Effects
- Crystal AB A HF (001 AB)
  - Crystal Antique Pink A HF (001 ANTP)
  - Crystal Blue Shade A HF (001 BLSH)
  - Crystal Bronze Shade A HF (001 BRSH)
  - Crystal Copper A HF (001 COP)
  - Crystal Cosmojet A HF (001 COS)
  - Crystal Golden Shadow A HF (001 GSHA)
  - Crystal Lilac Shadow A HF (001 LISH)
  - Crystal Luminous Green A HF (001 LJMG)
  - Crystal Meridian Blue A HF (001 MBL)
  - Crystal Moonlight A HF (001 MOL)
  - Crystal Paradise Shine A HF (001 PARSH)
  - Crystal Silver Night A HF (001 SINI)
  - Crystal Silver Shade A HF (001 SSHA)
  - Crystal Transmission HFT (001 TRA HFT)
  - Crystal Volcano A HF (001 VOL)

# FLAT BACKS HOTFIX

2038		Size	SS 5	SS 6	SS 8	SS 10
<b>Metallic Effects</b>						
	Crystal Dorado A HF (001 DOR)		■	■	■	■
	Crystal Iridescent Green A HF (001 IRIG)		■	■	■	■
	Crystal Light Chrome A HF (001 LTCH)		■	■	■	■
	Crystal Metallic Blue A HF (001 METBL)		■	■	■	■
	Crystal Metallic Light Gold A HF (001 MGLD)		■	■	■	■
	Crystal Metallic Sunshine A HF (001 METSH)		■	■	■	■
	Crystal Rainbow Dark A HF (001 RABDK)		■	■	■	■
	Crystal Rose Gold A HF (001 ROGL)		■	■	■	■
	Crystal Scarabaeus Green*** A HF (001 SCGR)		■	■	■	■
<b>Crystal Lacquer<sup>PRO</sup></b>						
	Crystal Powder Blue HFT (001 L104)					■
	Crystal Powder Green HFT (001 L102)					■
	Crystal Powder Rose HFT (001 L103)					■
	Crystal Powder Yellow HFT (001 L101)					■
	Crystal Dark Grey HFT (001 L111S)					■
	Crystal Dark Red HFT (001 L108S)					■
	Crystal Ivory Cream HFT (001 L106S)					■
	Crystal Royal Blue HFT (001 L110S)					■
	Crystal Royal Green HFT (001 L109S)					■
	Crystal Royal Red HFT (001 L107S)					■
<b>Color Effects</b>						
<b>Transparent Effects</b>						
	Blue Zircon Satin A HF (229 SAT)		■	■	■	■
	Jet AB A HF (280 AB)		■	■	■	■
	Jonquil AB A HF (213 AB)		■	■	■	■
	Jonquil Satin A HF (213 SAT)		■	■	■	■
	Light Rose AB A HF (223 AB)		■	■	■	■
	Light Siam AB A HF (227 AB)		■	■	■	■
	Light Siam Satin A HF (227 SAT)		■	■	■	■
	Sapphire Satin A HF (206 SAT)		■	■	■	■
<b>Metallic Effects</b>						
	Jet Hematite A HF (280 HEM)	■	■	■	■	■
	Jet Nut A HF (280 NUT)		■	■	■	■

\*\*\* designed by Jean Paul Gaultier

# FLAT BACKS HOTFIX

## 2078 XIRIUS Rose Hotfix



Size

SS 12

SS 16

SS 20

SS 30

SS 34

SS 40

SS 48

### Crystal

Crystal A HF (001)	■	■	■	■	■	■
Crystal Hotfix Transparent (001 HFT)		■				

### Colors

#### Plain Colors

Amethyst A HF (204)	■	■	■		■	
Aquamarine A HF (202)	■	■	■		■	
Black Diamond A HF (215)	■	■	■		■	
Blue Zircon A HF (229)	■	■	■		■	
Blush Rose A HF (257)	■	■	■		■	
Burgundy A HF (515)	■	■	■		■	
Capri Blue A HF (243)	■	■	■		■	
Chalkwhite A HF (279)	■	■	■		■	
Chrysolite A HF (238)	■	■	■		■	
Citrine A HF (249)	■	■	■		■	
Cobalt A HF (369)	■	■	■		■	
Dark Indigo A HF (288)	■	■	■		■	
Denim Blue A HF (266)	■	■	■		■	
Emerald A HF (205)	■	■	■		■	
Erinite A HF (360)	■	■	■		■	
Fern Green A HF (291)	■	■	■		■	
Fireopal A HF (237)	■	■	■		■	
Fuchsia A HF (502)	■	■	■		■	
Graphite A HF (253)	■	■	■		■	
Greige A HF (284)	■	■	■		■	
Hyacinth A HF (236)	■	■	■		■	
Indian Pink A HF (289)	■	■	■		■	
Indian Siam A HF (327)	■	■	■		■	
Jet A HF (280)	■	■	■	■	■	
Jonquil A HF (213)	■	■	■		■	
Khaki A HF (550)	■	■	■		■	
Light Amethyst A HF (212)	■	■	■		■	
Light Colorado Topaz A HF (246)	■	■	■		■	
Light Peach A HF (362)	■	■	■		■	
Light Rose A HF (223)	■	■	■		■	
Light Sapphire A HF (211)	■	■	■		■	
Light Siam A HF (227)	■	■	■	■	■	
Light Silk A HF (261)	■	■	■		■	
Light Topaz A HF (226)	■	■	■		■	
Light Turquoise A HF (263)	■	■	■		■	
Mocca A HF (286)	■	■	■		■	
Montana A HF (207)	■	■	■	■	■	

08 FLAT BACKS HOTFIX

# FLAT BACKS HOTFIX

2078		Size	SS 12	SS 16	SS 20	SS 30	SS 34	SS 40	SS 48
	Olivine A HF (228)		■	■	■		■		
	Padparadscha A HF (542)		■	■	■		■		
	Peridot A HF (214)		■	■	■		■		
	Provence Lavender A HF (283)		■	■	■		■		
	Purple Velvet A HF (277)		■	■	■		■		
	Rose A HF (209)		■	■	■		■		
	Rose Peach A HF (262)		■	■	■		■		
	Ruby A HF (501)		■	■	■		■		
	Sapphire A HF (206)		■	■	■		■		
	Siam A HF (208)		■	■	■		■		
	Silk A HF (391)		■	■	■		■		
	Smoked Topaz A HF (220)		■	■	■		■		
	Smoky Mauve A HF (265)		■	■	■		■		
	Sunflower A HF (292)		■	■	■		■		
	Tangerine A HF (259)		■	■	■		■		
	Tanzanite A HF (539)		■	■	■		■		
	Topaz A HF (203)		■	■	■		■		
	Vintage Rose A HF (319)		■	■	■		■		
<b>Opal Colors</b>									
	Light Grey Opal A HF (383)		■	■	■		■		
	Pacific Opal A HF (390)		■	■	■		■		
	White Opal A HF (234)		■	■	■		■		
	Yellow Opal A HF (231)		■	■	■		■		
<b>Crystal Effects</b>									
<b>Transparent Effects</b>									
	Crystal AB A HF (001 AB)		■	■	■	■	■	■	■
	Crystal Antique Pink A HF (001 ANTP)		■	■	■		■		
	Crystal Blue Shade A HF (001 BLSH)		■	■	■		■		
	Crystal Bronze Shade A HF (001 BRSH)		■	■	■		■		
	Crystal Copper A HF (001 COP)		■	■	■		■		
	Crystal Cosmojet A HF (001 COS)		■	■					
	Crystal Golden Shadow A HF (001 GSHA)		■	■	■	■	■		
	Crystal Lilac Shadow A HF (001 LISH)		■	■	■		■		
	Crystal Luminous Green A HF (001 LUMG)		■	■	■		■		
	Crystal Meridian Blue A HF (001 MBL)		■	■	■		■		
	Crystal Moonlight A HF (001 MOL)		■	■	■		■		
	Crystal Paradise Shine A HF (001 PARSH)		■	■	■		■		
	Crystal Silver Night A HF (001 SINI)		■	■	■		■		
	Crystal Silver Shade A HF (001 SSHA)		■	■	■		■		
	Crystal Transmission HFT (001 TRA HFT)		■	■	■		■		
	Crystal Volcano A HF (001 VOL)		■	■	■				

# FLAT BACKS HOTFIX

08 FLAT BACKS HOTFIX

2078		Size	SS 12	SS 16	SS 20	SS 30	SS 34	SS 40	SS 48
<b>Metallic Effects</b>									
	Crystal Dorado A HF (001 DOR)		■	■	■		■		
	Crystal Iridescent Green A HF (001 IRIG)		■	■	■		■		
	Crystal Light Chrome A HF (001 LTCH)		■	■	■		■		
	Crystal Metallic Blue A HF (001 METBL)		■	■	■		■		
	Crystal Metallic Light Gold A HF (001 MLGLD)		■	■	■		■		
	Crystal Metallic Sunshine A HF (001 METSH)		■	■	■		■		
	Crystal Rainbow Dark A HF (001 RABDK)		■	■	■		■		
	Crystal Rose Gold A HF (001 ROGL)		■	■	■		■		
	Crystal Scarabaeus Green***A HF (001 SCGR)		■	■	■		■		
<b>Crystal Lacquer<sup>PRO</sup></b>									
	Crystal Powder Blue HFT (001 L104)			■			■		
	Crystal Powder Green HFT (001 L102)			■			■		
	Crystal Powder Rose HFT (001 L103)			■			■		
	Crystal Powder Yellow HFT (001 L101)			■			■		
	Crystal Dark Grey HFT (001 L111S)			■			■		
	Crystal Dark Red HFT (001 L108S)			■			■		
	Crystal Ivory Cream HFT (001 L106S)			■			■		
	Crystal Royal Blue HFT (001 L110S)			■			■		
	Crystal Royal Green HFT (001 L109S)			■			■		
	Crystal Royal Red HFT (001 L107S)			■			■		
<b>Color Effects</b>									
<b>Transparent Effects</b>									
	Blue Zircon Satin A HF (229 SAT)		■	■	■		■		
	Jet AB A HF (280 AB)		■	■	■		■		
	Jonquil AB A HF (213 AB)		■	■	■		■		
	Jonquil Satin A HF (213 SAT)		■	■	■		■		
	Light Rose AB A HF (223 AB)		■	■	■		■		
	Light Siam AB A HF (227 AB)		■	■	■		■		
	Light Siam Satin A HF (227 SAT)		■	■	■		■		
	Sapphire Satin A HF (206 SAT)		■	■	■		■		
<b>Metallic Effects</b>									
	Jet Hematite A HF (280 HEM)		■	■	■	■	■		
	Jet Nut A HF (280 NUT)		■	■	■		■		

## 2078/G XIRIUS Rose partly frosted

2078/G XIRIUS Rose partly frosted		Size	SS 20	SS 34
<b>Crystal</b>				
	Crystal A HF (001)		■	■
<b>Colors</b>				
<b>Plain Colors</b>				
	Jet A HF (280)		■	■

\*\*\* designed by Jean Paul Gaultier

# FLAT BACKS HOTFIX

## FRAMED FLAT BACKS NEW SHAPES

### 2080/H Framed Cabochon



Size & color of ring
SS 34 gold (GR)
SS 34 silver (SR)
SS 34 gun metal (GM)

Colors
<b>Plain Colors</b>
● Jet M HF (280)
<b>Crystal Pearl Colors</b>
● Crystal Cream Pearl HF (001 291)
● Crystal White Pearl HF (001 650)
<b>Crystal Effects</b>
<b>Transparent Effects</b>
● Crystal Golden Shadow HF (001 GSHA)
● Crystal Nacre HF (001 191)
<b>Crystal Color Effects</b>
<b>Metallic Effects</b>
● Jet Hematite M HF (280 HEM)

■	■	■
■	■	■
■	■	■
■	■	■
■	■	■
■	■	■
■	■	■
■	■	■
■	■	■

FRAMED FLAT BACKS

The Framed Flat Backs present themselves as a highly upgraded version of ringed roses: They encase a XIRIUS crystal, the most brilliant crystal on the market, and the Cabochon, the non-sparkling version, with new metal

components in plating colors silver, gun metal, and gold. Both the plating quality and the glue applicability have been greatly improved.

2078/H Framed Flat Back

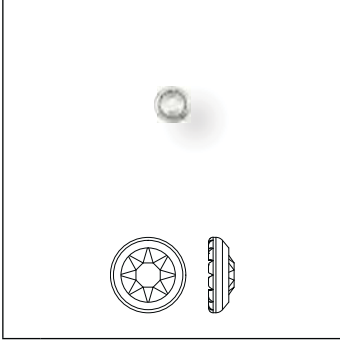

SS	SS 16	
M	1,440 PCS	100%

2078/H Framed Flat Back

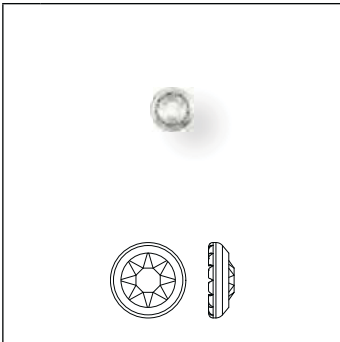

SS	SS 20	
M	1,440 PCS	100%

2078/H Framed Flat Back

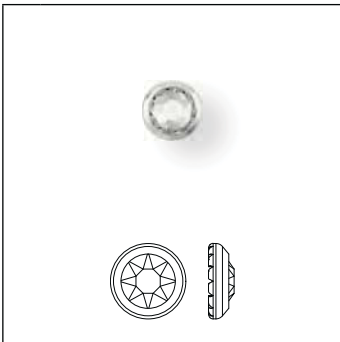

SS	SS 34	
M	144 PCS	100%

2078/H	<b>Size &amp; color of ring</b>	SS 16 Gold (GR)	SS 16 Silver (SR)	SS 16 Gun Metal (GM)	SS 20 Gold (GR)	SS 20 Silver (SR)	SS 20 Gun Metal (GM)	SS 34 Gold (GR)	SS 34 Silver (SR)	SS 34 Gun Metal (GM)
	<b>Crystal</b>	Crystal A HF (001)								
	<b>Colors</b>									
	<b>Plain Colors</b>									
	<b>Crystal Effects</b>									
	<b>Transparent Effects</b>									
	<b>Color Effects</b>									
	<b>Transparent Effects</b>									
		Crystal Golden Shadow A HF (001 GSHA)								
		Jet A HF (280)								
	Jet Hematite A HF (280 HEM)									





















# FLAT BACKS HOTFIX

## RIMMED FLAT BACK

While the partial metal coating of the Rimmed Flatback resonates with the desire for refined shine and lends itself perfectly to a modern puritan-inspired style, the dichotomy

of metal and crystal also meets the need to unify opposites, which elevates gender-fluid design directions to new heights.

### 2078/1 Rimmed Flat Back

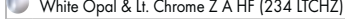
	Size	SS 16	SS 20	SS 34
	<b>Crystal Effects</b>			
	<b>Metallic Effects</b>			
	Crystal & Dorado Z AHF (001 DORZ)	■	■	■
	Crystal & Lt. Chrome Z A HF (001 LTCHZ)	■	■	■
	<b>Color Effects</b>			
	<b>Metallic Effects</b>			
	Black Diamond & Dorado Z A HF (215 DORZ)	■	■	■
	Black Diamond & Lt. Chrome Z A HF (215 LTCHZ)	■	■	■
	Burgundy & Dorado Z A HF (515 DORZ)	■	■	■
	Burgundy & Lt. Chrome Z A HF (515 LTCHZ)	■	■	■
	Denim Blue & Dorado Z A HF (266 DORZ)	■	■	■
	Denim Blue & Lt. Chrome Z A HF (266 LTCHZ)	■	■	■
	Greige & Dorado Z A HF (284 DORZ)	■	■	■
	Greige & Lt. Chrome Z A HF (284 LTCHZ)	■	■	■
	Jet & Dorado Z A HF (280 DORZ)	■	■	■
	Jet & Lt. Chrome Z A HF (280 LTCHZ)	■	■	■
	Khaki & Dorado Z A HF (550 DORZ)	■	■	■
	Khaki & Lt. Chrome Z A HF (550 LTCHZ)	■	■	■
	Light Siam & Dorado Z A HF (227 DORZ)	■	■	■
	Light Siam & Lt. Chrome Z A HF (227 LTCHZ)	■	■	■
	White Opal & Dorado Z A HF (234 DORZ)	■	■	■
	White Opal & Lt. Chrome Z A HF (234 LTCHZ)	■	■	■



FLAT BACKS HOTFIX

2080/4 Cabochon

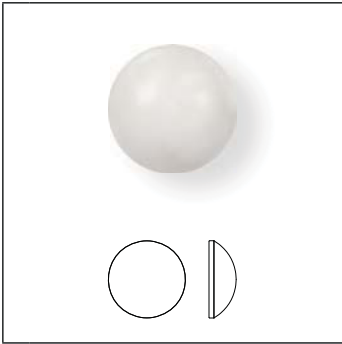

<b>Size</b>	SS 10	SS 16	SS 34
-------------	-------	-------	-------

- Colors**
- Plain Colors**
- Jet M HF (280)
- Crystal Pearl Colors**
- Crystal Bronze Pearl HF (001 295)
- Crystal Creampearl HF (001 291)
- Crystal Dark Grey Pearl HF (001 617)
- Crystal Light Grey Pearl HF (001 616)
- Crystal Rosaline Pearl HF (001 294)
- Crystal White Pearl HF (001 650)
- Crystal Effects**
- Transparent Effects**
- Crystal Golden Shadow HF (001 GSHA)
- Crystal Nacre HF (001 191)
- Metallic Effects**
- Crystal Light Chrome HF (001 LTCH)
- Crystal Scarabaeus Green\*\*\*HF (001 SCGR)
- Crystal Lacquer<sup>PRO</sup>**
- Crystal Powder Blue HFT (001 L104)
- Crystal Powder Green HFT (001 L102)
- Crystal Powder Rose HFT (001 L103)
- Crystal Color Effects**
- Metallic Effects**
- Jet Hematite M HF (280 HEM)

2200 Navette Flat Back

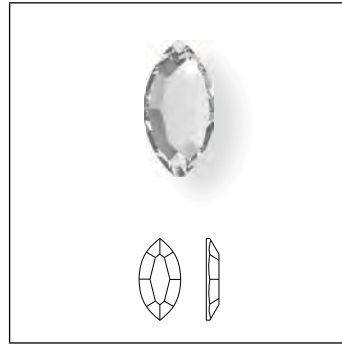

<b>Size</b>	8x4 mm
-------------	--------

- Crystal**
- Crystal M HF (001)
- Colors**
- Plain Colors**
- Jet M HF (280)
- Crystal Effects**
- Transparent Effects**
- Crystal AB M HF (001 AB)
- Crystal Golden Shadow M HF (001 GSHA)
- Crystal Silver Shade M HF (001 SSHA)
- Crystal Color Effects**
- Metallic Effects**
- Jet Hematite M HF (280 HEM)

2204 Pure Leaf Flat Back

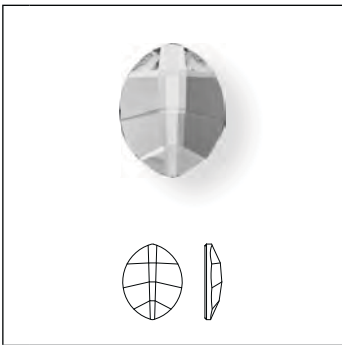

<b>Size</b>	6x4.8 mm	10x8 mm	14x11 mm
-------------	----------	---------	----------

- Crystal**
- Crystal M HF (001)

\*\*\* designed by Jean Paul Gaulier

# FLAT BACKS HOTFIX

## 2205 Flame Flat Back

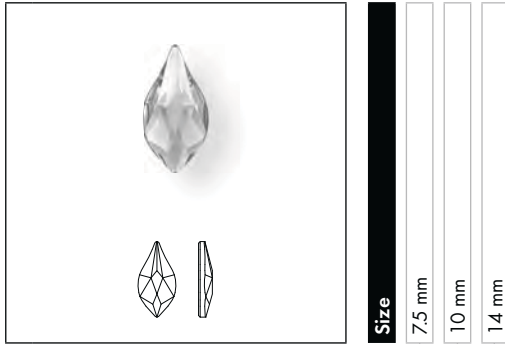

**Size**  
7.5 mm  
10 mm  
14 mm

### Crystal

Crystal M HF (001)

### Colors

#### Plain Colors

Fireopal M HF (237)

Jet M HF (280)

Light Colorado Topaz M HF (246)

Light Siam M HF (227)

#### Opal Colors

White Opal M HF (234)

### Crystal Effects

#### Transparent Effects

Crystal AB M HF (001 AB)

Crystal Golden Shadow M HF (001 GSHA)

Crystal Silver Night M HF (001 SINI)

#### Metallic Effects

Crystal Iridescent Green M HF (001 IRIG)

## 2300 Drop Flat Back



**Size**  
8x4.8 mm

### Crystal

Crystal M HF (001)

### Colors

#### Plain Colors

Jet M HF (280)

### Crystal Effects

#### Transparent Effects

Crystal AB M HF (001 AB)

Crystal Golden Shadow M HF (001 GSHA)

#### Metallic Effects

Crystal Light Chrome M HF (001 LTCH)

### Color Effects

#### Metallic Effects

Jet Hematite M HF (280 HEM)

FLAT BACKS HOTFIX

2304 Raindrop Flat Back

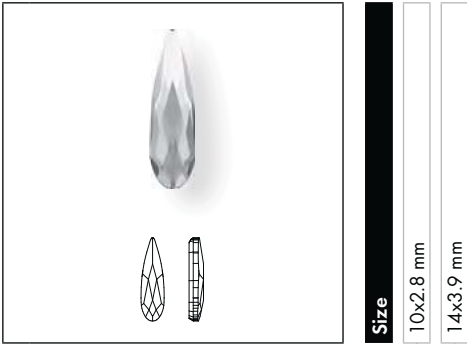

Size  
10x2.8 mm  
14x3.9 mm

- Crystal**
- Crystal M HF (001)
- Colors**
- Plain Colors**
- Blush Rose M HF (257)
- Jet M HF (280)
- Light Siam M HF (227)
- Crystal Effects**
- Transparent Effects**
- Crystal AB M HF (001 AB)
- Crystal Blue Shade M HF (001 BLSH)
- Crystal Golden Shadow M HF (001 GSHA)
- Crystal Luminous Green M HF (001 LUMG)
- Crystal Silver Night M HF (001 SINI)

2400 Square Flat Back

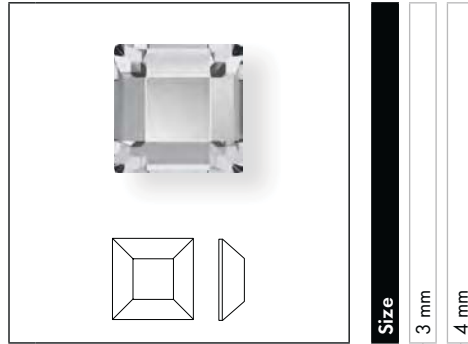

Size  
3 mm  
4 mm

- Crystal**
- Crystal M HF (001)
- Colors**
- Plain Colors**
- Graphite M HF (253)
- Jet M HF (280)
- Crystal Effects**
- Transparent Effects**
- Crystal AB M HF (001 AB)
- Crystal Golden Shadow M HF (001 GSHA)
- Metallic Effects**
- Crystal Light Chrome M HF (001 LTCH)
- Color Effects**
- Metallic Effects**
- Jet Hematite M HF (280 HEM)

2483 Classic Square Flat Back

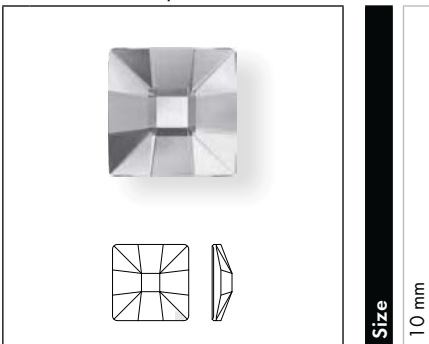

Size  
10 mm

- Crystal**
- Crystal M HF (001)
- Colors**
- Plain Colors**
- Black Diamond M HF (215)
- Crystal Effects**
- Transparent Effects**
- Crystal Golden Shadow M HF (001 GSHA)

2493 Chessboard Flat Back

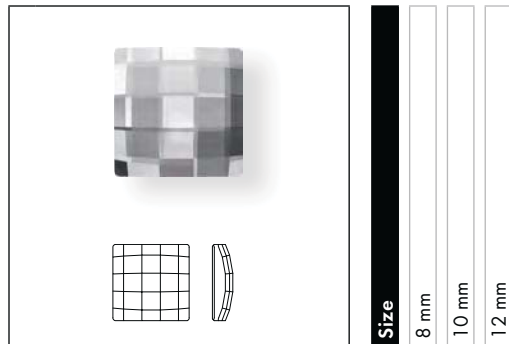

Size  
8 mm  
10 mm  
12 mm

- Crystal**
- Crystal M HF (001)
- Crystal Effects**
- Crystal AB M HF (001 AB)
- Crystal Patina Effect**
- Crystal Black Patina M HF (001 BLAPA)
- Crystal Gold Patina M HF (001 GOLPA)
- Crystal Rose Patina M HF (001 ROSPA)
- Crystal Silver Patina M HF (001 SILPA)
- Crystal White Patina M HF (001 WHIPA)

# FLAT BACKS HOTFIX

## 2494 Starlet Flat Back



**Size**  
6 mm  
8 mm  
10.5 mm

### Crystal

Crystal M HF (001)

### Colors

#### Plain Colors

Jet M HF (280)

Light Siam M HF (227)

Light Turquoise M HF (263)

Smoky Mauve M HF (265)

### Crystal Effects

#### Transparent Effects

Crystal AB M HF (001 AB)

Crystal Bermuda Blue M HF (001 BBL)

Crystal Golden Shadow M HF (001 GSHA)

Crystal Luminous Green M HF (001 LUMG)

Crystal Paradise Shine M HF (001 PARSH)

Crystal Silver Night M HF (001 SINI)

## 2510 Baguette Flat Back

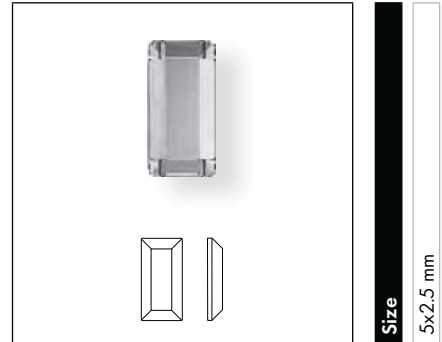

**Size**  
5x2.5 mm

### Crystal

Crystal M HF (001)

### Colors

#### Plain Colors

Jet M HF (280)

### Crystal Effects

#### Transparent Effects

Crystal AB M HF (001 AB)

### Metallic Effects

Crystal Light Chrome M HF (001 LTCH)

### Color Effects

#### Metallic Effects

Jet Hematite M HF (280 HEM)

## 2520 Cosmic Flat Back



**Size**  
8x6 mm  
10x8 mm

### Crystal

Crystal M HF (001)

FLAT BACKS HOTFIX

2540 Curvy Flat Back

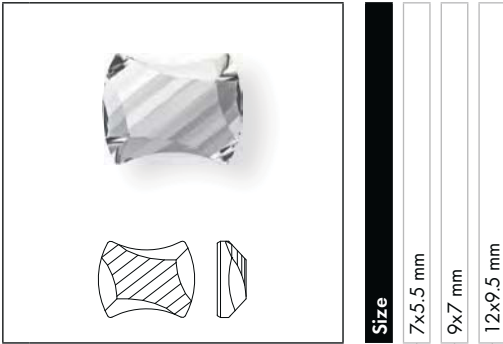

**Size**  
7x5.5 mm  
9x7 mm  
12x9.5 mm

Crystal	
Crystal M HF (001)	■ ■ ■
Colors	
Plain Colors	
Jet M HF (280)	■ ■ ■
Light Siam M HF (227)	■ ■ ■
Light Turquoise M HF (263)	■ ■ ■
Smoky Mauve M HF (265)	■ ■ ■
Rose Peach M HF (262)	■ ■ ■
Crystal Effects	
Transparent Effects	
Crystal AB M HF (001 AB)	■ ■ ■
Crystal Bermuda Blue M HF (001 BBL)	■ ■ ■
Crystal Golden Shadow M HF (001 GSHA)	■ ■ ■
Crystal Luminous Green M HF (001 LUMG)	■ ■ ■
Crystal Paradise Shine M HF (001 PARSH)	■ ■ ■
Crystal Silver Night M HF (001 SINI)	■ ■ ■

2555 Cosmic Baguette Flat Back

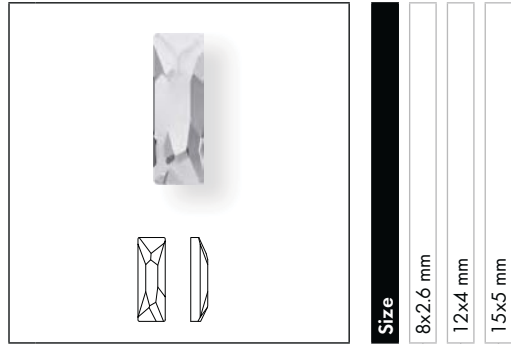

**Size**  
8x2.6 mm  
12x4 mm  
15x5 mm

Crystal	
Crystal M HF (001)	■ ■ ■
Colors	
Plain Colors	
Jet M HF (280)	■ ■ ■
Crystal Effects	
Transparent Effects	
Crystal AB M HF (001 AB)	■ ■ ■
Crystal Golden Shadow M HF (001 GSHA)	■ ■ ■
Crystal Silver Shade M HF (001 SSHA)	■ ■ ■

2585 Graphic Flat Back



**Size**  
8 mm

Crystal	
Crystal M HF (001)	■

2610 Rectangle Flat Back

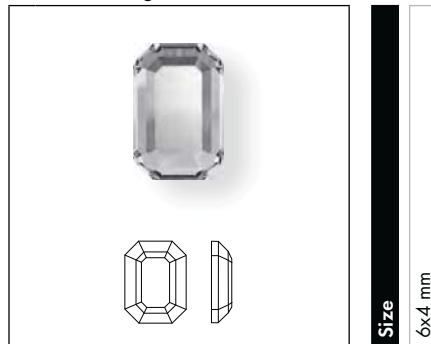

**Size**  
6x4 mm

Crystal	
Crystal M HF (001)	■

# FLAT BACKS HOTFIX

## 2611 Solaris Flat Back

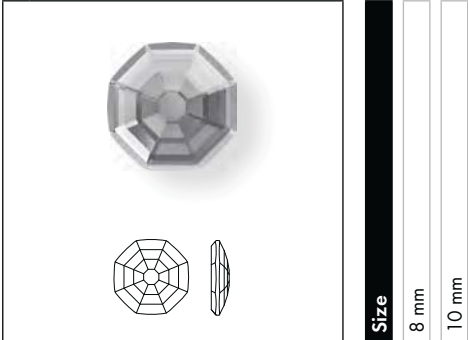

**Crystal**

Crystal M HF (001)

**Colors**

**Plain Colors**

Jet M HF (280)

**Crystal Effects**

**Transparent Effects**

Crystal AB M HF (001 AB)

Crystal Golden Shadow M HF (001 GSHA)

Crystal Silver Night M HF (001 SINI)

OCEAN MYSTERIES DESIGNED  
BY CÉLINE COUSTEAU

**Design Story:** A love for the sea runs through her veins: Céline Cousteau is a celebrated filmmaker, humanitarian, and environmentalist, and, as it so happens, the granddaughter of legendary ocean explorer Jacques Yves Cousteau. She presents her first ever crystal designs for Swarovski, inspired by one of her favorite places, the depths of the ocean. Taking inspiration from nature itself

and leaving its beauty unaltered, her stunningly life-like creatures are not only captivating and spellbinding, they also draw attention toward the mysterious, mostly unseen, and unexplored world beneath the ocean's surface on which all ocean life depends. These mysteries need to be protected for future generations, both above and below the water.

08 FLAT BACKS HOTFIX

2612 Jelly Fish Flat Back partly frosted Hotfix

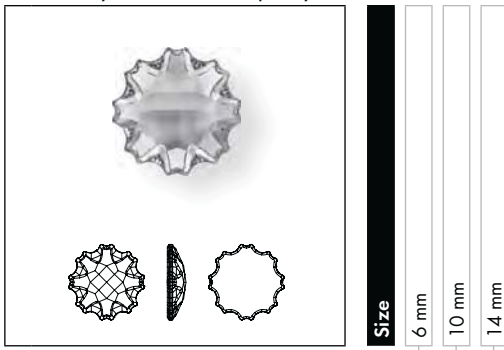

	6 mm	10 mm	14 mm
<b>Crystal</b>			
Crystal M HF (001)	■	■	■
<b>Colors</b>			
<b>Plain Colors</b>			
Blush Rose M HF (257)	■	■	■
Jet M HF (280)	■	■	■
Tanzanite M HF (539)	■	■	■
<b>Opal Colors</b>			
White Opal M HF (234)	■	■	■
<b>Crystal Effects</b>			
<b>Transparent Effects</b>			
Crystal AB M HF (001 AB)	■	■	■
Crystal Bermuda Blue M HF (001 BBL)	■	■	■
Crystal Blue Shade M HF (001 BLSH)	■	■	■
Crystal Golden Shadow M HF (001 GSHA)	■	■	■
Crystal Luminous Green M HF (001 LUMG)	■	■	■
Crystal Silver Night M HF (001 SINI)	■	■	■

# FLAT BACKS HOTFIX

## THE CÉLINE COUSTEAU DESIGNER EDITION FAMILY



**1695** chapter 01 Round Stones  
10, 14 mm p. 86



**1695/S** chapter 01 Round Stones  
10, 14 mm p. 86



**2612** chapter 07 Flat Backs No Hotfix  
6, 10, 14 mm p. 360



**2612** chapter 08 Flat Backs Hotfix  
6, 10, 14 mm p. 396



**4195** chapter 02 Fancy Stones & Settings  
14, 18, 22 mm p. 103



**4195/S** chapter 02 Fancy Stones & Settings  
14, 18, 22 mm p. 103



**6730** chapter 06 Pendants  
18x11.5, 34x22 mm p. 321



**6731** chapter 06 Pendants  
14, 28 mm p. 322

## DESIGNER EDITIONS - DISTINCT PACKAGING

This Designer Edition will be labelled with the  
"Designer Edition" imprint directly on the packaging.



FLAT BACKS HOTFIX

2708 Molecule Flat Back

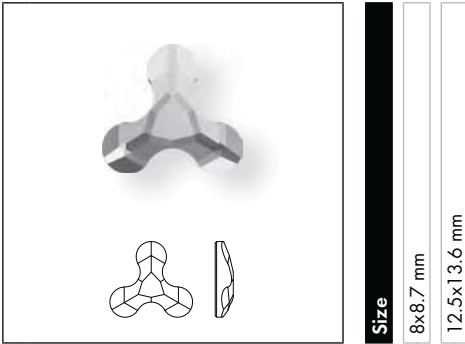

Size  
8x8.7 mm  
12.5x13.6 mm

- Crystal**
- Crystal M HF (001)
- Crystal Effects**
- Transparent Effects**
- Crystal AB M HF (001 AB)

2709 Rhombus Flat Back

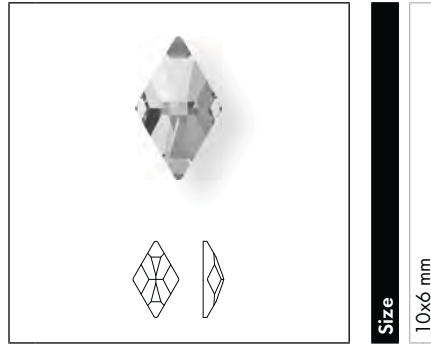

Size  
10x6 mm

- Crystal**
- Crystal M HF (001)
- Colors**
- Plain Colors**
- Black Diamond M HF (215)
- Light Siam M HF (227)
- Crystal Effects**
- Transparent Effects**
- Crystal AB M HF (001 AB)
- Crystal Golden Shadow M HF (001 GSHA)

2711 Triangle Flat Back

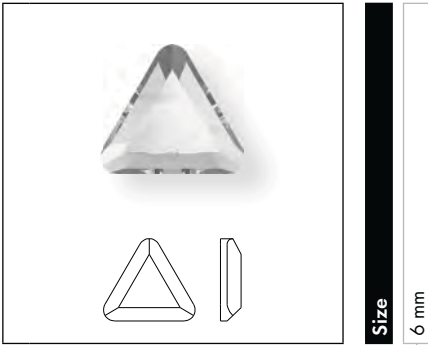

Size  
6 mm

- Crystal**
- Crystal M HF (001)
- Colors**
- Plain Colors**
- Jet M HF (280)
- Crystal Effects**
- Transparent Effects**
- Crystal AB M HF (001 AB)
- Color Effects**
- Metallic Effects**
- Jet Hematite M HF (280 HEM)

2714 Fan Flat Back Hotfix

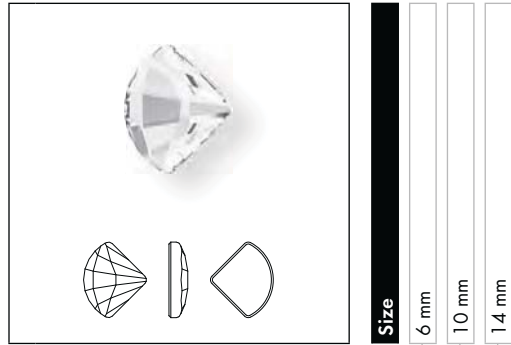

Size  
6 mm  
10 mm  
14 mm

- Crystal**
- Crystal M HF (001)
- Colors**
- Plain Colors**
- Blush Rose M HF (257)
- Jet M HF (280)
- Jonquil M HF (213)
- Light Siam M HF (227)
- Rose Peach M HF (262)
- Crystal Effects**
- Transparent Effects**
- Crystal AB M HF (001 AB)
- Crystal Blue Shade M HF (001 BLSH)
- Crystal Golden Shadow M HF (001 GSHA)
- Crystal Silver Night M HF (001 SINI)
- Metallic Effects**
- Crystal Metallic Sunshine M HF (001 METSH)
- Crystal Scarabaeus Green\*\*\*M HF (001 SCGR)

\*\*\* designed by Jean Paul Gaultier

# FLAT BACKS HOTFIX

**2716** Rivoli Triangle Flat Back

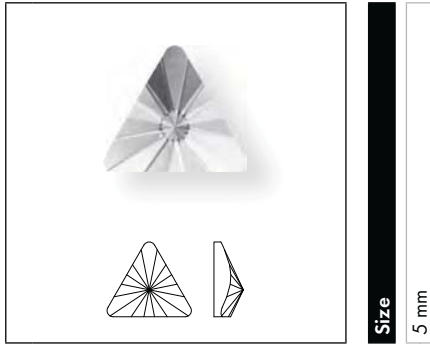

**Size**  
5 mm

**Crystal**

Crystal M HF (001)

**Crystal Effects**

**Transparent Effects**

Crystal AB M HF (001 AB)

**2720** Cosmic Delta Flat Back

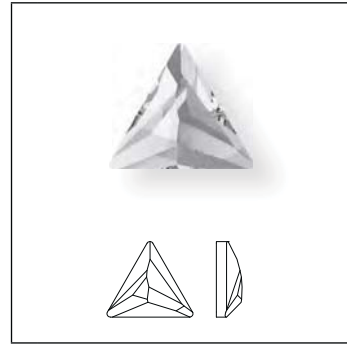

**Size**  
7.5 mm

**Crystal**

Crystal M HF (001)

**Colors**

**Plain Colors**

Jet M HF (280)

**Crystal Effects**

**Transparent Effects**

Crystal AB M HF (001 AB)

**2728** Marguerite Flat Back

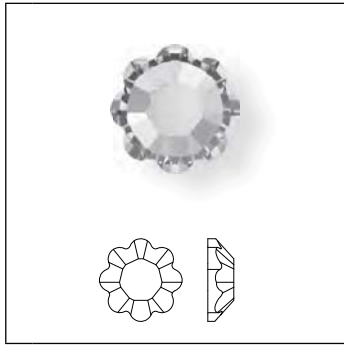

**Size**  
SS 10  
SS 16  
SS 20  
SS 34

**Crystal**

Crystal M HF (001)

**Crystal Effects**

**Transparent Effects**

Crystal AB M HF (001 AB)

# FLAT BACKS HOTFIX

## 2738 Triangle Alpha Flat Back

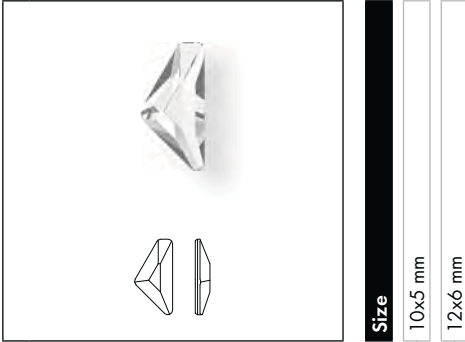

Size

10x5 mm

12x6 mm

**Crystal**

Crystal M HF (001)

**Colors**

**Plain Colors**

Blush Rose M HF (257)

Jet M HF (280)

Light Colorado Topaz M HF (246)

Light Sapphire M HF (211)

Light Siam M HF (227)

**Crystal Effects**

**Transparent Effects**

Crystal AB M HF (001 AB)

Crystal Golden Shadow M HF (001 GSHA)

Crystal Silver Night M HF (001 SINI)

**Crystal Lacquer<sup>PRO</sup>**

Crystal Dark Grey HFT (001 L111S)

Crystal Dark Red HFT (001 L108S)

Crystal Ivory Cream HFT (001 L106S)

## 2739 Triangle Beta Flat Back

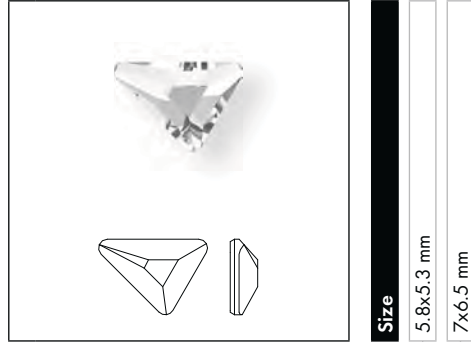

Size

5.8x5.3 mm

7x6.5 mm

**Crystal**

Crystal M HF (001)

**Colors**

**Plain Colors**

Blush Rose M HF (257)

Jet M HF (280)

Light Colorado Topaz M HF (246)

Light Sapphire M HF (211)

Light Siam M HF (227)

**Crystal Effects**

**Transparent Effects**

Crystal AB M HF (001 AB)

Crystal Golden Shadow M HF (001 GSHA)

Crystal Silver Night M HF (001 SINI)

**Crystal Lacquer<sup>PRO</sup>**

Crystal Dark Grey HFT (001 L111S)

Crystal Dark Red HFT (001 L108S)

Crystal Ivory Cream HFT (001 L106S)

# FLAT BACKS HOTFIX

## 2740 Triangle Gamma Flat Back

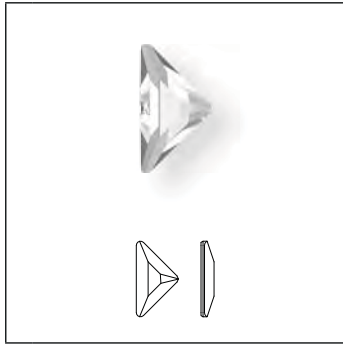

**Size**

8.3x8.3 mm

10x10 mm

### Crystal

Crystal M HF (001)

### Colors

#### Plain Colors

Blush Rose M HF (257)

Jet M HF (280)

Light Colorado Topaz M HF (246)

Light Sapphire M HF (211)

Light Siam M HF (227)

### Crystal Effects

#### Transparent Effects

Crystal AB M HF (001 AB)

Crystal Golden Shadow M HF (001 GSHA)

Crystal Silver Night M HF (001 SINI)

### Crystal Lacquer<sup>PRO</sup>

Crystal Dark Grey HFT (001 L111S)

Crystal Dark Red HFT (001 L108S)

Crystal Ivory Cream HFT (001 L106S)

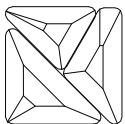

Alpha, Beta & Gamma FBs  
create together a square.

FLAT BACKS HOTFIX

2753 Edelweiss Flat Back

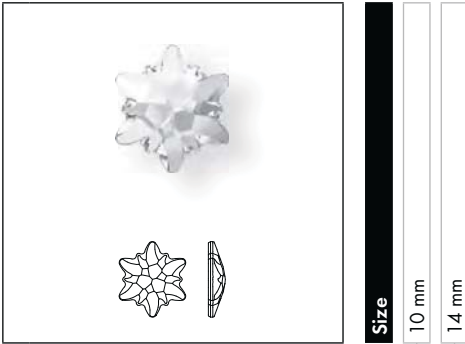

Size  
10 mm  
14 mm

- Crystal**
- Crystal M HF (001)
- Colors**
- Plain Colors**
- Amethyst M HF (204)
- Denim Blue M HF (266)
- Light Siam M HF (227)
- Vintage Rose M HF (319)
- Opal Colors**
- White Opal M HF (234)
- Crystal Effects**
- Transparent Effects**
- Crystal AB M HF (001 AB)
- Crystal Blue Shade M HF (001 BLSH)
- Crystal Golden Shadow M HF (001 GSHA)
- Crystal Luminous Green M HF (001 LUMG)
- Crystal Silver Night M HF (001 SINI)
- Metallic Effects**
- Crystal Metallic Sunshine M HF (001 METSH)

2753/G Edelweiss Flat Back partly frosted



Size  
10 mm  
14 mm

- Crystal**
- Crystal M HF (001)
- Crystal Effects**
- Transparent Effects**
- Crystal AB M HF (001 AB)
- Crystal Blue Shade M HF (001 BLSH)
- Crystal Golden Shadow M HF (001 GSHA)
- Crystal Luminous Green M HF (001 LUMG)
- Crystal Silver Night M HF (001 SINI)
- Metallic Effects**
- Crystal Metallic Sunshine M HF (001 METSH)

2770 Wing Flat Back

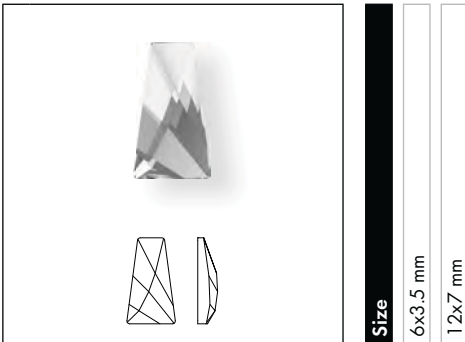

Size  
6x3.5 mm  
12x7 mm

- Crystal**
- Crystal M HF (001)
- Crystal Effects**
- Transparent Effects**
- Crystal AB M HF (001 AB)

2788 Wave Flat Back



Size  
8 mm  
10 mm

- Crystal**
- Crystal M HF (001)
- Crystal Effects**
- Transparent Effects**
- Crystal AB M HF (001 AB)

DIAMOND LEAF<sup>1</sup>



Swarovski and Giorgio Armani worked together to create an exclusive crystal called “Diamond Leaf”. This Designer Edition has a fluid, organic shape reminiscent of a leaf. Precision cut facets melt into the softness of a floating, sculptural form, contrasting strength and fragility, the timeless with the ethereal.

**Giorgio Armani: “Swarovski crystal brings a touch of magic to a dress, an ethereal quality, a lustre which never fails to captivate the attention.”**

2797 Diamond Leaf Flat Back<sup>1</sup>



THE DIAMOND LEAF DESIGNER EDITION FAMILY

- 
**2797** 8x4, 10x5 mm chapter 07 Flat Back No Hotfix p. 367
- 
**2797** 8x4 mm chapter 08 Flat Back Hotfix p. 403
- 
**3254** 20x9, 30x14 mm chapter 09 Sew-on Articles p. 421

DESIGNER EDITIONS - DISTINCT PACKAGING

This Designer Edition will be labelled with the “Designer Edition” imprint directly on the packaging.

<sup>1</sup> Article consists of Advanced Crystal

# FLAT BACKS HOTFIX

## 2798 Contour Flat Back

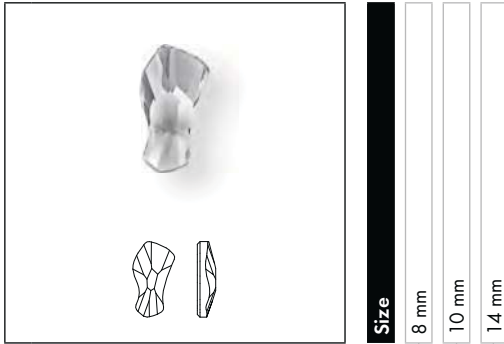

**Size**  
8 mm  
10 mm  
14 mm

Crystal		
Crystal M HF (001)	■	■
Colors		
Plain Colors		
Graphite M HF (253)	■	■
Jet M HF (280)	■	■
Light Colorado Topaz M HF (246)	■	■
Light Silk M HF (261)	■	■
Opal Colors		
Light Grey Opal M HF (383)	■	■
White Opal M HF (234)	■	■
Crystal Effects		
Transparent Effects		
Crystal AB M HF (001 AB)	■	■
Crystal Blue Shade M HF (001 BLSH)	■	■
Crystal Golden Shadow M HF (001 GSHA)	■	■
Crystal Silver Night M HF (001 SINI)	■	■
Metallic Effects		
Crystal Iridescent Green M HF (001 IRIG)	■	■

## 2808 Heart Flat Back

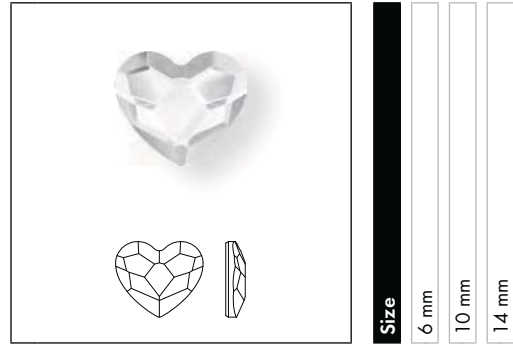

**Size**  
6 mm  
10 mm  
14 mm

Crystal		
Crystal M HF (001)	■	■
Colors		
Plain Colors		
Denim Blue M HF (266)	■	■
Fuchsia M HF (502)	■	■
Jet M HF (280)	■	■
Light Siam M HF (227)	■	■
Crystal Effects		
Transparent Effects		
Crystal AB M HF (001 AB)	■	■
Crystal Golden Shadow M HF (001 GSHA)	■	■
Crystal Lacquer <sup>PRO</sup>		
Crystal Powder Blue HFT (001 L104)	■	■
Crystal Powder Green HFT (001 L102)	■	■
Crystal Powder Rose HFT (001 L103)	■	■
Crystal Patina Effect		
Crystal Black Patina M HF (001 BLAPA)	■	■
Crystal Gold Patina M HF (001 GOLPA)	■	■
Crystal Rose Patina M HF (001 ROSPA)	■	■
Crystal Silver Patina M HF (001 SILPA)	■	■
Crystal White Patina M HF (001 WHIPA)	■	■

# FLAT BACKS HOTFIX

## 2813 Moon Flat Back Hotfix

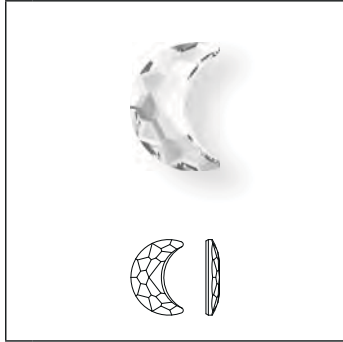

Size	8x5.5 mm	10x7 mm	14x9.5 mm
------	----------	---------	-----------

### Crystal

Crystal M HF (001)	■	■	■
--------------------	---	---	---

### Colors

#### Plain Colors

Blush Rose M HF (257)	■	■	■
Jet M HF (280)	■	■	■
Light Colorado Topaz M HF (246)	■	■	■
Light Siam M HF (227)	■	■	■

### Crystal Effects

#### Transparent Effects

Crystal AB M HF (001 AB)	■	■	■
Crystal Golden Shadow M HF (001 GSHA)	■	■	■
Crystal Luminous Green M HF (001 LUMG)	■	■	■
Crystal Moonlight M HF (001 MOL)	■	■	■
Crystal Silver Night M HF (001 SINI)	■	■	■

### Crystal Effects

#### Metallic Effects

Crystal Metallic Sunshine M HF (001 METSH)	■	■	■
Crystal Scarabaeus Green ***M HF (001 SCGR)	■	■	■

## 2816 Rivoli Star Flat Back

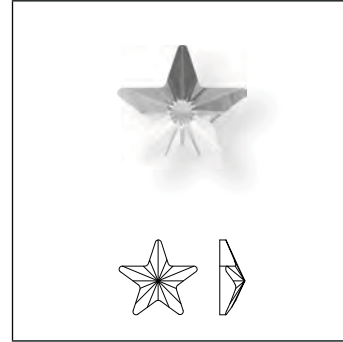

Size	5 mm
------	------

### Crystal

Crystal M HF (001)	■
--------------------	---

### Colors

#### Plain Colors

Jet M HF (280)	■
----------------	---

### Crystal Effects

#### Transparent Effects

Crystal AB M HF (001 AB)	■
--------------------------	---

### Color Effects

#### Metallic Effects

Jet Hematite M HF (280 HEM)	■
-----------------------------	---



FLAT BACKS HOTFIX

2817 Star Flat Back

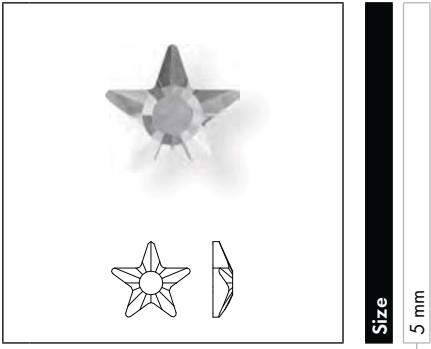

Size  
5 mm

- Crystal**
- Crystal M HF (001)
- Colors**
- Plain Colors**
- Jet M HF (280)
- Crystal Effects**
- Transparent Effects**
- Crystal AB M HF (001 AB)
- Crystal Golden Shadow M HF (001 GSHA)
- Crystal Silver Night M HF (001 SINI)
- Color Effects**
- Metallic Effects**
- Jet Hematite M HF (280 HEM)

2826 Rivoli Snowflake Flat Back

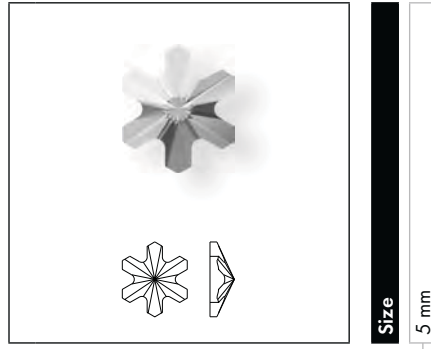

Size  
5 mm

- Crystal**
- Crystal M HF (001)
- Crystal Effects**
- Transparent Effects**
- Crystal AB M HF (001 AB)

2855 Butterfly Flat Back

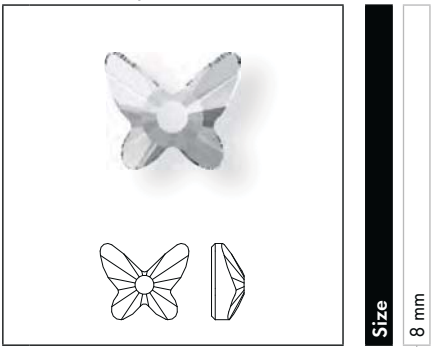

Size  
8 mm

- Crystal**
- Crystal M HF (001)
- Colors**
- Plain Colors**
- Denim Blue M HF (266)
- Jet M HF (280)
- Crystal Effects**
- Transparent Effects**
- Crystal AB M HF (001 AB)
- Crystal Golden Shadow M HF (001 GSHA)
- Crystal Silver Night M HF (001 SINI)

2858 Bow Tie Flat Back

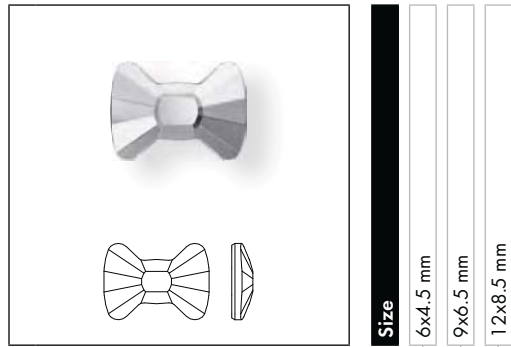

Size  
6x4.5 mm  
9x6.5 mm  
12x8.5 mm

- Crystal**
- Crystal M HF (001)
- Colors**
- Plain Colors**
- Jet M HF (280)
- Crystal Effects**
- Transparent Effects**
- Crystal AB M HF (001 AB)
- Crystal Golden Shadow M HF (001 GSHA)
- Crystal Luminous Green M HF (001 LUMG)
- Crystal Paradise Shine M HF (001 PARSH)
- Crystal Silver Night M HF (001 SINI)
- Crystal Lacquer<sup>PRO</sup>**
- Crystal Powder Blue HFT (001 L104)
- Crystal Powder Rose HFT (001 L103)

# FLAT BACKS HOTFIX

## PRODUCT DETAILS

Article Size	Packing Unit = Minimum Order Quantity in Pieces	Average Net Weight in Grams per Packing Unit Crystal (001)	Average Gross Weight in Grams per Packing Unit Crystal (001)
<b>2000 A HF</b>			
SS 3	1,440	1.8	12.7
<b>2035 M HF</b>			
6 mm	360	27.1	34.8
10 mm	192	56.2	88.0
14 mm	96	88.4	109.9
<b>2037 M HF</b>			
8 mm	240	14.5	23.6
14 mm	72	12.0	39.9
<b>2038 A HF</b>			
SS 5	1,440	4.2	12.1
SS 6	1,440	5.4	17.7
SS 8	1,440	9.96	18.2
SS 10	1,440	15.54	24.3
<b>2078 A HF</b>			
SS 12	1,440	21.6	30.4
SS 16	1,440	39.1	47.1
SS 20	1,440	72.0	79.6
SS 30	288	34.6	63.0
SS 34	144	26.0	48.6
SS 40	144	43.2	66.9
SS 48	96	61.4	87.4
<b>2078/G A HF</b>			
SS 20	1,440	72.0	79.6
SS 34	144	25.9	48.6
<b>2078/H A HF</b>			
SS 16	1,440	77.6	86.5
SS 20	1,440	130.1	139.0
SS 34	144	38.5	47.4
<b>2078/I A HF</b>			
SS 16	1,440	39.1	47.1
SS 20	1,440	72.0	79.6
SS 34	144	25.9	48.6
<b>2080/4 HF</b>			
SS 10	1,440	17.1	28.3
SS 16	1,440	43.4	54.9
SS 34	144	23.2	34.1
<b>2080/H M HF</b>			
SS 34	144	40.5	49.5
<b>2200 M HF</b>			
8x4 mm	360	24.8	35.8
<b>2204 M HF</b>			
6x4.8 mm	360	27.2	36.4
10x8 mm	144	31.4	53.3
14x11 mm	108	52.6	74.0
<b>2300 M HF</b>			
8x4.8 mm	360	41.9	51.0
<b>2304 M HF</b>			
10x2.8 mm	180	10.2	20.4
14x3.9 mm	96	13.1	36.3

# FLAT BACKS HOTFIX

08 FLAT BACKS HOTFIX

Article Size	Packing Unit = Minimum Order Quantity in Pieces	Average Net Weight in Grams per Packing Unit Crystal (001)	Average Gross Weight in Grams per Packing Unit Crystal (001)
<b>2400 M HF</b>			
3 mm	1,440	25.3	36.8
4 mm	720	30.0	41.0
<b>2483 M HF</b>			
10 mm	144	89.2	119.0
<b>2493 M HF</b>			
8 mm	216	72.3	91.8
10 mm	144	84.4	106.1
12 mm	96	96.4	127.8
<b>2494 M HF</b>			
6 mm	220	22.3	31.4
8 mm	144	29.5	50.2
10.5 mm	96	42.7	63.8
<b>2510 M HF</b>			
5x2.5 mm	720	23.2	32.3
<b>2520 M HF</b>			
8x6 mm	288	50.8	80.2
<b>2540 M HF</b>			
7x5.5 mm	240	39.7	43.6
9x7 mm	144	37.5	59.6
12x9.5 mm	96	66.7	78.2
<b>2555 M HF</b>			
8x2.6 mm	240	18.4	27.5
12x4 mm	144	28.8	33.6
15x5 mm	72	28.9	46.0
<b>2585 M HF</b>			
8 mm	288	48.21	68.08
<b>2610 M HF</b>			
6x4 mm	360	23.5	34.3
<b>2611 M HF</b>			
8 mm	144	29.4	68.1
10 mm	216	93.6	104.3
<b>2708 M HF</b>			
8x8.7 mm	288	28.1	57.3
12.5x13.6 mm	96	49.3	69.3
<b>2709 M HF</b>			
10x6 mm	288	28.9	67.2
<b>2711 M HF</b>			
6 mm	360	29.7	40.7
<b>2714 M HF</b>			
6 mm	360	38.8	49.7
10 mm	144	59.8	84.3
14 mm	108	107.1	132.2
<b>2716 M HF</b>			
5 mm	720	35.8	75.1
<b>2720 M HF</b>			
7.5 mm	240	27.9	37.0

# FLAT BACKS HOTFIX

Article Size	Packing Unit = Minimum Order Quantity in Pieces	Average Net Weight in Grams per Packing Unit Crystal (001)	Average Gross Weight in Grams per Packing Unit Crystal (001)
<b>2728 M HF</b>			
SS 10	1,440	14.1	24.6
SS 16	1,440	38.0	48.8
SS 20	1,440	65.7	76.5
SS 34	144	26.5	37.5
<b>2738 M HF</b>			
10x5 mm	144	16.7	35.1
12x6 mm	96	20.2	38.3
<b>2739 M HF</b>			
5.8x5.3 mm	216	19.2	41.9
7x6.5 mm	144	22.6	39.8
<b>2740 M HF</b>			
8.3x8.3 mm	216	35.1	54.2
10x10 mm	96	25.1	41.1
<b>2753 M HF</b>			
10 mm	72	15.8	39.4
14 mm	36	20.2	40.8
<b>2753/G M HF</b>			
10 mm	72	16.5	35.6
14 mm	36	21.1	41.7
<b>2770 M HF</b>			
6x3.5 mm	1,440	60.3	70.3
12x7 mm	192	49.8	98.4
<b>2788 M HF</b>			
8 mm	288	7.5	18.4
10 mm	216	10.5	37.7
<b>2797 M HF</b>			
8x4 mm	240	14.9	24.0
<b>2798 M HF</b>			
8 mm	360	23.0	33.2
10 mm	144	21.4	44.7
14 mm	108	55.1	83.5
<b>2808 M HF</b>			
6 mm	288	19.8	28.9
10 mm	144	38.8	55.9
14 mm	96	56.4	86.8
<b>2813 M HF</b>			
8x5.5 mm	144	13.1	37.7
10x7 mm	144	23.0	47.6
14x9.5 mm	72	35.3	60.4
<b>2816 M HF</b>			
5 mm	720	23.6	30.7
<b>2817 M HF</b>			
5 mm	720	21.9	31.1
<b>2826 M HF</b>			
5 mm	720	23.06	30.1
<b>2855 M HF</b>			
8 mm	216	46.8	55.9
<b>2858 M HF</b>			
6x4.5 mm	240	12.5	21.7
9x6.5 mm	144	23.4	44.0
12x8.5 mm	96	28.7	49.8

# SWAROVSKI

## CERTIFICATE

H. J. HOFERT, S.L.

meets the high standards set by Swarovski® and has therefore been certified as a

**SWAROVSKI**

AUTHORIZED WHOLESALER

### **This Authorized Wholesaler offers you:**

- An extensive selection of high quality Swarovski crystals
- Good product knowledge on the brand Swarovski
- Flexibility and professionalism in customer service

The staff of this Authorized Wholesaler will be happy to inform you about Swarovski and the latest brand and presentation materials.

The certification is based on a sustainable business relationship with Swarovski and on the agreement of defined standards.

04.10.2016

01.10.2017



DATE AND PLACE OF ISSUE

EXPIRY DATE

SWAROVSKI

Swarovski's suggestions for Authorized Wholesalers are recommendations based on Swarovski's actual experience, current knowledge, and the information provided by the Authorized Wholesaler. Such advice does not prevent you from carrying out your own audits, examination, and selection. The selection of an Authorized Wholesaler is solely the customer's responsibility.