

# 10

## SELF-ADHESIVE ELEMENTS

Self-adhesive Elements such as Crystal-it, Crystal Leatherette-it, Crystal Fabric-it, Crystaltex-it, Crystaltex-it Chaton, Crystal Fine Rocks-it or Crystal Ultrafine Rocks-it are eye-catching and innovative products that come ready-to-apply. When applied on paper and solid surfaces, they can create fantastic designs.

ARTICLE EXPLANATION

Crystal Fabric-it consists of Crystal Fabric with a self-adhesive film.

**57 000**

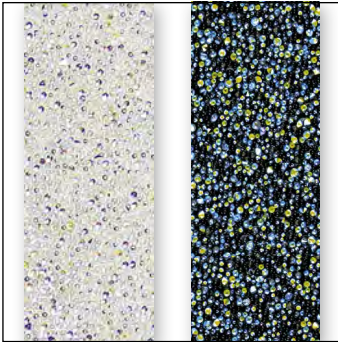

<b>C</b>	001 AB
<b>W</b>	001, 002, 003, 005, 010, 015
<b>M</b>	10 M <sup>1</sup> <b>100%</b>













10 SELF-ADHESIVE ELEMENTS

<b>57 000</b>	<b>C</b>	<b>W</b>	<b>M</b>	<b>100%</b>
Article number	Color of crystals	Width of banding	Minimum order quantity in meters (M)	% of actual size

ORDERING EXAMPLE  
& PRODUCT VARIETY EXPLANATION

<b>57 000</b>	<b>002</b>	<b>010</b>	<b>001 AB</b>
Article number	3-digit code for width	Color of film	Color of crystals
	001 1 cm	I 010 Transparent	Please see the respective product matrix for all available reference codes.
	002 2 cm	I 012 Black	
	003 3 cm		
	005 5 cm		
	010 10 cm		
	015 15 cm		

<sup>1</sup> Please note: the 10-meter packing unit can be delivered in batches (max. three parts with a minimum length of 1.0 meters for each batch).

57 000		Width in cm						Color of Film	
		001	002	003	005	010	015	1010 Transparent	1012 Black
<b>Crystal Effects</b>									
<b>Transparent Effects</b>									
 Crystal Aurore Boreale (001 AB)		■	■	■	■	■	■	■	■
 Crystal Copper (001 COP)		■	■	■	■	■	■	■	■
 Crystal Golden Shadow (001 GSHA)		■	■	■	■	■	■	■	■
 Crystal Heliotrope (001 HEL)		■	■	■	■	■	■	■	■
 Crystal Moonlight (001 MOL)		■	■	■	■	■	■	■	■
 Crystal Paradise Shine (001 PARSH)		■	■	■	■	■	■	■	■
<b>Metallic Effects</b>									
 Crystal Comet Argent Light (001 CAL)		■	■	■	■	■	■	■	■
 Crystal Dorado (001 DOR)		■	■	■	■	■	■	■	■
 Crystal Metallic Light Gold (001 MLGLD)		■	■	■	■	■	■	■	■
<b>Color Effects</b>									
<b>Metallic Effects</b>									
 Jet Hematite (280 HEM)		■	■	■	■	■	■	■	■
 Jet Nut (280 NUT)		■	■	■	■	■	■	■	■
<b>Multicolors</b>									
 Crystal & Crystal Moonlight (001 M500)		■	■	■	■	■	■	■	■

OVERVIEW OF AVAILABLE COLORS & EFFECTS

10 SELF-ADHESIVE ELEMENTS

57 000

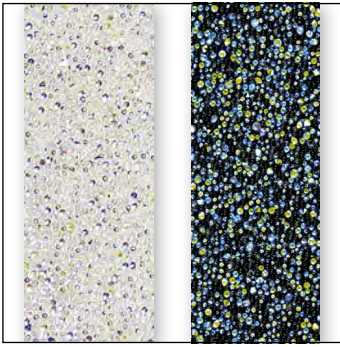

C 001 AB  
W 001,002,003,005,010,015  
M 10 M<sup>1</sup> 100%

57 000



C 001 COP  
W 001,002,003,005,010,015  
M 10 M<sup>1</sup> 100%

57 000



C 001 GSHA  
W 001,002,003,005,010,015  
M 10 M<sup>1</sup> 100%

57 000

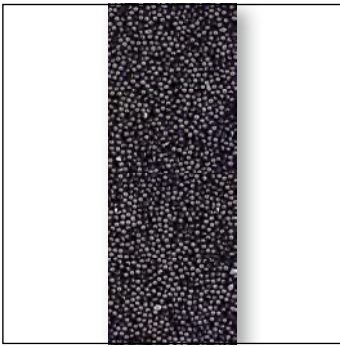

C 001 HEL  
W 001,002,003,005,010,015  
M 10 M<sup>1</sup> 100%

57 000



C 001 MOL  
W 001,002,003,005,010,015  
M 10 M<sup>1</sup> 100%

57 000



C 001 PARSH  
W 001,002,003,005,010,015  
M 10 M<sup>1</sup> 100%

57 000

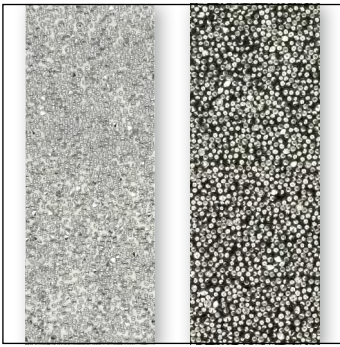

C 001 CAL  
W 001,002,003,005,010,015  
M 10 M<sup>1</sup> 100%

57 000



C 001 DOR  
W 001,002,003,005,010,015  
M 10 M<sup>1</sup> 100%

57 000



C 001 MGLD  
W 001,002,003,005,010,015  
M 10 M<sup>1</sup> 100%

57 000



C 280 HEM  
W 001,002,003,005,010,015  
M 10 M<sup>1</sup> 100%

57 000

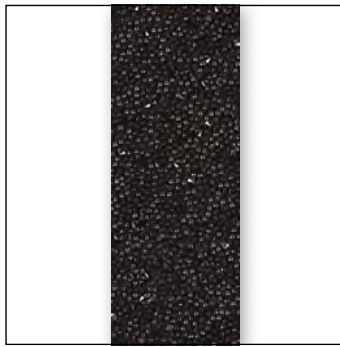

C 280 NUT  
W 001,002,003,005,010,015  
M 10 M<sup>1</sup> 100%

57 000



C 001 M500  
W 001,002,003,005,010,015  
M 10 M<sup>1</sup> 100%

<sup>1</sup> Please note: The packing unit with 10 meter can be delivered divided (max. three parts with a minimum length of 1.0 meter of each part).

ARTICLE EXPLANATION

**57 353**

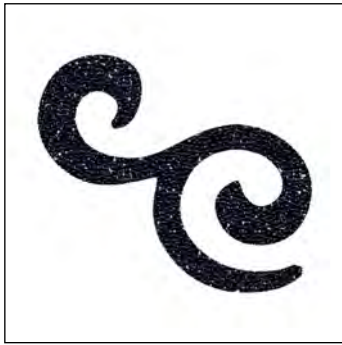

<b>C</b>	012-280HEM
<b>S</b>	~36x31
<b>M</b>	126 PCS   100%

<b>57 353</b>	<b>S</b>	<b>M</b>	<b>100%</b>
Article number	Motif size in mm	Minimum order quantity in pieces (PCS)	% of actual size

ORDERING EXAMPLE  
& PRODUCT VARIETY EXPLANATION

<b>57 353</b>	<b>012</b>	<b>280 HEM</b>
Article number	Type and color of base material	Color of crystals
	I It version  010 Transparent 012 Black	Please see the respective product matrix for all available reference codes.



**57 351**



<b>C</b>	010-001AB
<b>S</b>	~34x30
<b>M</b>	140 PCS <span style="float: right;">100%</span>

**57 352**



<b>C</b>	010-001AB
<b>S</b>	~42x41
<b>M</b>	90 PCS <span style="float: right;">90%</span>

**57 353**



<b>C</b>	012-280HEM
<b>S</b>	~36x31
<b>M</b>	126 PCS <span style="float: right;">100%</span>

ARTICLE EXPLANATION

Crystaltex-it Bandings are available with a transparent and black base material and have a self-adhesive film for application.

**62 000**

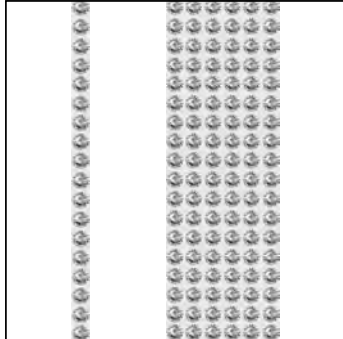

<b>R</b>	001-006
<b>SS</b>	SS 6 (2038)
<b>M</b>	10 M <sup>1</sup> <span style="float: right;"><b>100%</b></span>











<b>62 000</b>	<b>R</b>	<b>SS</b>	<b>M</b>	<b>100%</b>
Article number	This article is available in 1-6 rows.	Stone size	Minimum Order Quantity in meters (M)	% of actual size

ORDERING EXAMPLE & PRODUCT VARIETY EXPLANATION

<b>62 000</b>	<b>006</b>	<b>I010</b>	<b>001</b>
Article number	3-digit code for number of rows	Type and color of base material  I It version  010 Transparent 012 Black	Color of crystals  Please see the respective product matrix for all available reference codes.

<sup>1</sup> Please note: the 10-meter packing unit can be delivered in batches (max. three parts with a minimum length of 1.0 meters for each batch).



62 000 62 010		<b>Stone Size</b>	SS 6	SS 10	<b>Base Material</b>	I010 Transparent	I012 Black
<b>Crystal</b>							
 Crystal (001)		■	■	■	■		
<b>Colors</b>							
<b>Plain Colors</b>							
 Amethyst (204)		■	■	■	■		
 Aquamarine (202)		■	■	■	■		
 Black Diamond (215)		■	■	■	■		
 Jet (280)		■	■	■	■		
 Smoked Topaz (220)		■	■	■	■		
<b>Crystal Effects</b>							
<b>Transparent Effects</b>							
 Crystal AB (001 AB)		■	■	■	■		
 Crystal Golden Shadow (001 GSHA)		■	■	■	■		
 Crystal Silver Shade (001 SSHA)		■	■	■	■		
<b>Metallic Effects</b>							
 Crystal Rose Gold (001 ROGL)		■	■	■	■		
<b>Color Effects</b>							
<b>Metallic Effects</b>							
 Jet Hematite (280 HEM)		■	■	■	■		

10 SELF-ADHESIVE ELEMENTS

ARTICLE EXPLANATION

**62 030**

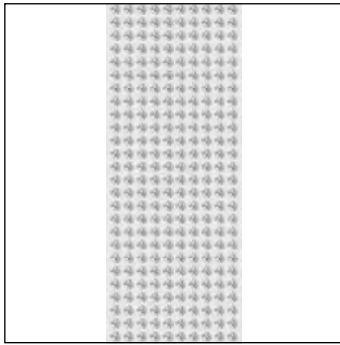

<b>R</b>	002-010, 088
<b>SS</b>	PP 9 (1028)
<b>M</b>	5 M <sup>1</sup>   100%

62 030	R	SS	M	100 %
Article number	This article is available in 2-10 and 88 rows.	Stone size	Minimum order quantity in meters (M)	% of actual size

ORDERING EXAMPLE & PRODUCT VARIETY EXPLANATION

62 030	010	I010	001
Article number	3-digit code for number of rows	Type and color of base material	Color of crystals
		I It Version	Please see the respective product matrix for all available reference codes.
		010Transparent	
		012 Black	

<sup>1</sup> Please note: the 5-meter packing unit can be delivered in batches (max. three parts with a minimum length of 0.5 meters for each batch).

62 030

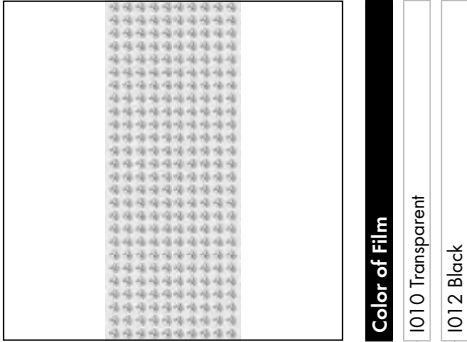

Crystal		Color of Film	
Colors		I010 Transparent	I012 Black
Crystal (001)			
Plain Colors			
Aquamarine (202)			
Black Diamond (215)			
Dark Indigo (288)			
Fuchsia (502)			
Jet (280)			
Light Siam (227)			
Rose (209)			
Smoked Topaz (220)			
Tanzanite (539)			
Crystal Effects			
Transparent Effects			
Crystal Aurore Boreale (001 AB)			
Crystal Golden Shadow (001 GSHA)			
Crystal Silver Shade (001 SSHA)			
Metallic Effects			
Crystal Iridescent Green (001 IRIG)			
Color Effects			
Metallic Effects			
Jet Hematite (280 HEM)			

10 SELF-ADHESIVE ELEMENTS

CRYSTAL FINE ROCKS-IT

Crystal Fine Rocks-it, a highly popular product, is available with the easy-to-use “-it” self-adhesive technique.



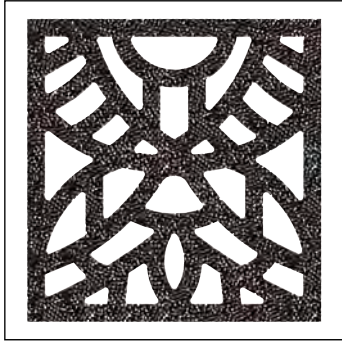























**74 000**



<b>C</b>	I012-280
<b>S</b>	~97x100
<b>M</b>	9 PCS <span style="float: right;">40%</span>

ORDERING EXAMPLE  
& PRODUCT VARIETY EXPLANATION

<b>74 000</b>	<b>I010</b>	<b>001 SSHA</b>
Article number	Color of film	Color of crystals
	I010 Transparent I012 Black	Please see the respective product matrix for all available reference codes.

74 000 – 74 999 (Crystal Fine Rocks-it)		Color of Film	
		I010 Transparent	I012 Black
<b>Crystal</b>			
 Crystal (001)			
<b>Colors</b>			
<b>Plain Colors</b>			
 Erinite (360)			
 Light Siam (227)			
 Jet (280)			
 Sunflower (292)			
 Tangerine (259)			
 Vintage Rose (319)			
<b>Crystal Effects</b>			
<b>Transparent Effects</b>			
 Crystal Aurore Boreale (001 AB)			
 Crystal Bermuda Blue (001 BBL)			
 Crystal Golden Shadow (001 GSHA)			
 Crystal Heliotrope (001 HEL)			
 Crystal			
 Crystal Matt Finish (001 M112)			
 Crystal Matt Finish (001 MAT)			
 Crystal Matt Finish AB (001 MFAB)			
 Crystal Matt Finish Bermuda Blue (001 MFBBL)			
 Crystal Matt Finish Silver Shade (001 MFSSH)			
 Crystal Paradise Shine (001 PARSH)			
 Crystal Red Magma (001 REDM)			
 Crystal Silver Shade (001 SSHA)			
<b>Metallic Effects</b>			
 Crystal Comet Argent Light (001 CAL)			
 Crystal Matt Finish Chrom (001 MFCHR)			
 Crystal Matt Finish Metallic Light Gold (001 MFMLG)			
 Crystal Metallic Light Gold (001 MLGLD)			
 Crystal Metallic Silver (001 METSI)			
<b>Color Effects</b>			
<b>Metallic Effects</b>			
 Jet Nut (280 NUT)			

OVERVIEW OF AVAILABLE COLORS & EFFECTS

Crystal (001)



010 Transparent

Erinite (360)

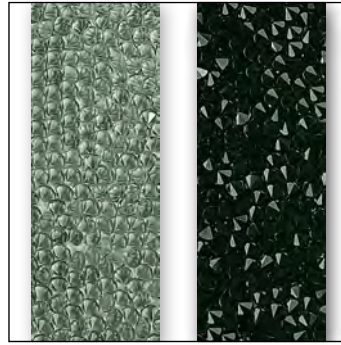

010 Transparent

012 Black

Light Siam (227)

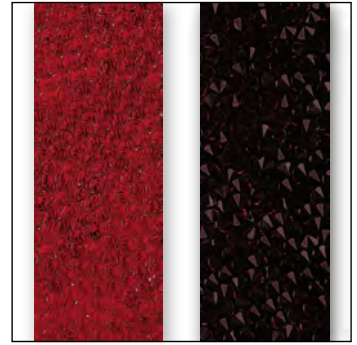

010 Transparent

012 Black

Jet (280)

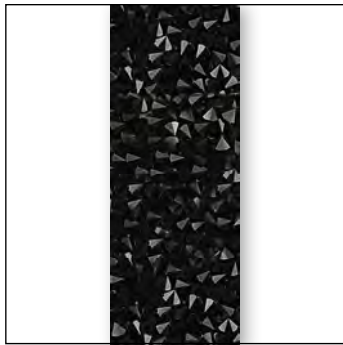

012 Black

Sunflower (292)

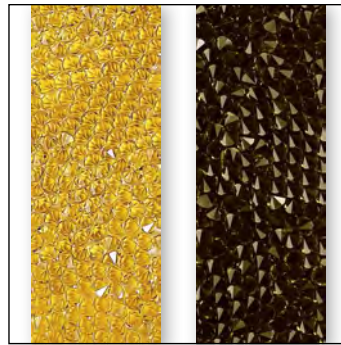

010 Transparent

012 Black

Tangerine (259)

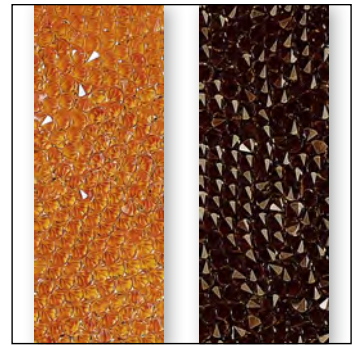

010 Transparent

012 Black

Vintage Rose (319)



010 Transparent

012 Black

Crystal Aurore Boreale (001 AB)

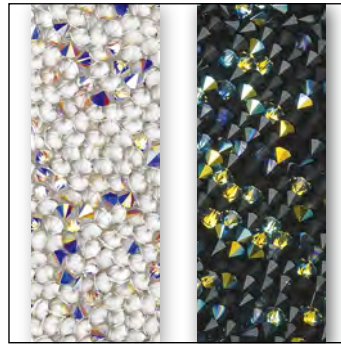

010 Transparent

012 Black

Crystal Bermuda Blue (001 BBL)

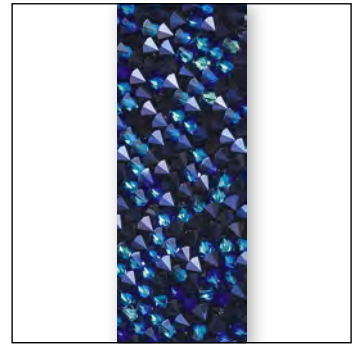

012 Black

Crystal Golden Shadow (001 GSHA)



010 Transparent

Crystal Heliotrope (001 HEL)



012 Black

Crystal & Crystal Matt Finish (001 M112)

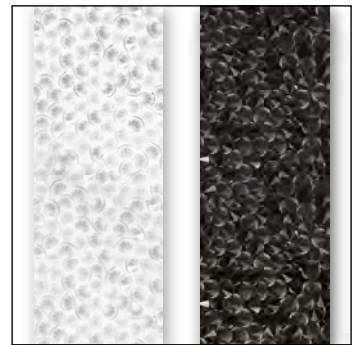

010 Transparent

012 Black

# SELF-ADHESIVE ELEMENTS

# CRYSTAL FINE ROCKS-IT

## OVERVIEW OF AVAILABLE COLORS & EFFECTS

Crystal Matt Finish (001 MAT)

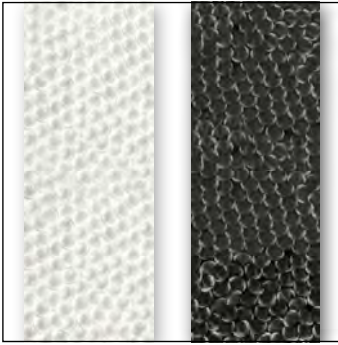

010 Transparent 012 Black

Crystal Matt Finish AB (001 MFAB)

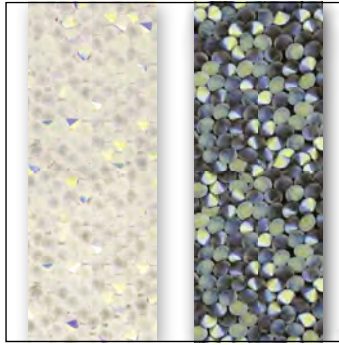

010 Transparent 012 Black

Crystal Matt Finish Bermuda Blue (001 MFBBL)

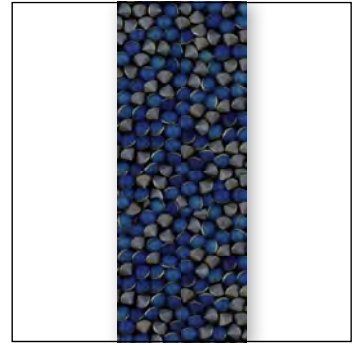

012 Black

Crystal Matt Finish Silver Shade (001 MFSSH)

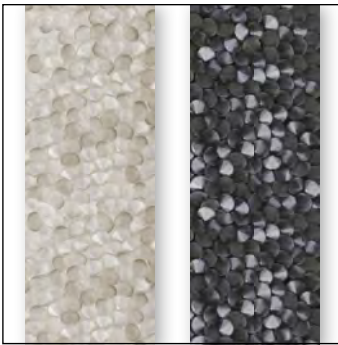

010 Transparent 012 Black

Crystal Paradise Shine (001 PARSH)

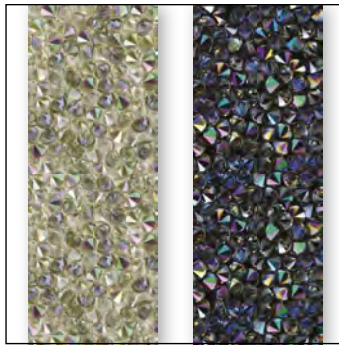

010 Transparent 012 Black

Crystal Red Magma (001 REDM)

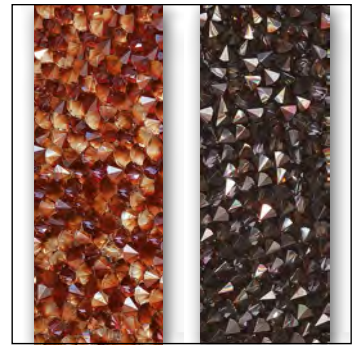

010 Transparent 012 Black

Crystal Silver Shade (001 SSHA)



010 Transparent 012 Black

Crystal Comet Argent Light (001 CAL)



010 Transparent

Crystal Matt Finish Chrom (001 MFCHR)

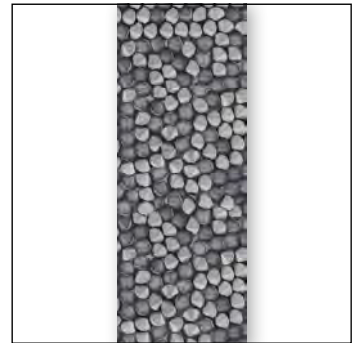

010 Transparent

Crystal Matt Finish Metallic Light Gold (001 MFMLG)



010 Transparent

Crystal Metallic Light Gold (001 MLGLD)



010 Transparent

Crystal Metallic Silver (001 METSI)



010 Transparent 012 Black

OVERVIEW OF AVAILABLE COLORS & EFFECTS

Jet Nut (280 NUT)



012 Black



Crystal-it Infinity is made up of Flat Backs in different shapes, sizes and colors (up to 9 elements per motif possible). An easy-to-apply product due to the specially developed adhesive on the back of the stones. You can create your own individual and exclusive Crystal-it Infinity designs with Swarovski's special motif service.

ARTICLE EXPLANATION

**75 505**

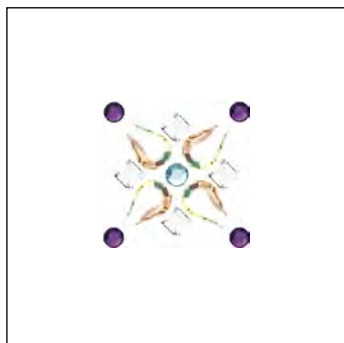

<b>C</b>	204/202/001AB/001
<b>E</b>	S10/S12/CS8x5/CS3x3
<b>S</b>	~19x19 (TAPE : 38x53)
<b>M</b>	32 PCS <span style="float: right;">100%</span>

<b>75 505</b>	<b>C</b>	<b>E</b>	<b>S</b>	<b>M</b>	<b>100%</b>
Article number	Color assortment	Elements	Motif size in mm	Minimum order quantity in pieces (PCS)	% of actual size
	For further details, please refer to the color and product charts at the beginning of this chapter. Color code 1 (204) corresponds to element 1 (S10); color code 2 (202) corresponds to element 2 (S12) etc.	For details of stone sizes and element codes, please refer to the color and product charts at the beginning of this chapter.	and size of the tape the motif is attached to in mm (TAPE)		

ORDERING EXAMPLE & PRODUCT VARIETY EXPLANATION

<b>75 505</b>	<b>022</b>	<b>204</b>	<b>202</b>	<b>001 AB</b>	<b>001</b>
Article number	Carrier film color	Crystal color corresponding to element 1, color of most frequently used element in the motif.	Crystal color corresponding to element 2, color of second most frequently used element in the motif.	Crystal color corresponding to element 3, color of third most frequently used element in the motif.	Crystal color corresponding to element 4, color of fourth most frequently used element in the motif.
	022 White	Please see the respective color chart for all available reference codes.			

2038 XILION Rose

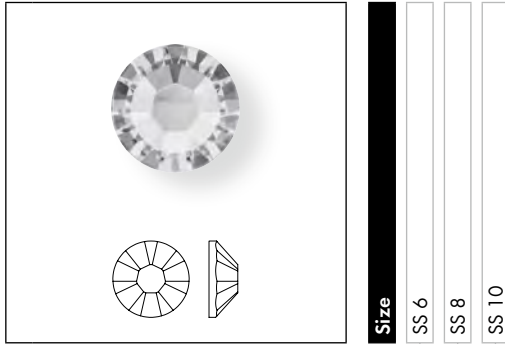

	Size	SS 6	SS 8	SS 10
<b>Crystal</b>				
Crystal (001)		■	■	■
<b>Colors</b>				
<b>Plain Colors</b>				
Amethyst (204)		■	■	■
Aquamarine (202)		■	■	■
Citrine (249)		■	■	■
Fern Green (291)		■	■	■
Fuchsia (502)		■	■	■
Greige (284)		■	■	■
Indian Siam (327)		■	■	■
Jet (280)		■	■	■
Light Peach (362)		■	■	■
Light Rose (223)		■	■	■
Montana (207)		■	■	■
Peridot (214)		■	■	■
Sapphire (206)		■	■	■
Siam (208)		■	■	■
Smoked Topaz (220)		■	■	■
Tanzanite (539)		■	■	■
Topaz (203)		■	■	■
<b>Crystal Effects</b>				
<b>Transparent Effects</b>				
Crystal AB (001 AB)		■	■	■
Crystal Golden Shadow (001 GSHA)		■	■	■
Crystal Silver Night (001 SINI)		■	■	■
Crystal Silver Shade (001 SSHA)		■	■	■
<b>Metallic Effects</b>				
Crystal Dorado (001 DOR)		■	■	■
Crystal Light Chrome (001 LTCH)		■	■	■
Crystal Metallic Light Gold (001 MLGLD)		■	■	■
<b>Color Effects</b>				
<b>Metallic Effects</b>				
Jet Hematite (280 HEM)		■	■	■

2078 XIRIUS Rose

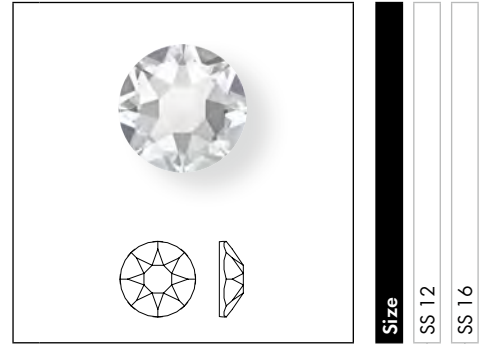

	Size	SS 12	SS 16
<b>Crystal</b>			
Crystal (001)		■	■
<b>Colors</b>			
<b>Plain Colors</b>			
Amethyst (204)		■	■
Aquamarine (202)		■	■
Citrine (249)		■	■
Fern Green (291)		■	■
Fuchsia (502)		■	■
Greige (284)		■	■
Indian Siam (327)		■	■
Jet (280)		■	■
Light Peach (362)		■	■
Light Rose (223)		■	■
Montana (207)		■	■
Peridot (214)		■	■
Sapphire (206)		■	■
Siam (208)		■	■
Smoked Topaz (220)		■	■
Tanzanite (539)		■	■
Topaz (203)		■	■
<b>Crystal Effects</b>			
<b>Transparent Effects</b>			
Crystal AB (001 AB)		■	■
Crystal Golden Shadow (001 GSHA)		■	■
Crystal Silver Night (001 SINI)		■	■
Crystal Silver Shade (001 SSHA)		■	■
<b>Metallic Effects</b>			
Crystal Dorado (001 DOR)		■	■
Crystal Light Chrome (001 LTCH)		■	■
Crystal Metallic Light Gold (001 MLGLD)		■	■
<b>Color Effects</b>			
<b>Metallic Effects</b>			
Jet Hematite (280 HEM)		■	■

SELF-ADHESIVE ELEMENTS

2300 Drop Flat Back



- Crystal**
- Crystal (001)
- Colors**
- Plain Colors**
- Jet (280)
- Crystal Effects**
- Transparent Effects**
- Crystal AB (001 AB)
- Crystal Golden Shadow (001 GSHA)
- Metallic Effects**
- Crystal Light Chrome (001 LTCH)
- Color Effects**
- Metallic Effects**
- Jet Hematite (280 HEM)

FLAT BACKS FOR CRYSTAL-IT INFINITY

2400 Square Flat Back

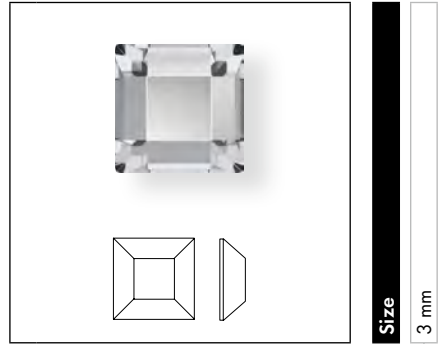

- Crystal**
- Crystal (001)
- Colors**
- Plain Colors**
- Jet (280)
- Crystal Effects**
- Transparent Effects**
- Crystal AB (001 AB)
- Crystal Golden Shadow (001 GSHA)
- Metallic Effects**
- Crystal Light Chrome (001 LTCH)
- Color Effects**
- Metallic Effects**
- Jet Hematite (280 HEM)

2510 Baguette Flat Back

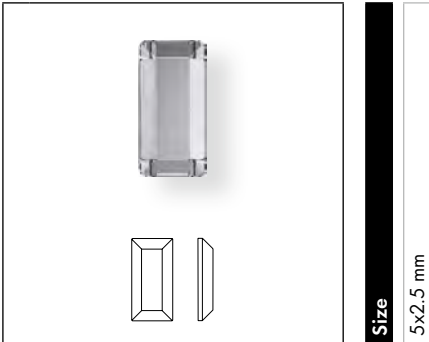

- Crystal**
- Crystal (001)
- Colors**
- Plain Colors**
- Jet (280)
- Crystal Effects**
- Transparent Effects**
- Crystal AB (001 AB)
- Metallic Effects**
- Crystal Light Chrome (001 LTCH)
- Color Effects**
- Metallic Effects**
- Jet Hematite (280 HEM)

2711 Triangle Flat Back

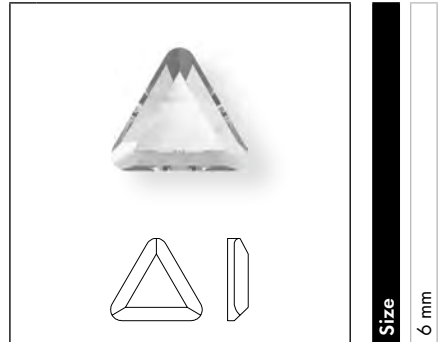

- Crystal**
- Crystal (001)
- Colors**
- Plain Colors**
- Jet (280)
- Crystal Effects**
- Transparent Effects**
- Crystal AB (001 AB)
- Metallic Effects**
- Crystal Light Chrome (001 LTCH)
- Color Effects**
- Metallic Effects**
- Jet Hematite (280 HEM)

SELF-ADHESIVE ELEMENTS

FLAT BACKS FOR CRYSTAL-IT INFINITY

2728 Marguerite Flat Back

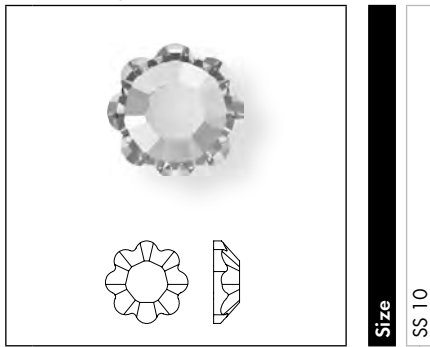

Size  
SS 10

- Crystal**
- Crystal (001)
- Crystal Effects**
- Transparent Effects**
- Crystal AB (001 AB)

2817 Star Flat Back

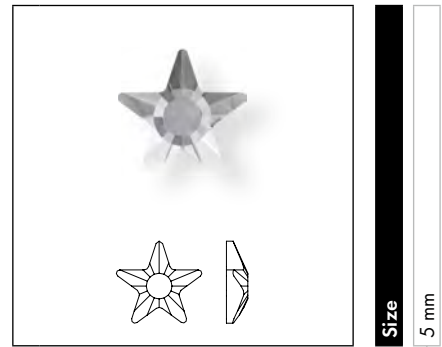

Size  
5 mm

- Crystal**
- Crystal (001)
- Colors**
- Plain Colors**
- Jet (280)
- Crystal Effects**
- Transparent Effects**
- Crystal AB (001 AB)
- Crystal Golden Shadow (001 GSHA)
- Crystal Silver Night (001 SINI)
- Color Effects**
- Metallic Effects**
- Jet Hematite (280 HEM)

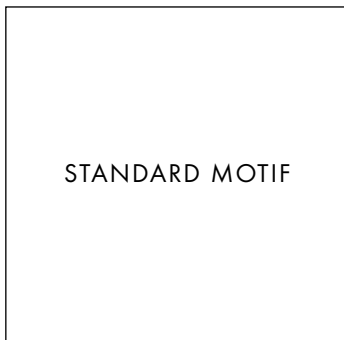

75 500

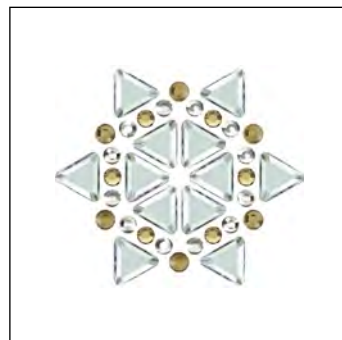

<b>C</b>	001LICH/001GSHA/001MLGLD/001
<b>E</b>	S8/S8/S10/CS6
<b>S</b>	~33x29 (TAPE : 75x53)
<b>M</b>	16 PCS 100%

75 501



<b>C</b>	214/291/001AB/001AB
<b>E</b>	S6/S6/S6/2817MM5
<b>S</b>	~60x37 (TAPE : 75x53)
<b>M</b>	16 PCS 66%

# SELF-ADHESIVE ELEMENTS

# CRYSTAL-IT INFINITY

**75 502**

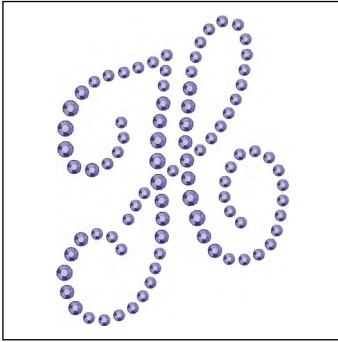

C	539/539/539	
E	S6/S8/S10	
S	~51x38 (TAPE : 75x53)	
M	16 PCS	80%

**75 503**

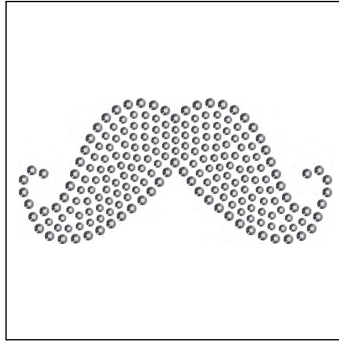

C	280HEM/280HEM	
E	S6/S8	
S	~35x76 (TAPE : 75x105)	
M	8 PCS	55%

**75 504**

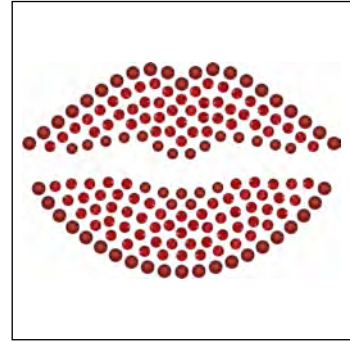

C	327/208/208	
E	S6/S6/S8	
S	~55x38 (TAPE : 75x53)	
M	16 PCS	76%

**75 505**

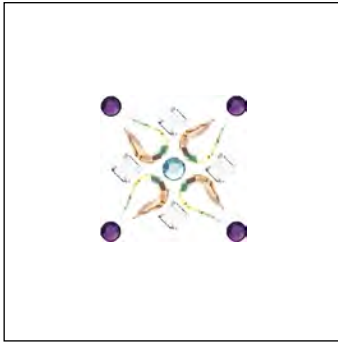

C	204/202/001AB/001	
E	S10/S12/CS8x5/CS3x3	
S	~19x19 (TAPE : 38x53)	
M	32 PCS	100%

**75 506**

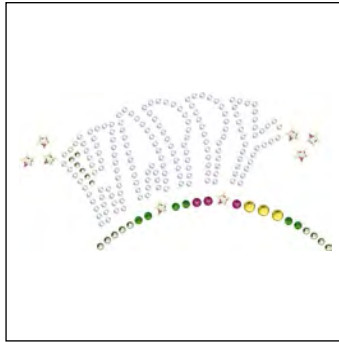

C	001AB/214/214/291/502/249/001AB	
E	S6/S6/S8/S10/S12/S16T/2817MM5	
S	~103x52 (TAPE : 150x105)	
M	4 PCS	40%

**75 507**



C	001GSHA/001/001GSHA/280HEM/001LITCH	
E	S6/S8/CS8x5/CS3x3/CS3x3	
S	~57x34 (TAPE : 75x53)	
M	200 PCS	71%

**75 508**

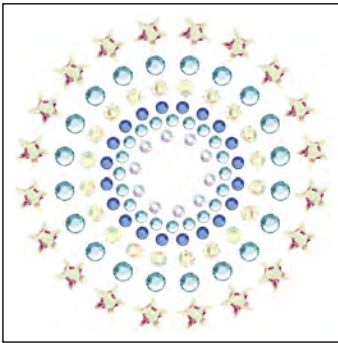

C	202/206/001AB/202/001AB/001AB	
E	S6/S6/S6/S12/CB10/2817MM5	
S	~48x48 (TAPE : 75x105)	
M	8 PCS	86%

**75 509**



C	223/502/223/001/001AB	
E	S6/S6/S8/CB10/2817MM5	
S	~49x36 (TAPE : 75x53)	
M	16 PCS	88%

**75 510**

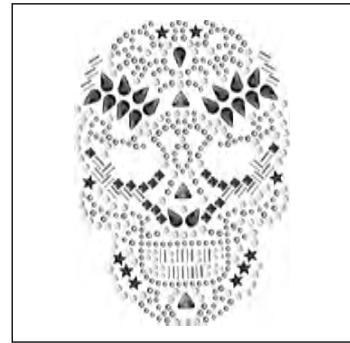

C	280HEM/001/280HEM/001/280HEM/280/280/001LITCH/280	
E	S6/S6/S8/S10/CS6/CS8x5/CS3x3/CS5x2.5/2817MM5	
S	~115x81 (TAPE : 150x105)	
M	4 PCS	35%

**75 511**

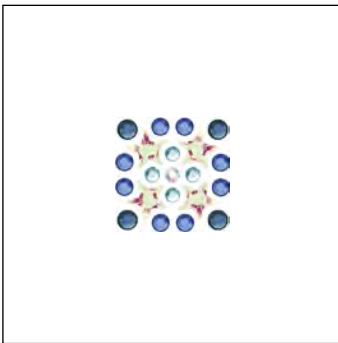

C	202/001AB/206/207/001AB	
E	S6/S6/S8/S10/2817MM5	
S	~15x15 (TAPE : 38x53)	
M	32 PCS	100%

**75 512**

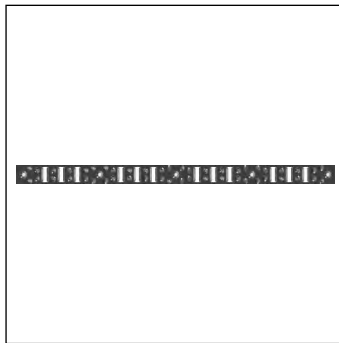

C	001SINI/280HEM/001LITCH	
E	S6/S10/CS5x2.5	
S	~6x110 (TAPE : 43x210)	
M	14 PCS	38%

CRYSTAL ULTRAFINE ROCKS-IT

Small, double-pointed PP9 Chatons create a refined surface structure and flexible texture that is thin and lightweight. Available in a wide selection, Crystal Ultrafine Rocks is set to become the star design element across all segments.

ARTICLE EXPLANATION

**89 905**

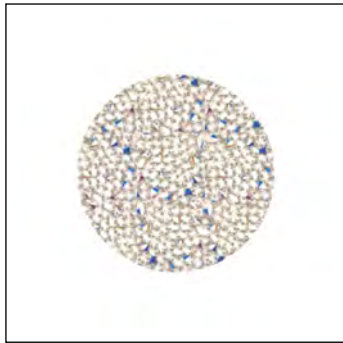

<b>C</b>	I010-001AB
<b>S</b>	~26x26
<b>M</b>	110 PCS
	<b>100%</b>

<b>89 905</b>	<b>C</b>	<b>S</b>	<b>M</b>	<b>100 %</b>
Article number	Color of crystal	Motif size in mm	Minimum order quantity in pieces (PCS)	% of actual size

ORDERING EXAMPLE  
& PRODUCT VARIETY EXPLANATION

<b>89 905</b>	<b>I010</b>	<b>001 AB</b>
Article number	Color of film	Color of crystals
	I010 Transparent I012 Black	Please see the respective product matrix for all available reference codes.

AVAILABLE BASE MATERIALS AND  
CRYSTAL COLORS & EFFECTS

10 SELF-ADHESIVE ELEMENTS

89 900-89 999

Color of Film	I010 Transparent	I012 Black
<b>Crystal</b>		
Crystal (001)	■	
<b>Color</b>		
<b>Plain Color</b>		
Jet (280)	■	
<b>Crystal Effects</b>		
<b>Transparent Effects</b>		
Crystal Aurore Boreale (001 AB)	■	■
Crystal Bermuda Blue (001 BBL)	■	■
Crystal Golden Shadow (001 GSHA)	■	
Crystal Moonlight (001 MOL)	■	■
Crystal Red Magma (001 REDM)	■	■
Crystal Silver Shade (001 SSHA)	■	■
<b>Metallic Effects</b>		
Crystal Comet Argent Light (001 CAL)	■	
Crystal Metallic Light Gold (001 MLGLD)	■	
Crystal Metallic Silver (001 METSI)	■	■

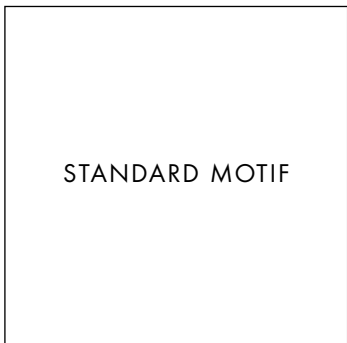

**89 905**

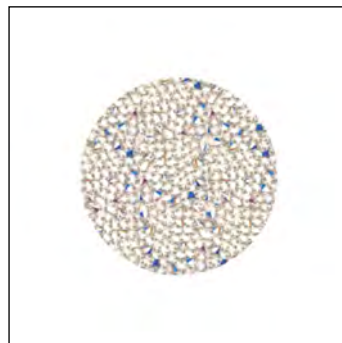

<b>C</b>	I010-001AB	
<b>S</b>	~26x26	
<b>M</b>	110 PCS	<b>100%</b>

OVERVIEW OF AVAILABLE COLORS & EFFECTS

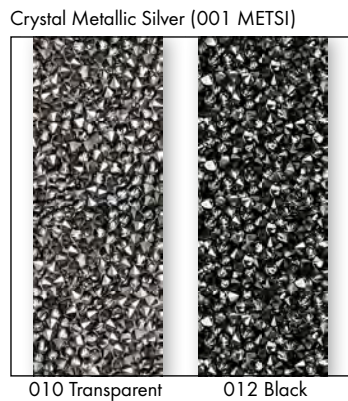
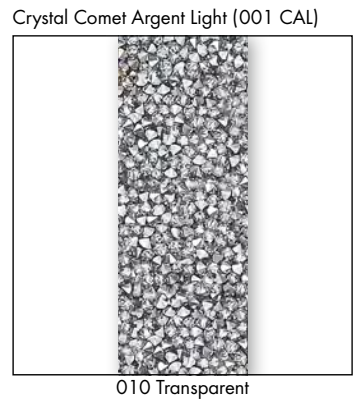
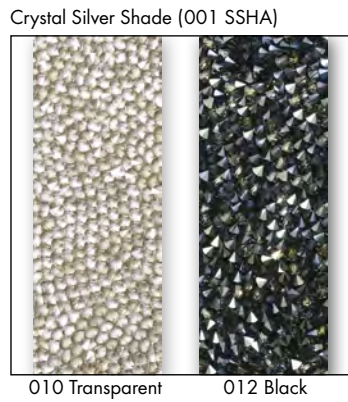
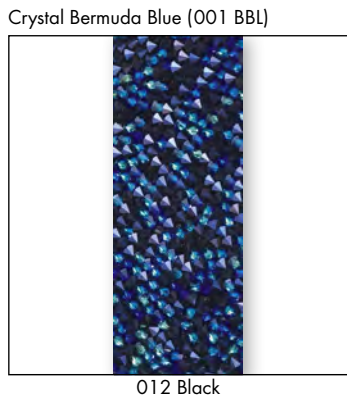
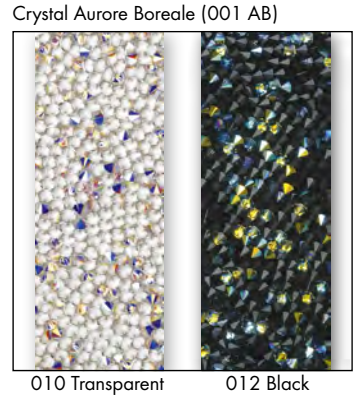
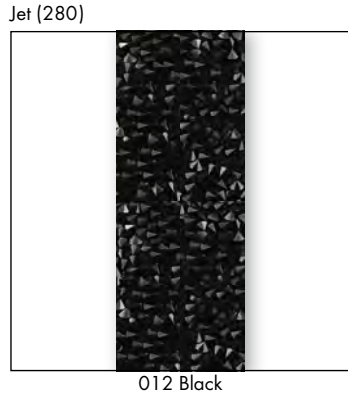
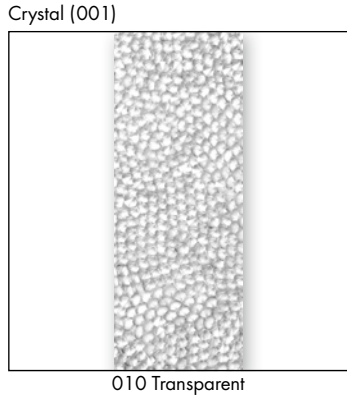



A special motif is any individual design created by the customer that differs to the Self-adhesive Elements Standard or Crystal Inspirations Collections. This service opens up an abundance of customization possibilities and enables you to profit from Swarovski's longstanding experience and design expertise. A range of customization options for existing Motifs is also available (see "Customization Possibilities" below). You can also submit design sketches that meet your specialist requirements – such as a brand image or an image for a particular sales campaign. This will then be made up according to your specifications using Computer Aided Design, which means that adjustments can be made easily according to your needs.

CUSTOMIZATION POSSIBILITIES FOR CRYSTAL-IT INFINITY

- Change of elements and colors of elements of an existing motif
- Change of size of an existing motif
- Logos or brand names
- Up to 9 different elements per motif are possible

CUSTOMIZATION POSSIBILITIES FOR CRYSTAL FABRIC-IT MOTIFS

- Maximum motif size: 600x1800 mm
- Minimum motif size: 10x10 mm or effective surface of 1.00 cm<sup>2</sup>
- Minimum width of holes within motifs: 3 mm
- Minimum Crystal Fabric-it surface: 3 mm
- Minimum size of smallest element within a motif: 10x10 mm or effective surface of 1.00 cm<sup>2</sup>

It is generally possible to draw motifs with a minimum gap of 3 mm between outlines. However, due to the tolerance level of the crystals being applied onto the carrier film, the final Crystal Fabric-it Motifs may differ from the sketches or prints of the motifs' outline, especially with spaces that are smaller than 4 mm. Therefore the motif, and by extension the product itself, may be subject to individual variations with each reproduction. These variations are caused by technical production factors. As these variations are not deemed to be defects, warranty claims will therefore not be considered by Swarovski.

CUSTOMIZATION POSSIBILITIES FOR CRYSTAL FINE ROCKS-IT

- Min. size: 15x15 mm or effective surface of 2.25 cm<sup>2</sup>
- Max. size: 400x330 mm
- Min. Crystal Fine Rocks surface: 4 mm and for Bandings (strips over 10 mm length) 6 mm
- Min. width of holes within motifs: 3 mm
- Min. size of the smallest element within a motif: 15x15 mm or effective surface of 2.25 cm<sup>2</sup>

CUSTOMIZATION POSSIBILITIES FOR CRYSTAL ULTRAFINE ROCKS-IT MOTIFS

- Min. size: 15 x15 mm or effective surface of 2.25cm<sup>2</sup>
- Max. size: 400x330 mm
- Min. Crystal Ultrafine Rocks-it surface: 3.4 mm
- Min. width of holes within motifs: 3 mm
- Min. gap between motif outlines: 9 mm

Due to production issues, motifs with edges and angles of less than 90° need to be rounded off. Tolerance value = 1.0 mm (diameter Ø 2.0mm).

## ORDERING PROCESS

Send your request with the drawing you wish to order to your nearest Swarovski sales office. Make sure you include all measurements for the desired motif. Please also indicate which product group your special motif applies to (Crystal-it, Crystal Fabric-it, Crystaltex-it, Crystaltex-it Chaton, Crystal Fine Rocks-it). You will then receive a quotation including your article number, minimum order quantity, price, and the line drawing of your special motif in PDF format. Please contact your Swarovski sales office again if any changes are required. Your special motif will be produced and delivered following your confirmation.

## PLEASE NOTE

Please always submit the drawing of your desired motif to represent it in the actual size you require. A small sketch, when enlarged to the desired size, will have blurred lines that will make it difficult to correctly reproduce. Pictures or drawings representing 100% size of the design or very good quality scans in JPG, BMP, or DXF format will ensure that we have clear data to work with. These can also be sent via e-mail or on CD-ROM. If you are sending a sewing pattern, please include the whole pattern and not just cut-outs. When the sketch is submitted as a hard copy by fax or e-mail, please include a scale legend (e.g. copy/scan with ruler next to the drawing). This will ensure that the desired size of the motif can be identified.

Special productions are generally offered to all our customers if these are deemed to be feasible and comply with our General Terms and Conditions. Please note that ordering a design does not grant exclusive production of this design to the customer.

If detailed information on potential tolerances is needed (e.g. cavity production for a metal parts), please contact Swarovski who will enter an application request into our application database.

Crystal Leatherette-it is a combination of a chaton transfer motif, artificial leather and an adherent surface, creating a leather sticker solution for all kind of hard surfaces. It comes with or without embossing options in different colors and shapes and a multitude of leather and crystal colors.

ARTICLE EXPLANATION

**88 400**



<b>C</b>	E10224 LB919 001
<b>E</b>	PP17
<b>S</b>	~99x99
<b>M</b>	6PCS <b>40%</b>

10 SELF-ADHESIVE ELEMENTS

<b>88 400</b>	<b>C</b>	<b>E</b>	<b>S</b>	<b>M</b>
Article number	Color assortment	Elements	Motif size in mm	Minimum order quantity in pieces (PCS)

ORDERING EXAMPLE  
& PRODUCT VARIETY EXPLANATION

<b>88 400</b>	<b>E10224</b>	<b>LB919</b>	<b>001</b>
Article number	Embossing	Color of artificial Leather	Color of crystals
	With or without Embossing	Please see respective color matrix	Please see respective color matrix

# SELF-ADHESIVE ELEMENTS

# CRYSTAL LEATHERETTE-IT

OVERVIEW OF ALL AVAILABLE COLORS AND EFFECTS

<p><b>88 400</b> onwards</p>	<b>Sizes</b>	PP 7 (1028)	PP 12 (1028)	PP 17 (1088)
	<b>Crystal</b>	■	■	■
	Crystal (001)	■	■	■
	<b>Colors</b>			
<b>Plain Colors</b>				
Black Diamond (215)	■	■	■	
Jet (280)	■	■	■	
Light Colorado Topaz (246)	■	■	■	
Light Rose (223)	■	■	■	
Light Siam (227)	■	■	■	
Rose (209)	■	■	■	
Sapphire (206)	■	■	■	
<b>Crystal Effects</b>				
<b>Transparent Effects</b>				
Crystal AB (001 AB)	■	■	■	

OVERVIEW OF ALL AVAILABLE LEATHERETTE-IT COLORS (COLORS OF ARTIFICIAL LEATHER)

						
L4920 Violet Blue	LA716 Reed Green	LB598 Rose	LA968 Beige	L4886 Silver Grey	LA720 Blue Grey	L9004 Black
						
L4916 Beige Brown	L4718 Dark Red	L4716 Steel Blue	LB923 Blue Lilac	LB922 Pastel Turquoise	LB919 Grey Beige	

SELF-ADHESIVE ELEMENTS

CRYSTAL LEATHERETTE-IT



STANDARD COLLECTION

88 400



C E10224 LB919 001  
E PP17  
S ~99x99  
M 6PCS 40%

88 401



C E10798 LA968 001AB  
E PP7  
S ~75x27  
M 28 PCS 55%

88 402



C E10234 LA718 246 227  
E PP7  
S ~81x72  
M 12 PCS 50%

88 403

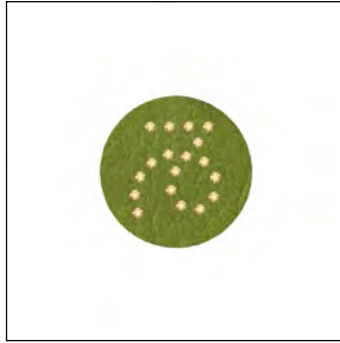

C LA716 246  
E PP7  
S ~20x20  
M 135 PCS 100%

88 404

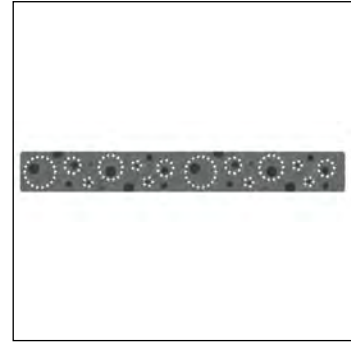

C E10766 LA886 001 001AB  
E PP12  
S ~215x26  
M 12 PCS 20%

88 405



C E10239 LA720 001 223  
E PP7  
S ~51x80  
M 16 PCS 50%

88 406



C E10240 LA920 227  
E PP7  
S ~69x43  
M 21 PCS 60%

88 407



C E10241 LB923 206 001  
E PP7  
S ~120x43  
M 10 PCS 35%

88 408



C E10225 LB922 001 206  
E PP12  
S ~71x50  
M 18 PCS 55%

88 409

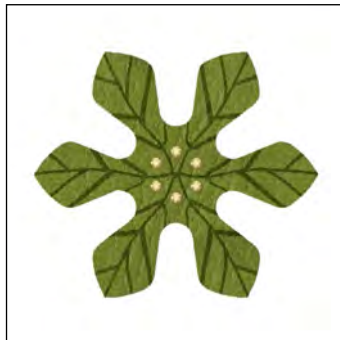

C E10576 LA716 246  
E PP7  
S ~37x32  
M 48 PCS 100%

SPECIAL MOTIF SERVICE

A special motif is a design created by the customer which is different from the Crystal Leatherette-it Collection. This service opens up many customization possibilities and enables you to benefit from Swarovski’s longstanding experience and design expertise. A range of customization options for existing motifs is available (see “Customization Possibilities” below).

You may also submit sketches of a design to suit your personal requirements – such as a brand image or an image that complements a particular sales campaign. This will then be made up according to your specifications using Computer Aided Design, which allows for easy adjustments tailored to your needs.

CUSTOMIZATION POSSIBILITIES

- Change color of an existing crystal stone
- Change color of artificial leather
- Up to three different stone colors per motif are possible
- With or without embossing possible
- Mixing of different stone sizes within one motif is NOT possible

**Required information for Crystal Leatherette-it**

- contour:**
- data format** vector graphics (e.g. .dxf, .ai)
- embossing:**
- data format** raster graphic (png)
- resolution & size** raster graphic should contain size information (300dpi)
- colors** black and white (no greyscale)

DESIGN GUIDELINES

Max. motif size	220x350 mm
Min. motif size	10x10 mm (or effective surface of 1.0 cm <sup>2</sup> )
Min. width of surface within motifs	Part of motif without stone: 3 mm With stone (concentric): PP7: 5.5 mm PP12: 6 mm PP17: 7.5 mm
Offset of embossing	embossed lines that are to meet the outer edge of your design need to be drawn 1 mm over the contour line
Min. line width / dot size of embossed line / dot	0.9 mm / 30 dpi
Min. distance between embossings	0.2 mm / 85 dpi
Min. font size in ref to Arial font	2.5 mm
Distance between stone and embossing	0.8 mm
Distance between stone and contour	2.0 mm
Distance between stones	PP7 1.0 mm, PP12 & PP17 1.5 mm
Tolerance of artificial leather contour	+/- 0.1 mm
Tolerance of stone position used as a dot in a text or placed concentric to an embossed circle	+/- 0.8 mm

ORDERING PROCESS

Send the request with a drawing you wish to order to your nearest Swarovski sales office. Make sure you include all measurements for the desired motif.

You will then receive a quotation including your article number, minimum order quantity, price, and the line drawing of your special motif in PDF format. Please contact your Swarovski sales office again if any changes need to be made.

Your special motif will be produced and delivered following your confirmation.

IMPORTANT INFORMATION

Please always submit your drawing of the desired motif in the actual size you require (dimension of outline and embossing have to be clear). When enlarged to the desired size, a small sketch will have blurred lines that will make it difficult to correctly reinterpret. The information can also be sent via e-mail or on a CD-ROM. If sending a sewing pattern, please include the whole pattern and not just cut outs. If the sketch is submitted as a hard copy by fax or e-mail, please include a scale legend (e.g. copy/scan with ruler next to the drawing). This will ensure that the desired size of the motif can be identified.

If detailed information on possible tolerances is needed (e.g. cavity production for a metal part) please contact Swarovski and an application request will be placed in our application database.

If considered feasible, special productions are generally offered to all our customers. Please note: special productions are subject to acceptance by Swarovski and the order of a design does not automatically grant exclusive production of this design for the customer.

For detailed application information, please refer to the Application Manual and our business website [SWAROVSKI.COM/PROFESSIONAL](http://SWAROVSKI.COM/PROFESSIONAL) or contact your Swarovski sales office.

APPLICATION ADVICE

When gluing Crystal Leatherette-it, the surface has to fulfill all the general requirements for gluing, i.e. it must be clean, dry, and free of oil and grease. Before processing we recommend measuring the tension of the surface with a Test Pen (available from Swarovski, art. 9030/000). A surface tension of at least 38mN/m is recommended for gluing. If the surface tension is below this value, pre-treatment methods have to be executed.

Crystal Leatherette-it can be also applied onto a wide range of solid materials by creating a cavity. The cavity enables the motif to be easily positioned and ensures a higher protection of the motif against mechanical and chemical stress. These cavities can be produced by milling (e.g. CNC machines). For detailed information on tolerances please contact your Swarovski sales office. After the application, it takes around 72 hours until the final adhesive strength is reached. During this time, mechanical stress should be avoided.

Please refer to the Application Manual and our Business Website [SWAROVSKI.COM/PROFESSIONAL](http://SWAROVSKI.COM/PROFESSIONAL).

