





TRANSFERS

Transfers are ideal for Hotfix application on all kinds of textiles. They are available in a large range of motifs and numbers of rows, which are made up of different articles from the Flat Back Hotfix assortment. Featuring designs from our in-house design team, they can include XIRIUS and XILION Roses, or Creation Stones, as well as Metallics and Cabochons.

With Transfers Unlimited, Swarovski presents a spectacular new production technology that makes it possible to combine up to 18 different elements in a single motif, doubling existing design possibilities. The Transfer Motifs offered are divided in two categories: Standard Collection and Crystal Inspiration Collection, meeting all needs in the targeted segments, such as womenswear and sportswear, casualwear, and footwear.

STANDARD COLLECTION
CRYSTAL INSPIRATION COLLECTION

COLORS & EFFECTS

OPEN TO SEE COLORS & EFFECTS

FLAT BACKS FOR TRANSFERS

TRANSFERS

FLAT BACKS HOTFIX

2000 Rose Hotfix

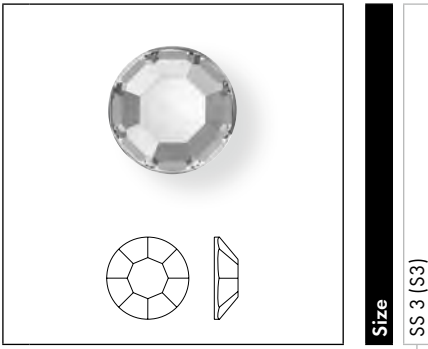

Size
SS 3 (S3)

- Crystal**
- Crystal A HF (001)
- Colors**
- Plain Colors**
- Amethyst A HF (204)
- Aquamarine A HF (202)
- Black Diamond A HF (215)
- Jet A HF (280)
- Light Colorado Topaz A HF (246)
- Light Rose A HF (223)
- Montana A HF (207)
- Peridot A HF (214)
- Smoked Topaz A HF (220)
- Crystal Effects**
- Transparent Effects**
- Crystal AB A HF (001 AB)
- Crystal Golden Shadow A HF (001 GSHA)
- Crystal Silver Shade A HF (001 SSHA)
- Metallic Effects**
- Crystal Metallic Blue A HF (001 METBL)
- Crystal Metallic Light Gold A HF (001 MLGLD)
- Crystal Rose Gold A HF (001 ROGL)
- Color Effects**
- Metallic Effects**
- Jet Hematite A HF (280 HEM)

FLAT BACKS FOR TRANSFERS

2034 Concise Flat Back

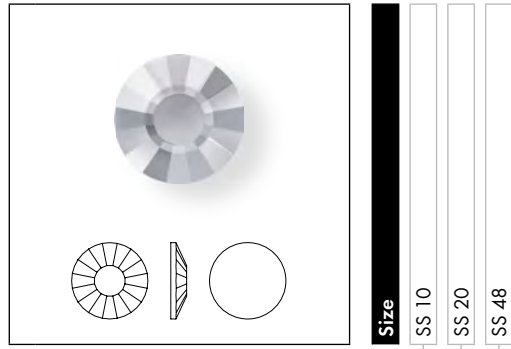

Size
SS 10
SS 20
SS 48

- Crystal**
- Crystal A HF (001)
- Colors**
- Plain Colors**
- Jet A HF (280)
- Light Siam A HF (227)
- Crystal Effects**
- Transparent Effects**
- Crystal AB A HF (001 AB)
- Crystal Golden Shadow A HF (001 GSHA)
- Metallic Effects**
- Crystal Light Chrome A HF (001 LTCH)
- Crystal Patina Effect**
- Crystal Black Patina A HF (001 BLAPA)
- Crystal Rose Patina A HF (001 ROSPA)
- Color Effects**
- Transparent Effects**
- Light Siam AB A HF (227 AB)

TRANSFERS

CREATION STONES

2035 Chessboard Circle

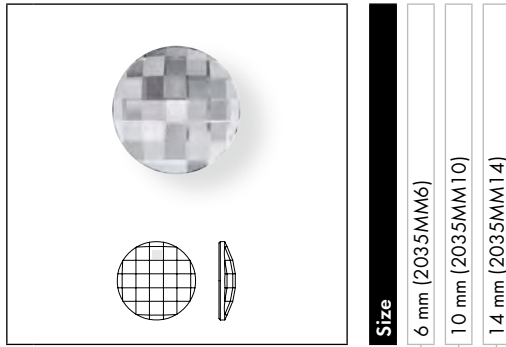

Size

6 mm (2035MM6)

10 mm (2035MM10)

14 mm (2035MM14)

Crystal

Crystal M HF (001)

Colors

Plain Colors

Jet M HF (280)

Crystal Effects

Transparent Effects

Crystal AB M HF (001 AB)

2037 Eclipse Flat Back

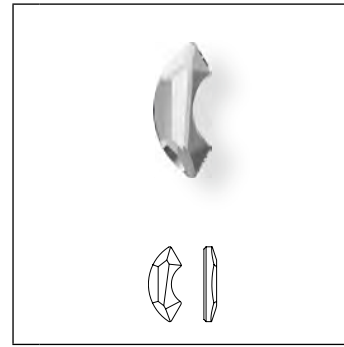

Size

8 mm

14 mm

Crystal

Crystal M HF (001)

TRANSFERS

2038 XILION Rose Hotfix

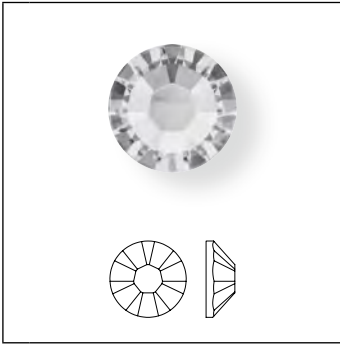

Size	SS 5	SS 6	SS 8	SS 10
------	------	------	------	-------

Crystal

- Crystal A HF (001)
- Crystal Hotfix Transparent (001 HFT)

Colors

Plain Colors

- Amethyst A HF (204)
- Aquamarine A HF (202)
- Black Diamond A HF (215)
- Blue Zircon A HF (229)
- Blush Rose A HF (257)
- Burgundy A HF (515)
- Capri Blue A HF (243)
- Chalkwhite A HF (279)
- Chrysolite A HF (238)
- Citrine A HF (249)
- Cobalt A HF (369)
- Dark Indigo A HF (288)
- Denim Blue A HF (266)
- Emerald A HF (205)
- Erinite A HF (360)
- Fern Green A HF (291)
- Fireopal A HF (237)
- Fuchsia A HF (502)
- Graphite A HF (253)
- Greige A HF (284)
- Hyacinth A HF (236)
- Indian Pink A HF (289)
- Indian Siam A HF (327)
- Jet A HF (280)
- Jonquil A HF (213)
- Khaki A HF (550)
- Light Amethyst A HF (212)
- Light Colorado Topaz A HF (246)
- Light Peach A HF (362)
- Light Rose A HF (223)
- Light Sapphire A HF (211)
- Light Siam A HF (227)
- Light Silk A HF (261)
- Light Topaz A HF (226)
- Light Turquoise A HF (263)
- Mocca A HF (286)
- Montana A HF (207)

FLAT BACKS FOR TRANSFERS

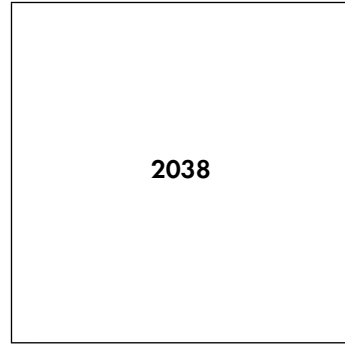

Size	SS 5	SS 6	SS 8	SS 10
------	------	------	------	-------

- Olivine A HF (228)
 - Padparadscha A HF (542)
 - Peridot A HF (214)
 - Provence Lavender A HF (283)
 - Purple Velvet A HF (277)
 - Rose A HF (209)
 - Rose Peach A HF (262)
 - Ruby A HF (501)
 - Sapphire A HF (206)
 - Siam A HF (208)
 - Silk A HF (391)
 - Smoked Topaz A HF (220)
 - Smoky Mauve A HF (265)
 - Sunflower A HF (292)
 - Tangerine A HF (259)
 - Tanzanite A HF (539)
 - Topaz A HF (203)
 - Vintage Rose A HF (319)
- ### Opal Colors
- Light Grey Opal A HF (383)
 - Pacific Opal A HF (390)
 - White Opal A HF (234)
 - Yellow Opal A HF (231)
- ### Crystal Effects
- #### Transparent Effects
- Crystal AB A HF (001 AB)
 - Crystal Antique Pink A HF (001 ANTP)
 - Crystal Blue Shade A HF (001 BLSH)
 - Crystal Bronze Shade A HF (001 BRSH)
 - Crystal Copper A HF (001 COP)
 - Crystal Cosmojet A HF (001 COS)
 - Crystal Golden Shadow A HF (001 GSHA)
 - Crystal Lilac Shadow A HF (001 LISH)
 - Crystal Luminous Green A HF (001 LUMG)
 - Crystal Meridian Blue A HF (001 MBL)
 - Crystal Moonlight A HF (001 MOL)
 - Crystal Paradise Shine A HF (001 PARSH)
 - Crystal Silver Night A HF (001 SINI)
 - Crystal Silver Shade A HF (001 SSHA)
 - Crystal Transmission HFT (001 TRA HFT)
 - Crystal Volcano A HF (001 VOL)

	Size	SS 5	SS 6	SS 8	SS 10
2038					
Metallic Effects					
Crystal Dorado A HF (001 DOR)		■	■	■	
Crystal Iridescent Green A HF (001 IRIG)		■	■	■	
Crystal Light Chrome A HF (001 LTCH)		■	■	■	
Crystal Metallic Blue A HF (001 METBL)		■	■	■	
Crystal Metallic Light Gold A HF (001 MLGLD)		■	■	■	
Crystal Metallic Sunshine A HF (001 METSH)		■	■	■	
Crystal Rainbow Dark A HF (001 RABDK)		■	■	■	
Crystal Rose Gold A HF (001 ROGL)		■	■	■	
Crystal Scarabaeus Green*** A HF (001 SCGR)		■	■	■	
Crystal Lacquer^{PRO}					
Crystal Powder Blue HFT (001 L104)					■
Crystal Powder Green HFT (001 L102)					■
Crystal Powder Rose HFT (001 L103)					■
Crystal Powder Yellow HFT (001 L101)					■
Crystal Dark Grey HFT (001 L111S)					■
Crystal Dark Red HFT (001 L108S)					■
Crystal Ivory Cream HFT (001 L106S)					■
Crystal Royal Blue HFT (001 L110S)					■
Crystal Royal Green HFT (001 L109S)					■
Crystal Royal Red HFT (001 L107S)					■
Color Effects					
Transparent Effects					
Blue Zircon Satin A HF (229 SAT)		■	■	■	
Jet AB A HF (280 AB)		■	■	■	
Jonquil AB A HF (213 AB)		■	■	■	
Jonquil Satin A HF (213 SAT)		■	■	■	
Light Rose AB A HF (223 AB)		■	■	■	
Light Siam AB A HF (227 AB)		■	■	■	
Light Siam Satin A HF (227 SAT)		■	■	■	
Sapphire Satin A HF (206 SAT)		■	■	■	
Metallic Effects					
Jet Hematite A HF (280 HEM)		■	■	■	■
Jet Nut A HF (280 NUT)		■	■	■	■

*** designed by Jean Paul Gaultier

TRANSFERS

FLAT BACKS FOR TRANSFERS

2078 XIRIUS Rose Hotfix

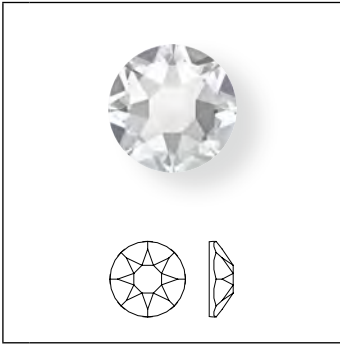

Size	SS 12	SS 16	SS 20	SS 30	SS 34	SS 40	SS 48
------	-------	-------	-------	-------	-------	-------	-------

Crystal

Crystal A HF (001)	■	■	■	■	■	■	■
Crystal Hotfix Transparent (001 HFT)		■					

Colors

Plain Colors

Amethyst A HF (204)	■	■	■		■		
Aquamarine A HF (202)	■	■	■		■		
Black Diamond A HF (215)	■	■	■		■		
Blue Zircon A HF (229)	■	■	■		■		
Blush Rose A HF (257)	■	■	■		■		
Burgundy A HF (515)	■	■	■		■		
Capri Blue A HF (243)	■	■	■		■		
Chalkwhite A HF (279)	■	■	■		■		
Chrysolite A HF (238)	■	■	■		■		
Citrine A HF (249)	■	■	■		■		
Cobalt A HF (369)	■	■	■		■		
Dark Indigo A HF (288)	■	■	■		■		
Denim Blue A HF (266)	■	■	■		■		
Emerald A HF (205)	■	■	■		■		
Erinite A HF (360)	■	■	■		■		
Fern Green A HF (291)	■	■	■		■		
Fireopal A HF (237)	■	■	■		■		
Fuchsia A HF (502)	■	■	■		■		
Graphite A HF (253)	■	■	■		■		
Greige A HF (284)	■	■	■		■		
Hyacinth A HF (236)	■	■	■		■		
Indian Pink A HF (289)	■	■	■		■		
Indian Siam A HF (327)	■	■	■		■		
Jet A HF (280)	■	■	■	■	■		
Jonquil A HF (213)	■	■	■		■		
Khaki A HF (550)	■	■	■		■		
Light Amethyst A HF (212)	■	■	■		■		
Light Colorado Topaz A HF (246)	■	■	■		■		
Light Peach A HF (362)	■	■	■		■		
Light Rose A HF (223)	■	■	■		■		
Light Sapphire A HF (211)	■	■	■		■		
Light Siam A HF (227)	■	■	■	■	■		
Light Silk A HF (261)	■	■	■		■		
Light Topaz A HF (226)	■	■	■		■		
Light Turquoise A HF (263)	■	■	■		■		
Mocca A HF (286)	■	■	■		■		
Montana A HF (207)	■	■	■	■	■		

2078		Size	SS 12	SS 16	SS 20	SS 30	SS 34	SS 40	SS 48
	Olivine A HF (228)		■	■	■		■		
	Padparadscha A HF (542)		■	■	■		■		
	Peridot A HF (214)		■	■	■		■		
	Provence Lavender A HF (283)		■	■	■		■		
	Purple Velvet A HF (277)		■	■	■		■		
	Rose A HF (209)		■	■	■		■		
	Rose Peach A HF (262)		■	■	■		■		
	Ruby A HF (501)		■	■	■		■		
	Sapphire A HF (206)		■	■	■		■		
	Siam A HF (208)		■	■	■		■		
	Silk A HF (391)		■	■	■		■		
	Smoked Topaz A HF (220)		■	■	■		■		
	Smoky Mauve A HF (265)		■	■	■		■		
	Sunflower A HF (292)		■	■	■		■		
	Tangerine A HF (259)		■	■	■		■		
	Tanzanite A HF (539)		■	■	■		■		
	Topaz A HF (203)		■	■	■		■		
	Vintage Rose A HF (319)		■	■	■		■		
Opal Colors									
	Light Grey Opal A HF (383)		■	■	■		■		
	Pacific Opal A HF (390)		■	■	■		■		
	White Opal A HF (234)		■	■	■		■		
	Yellow Opal A HF (231)		■	■	■		■		
Crystal Effects									
Transparent Effects									
	Crystal AB A HF (001 AB)		■	■	■	■	■	■	■
	Crystal Antique Pink A HF (001 ANTP)		■	■	■		■		
	Crystal Blue Shade A HF (001 BLSH)		■	■	■		■		
	Crystal Bronze Shade A HF (001 BRSH)		■	■	■		■		
	Crystal Copper A HF (001 COP)		■	■	■		■		
	Crystal Cosmojet A HF (001 COS)		■	■					
	Crystal Golden Shadow A HF (001 GSHA)		■	■	■	■	■		
	Crystal Lilac Shadow A HF (001 LISH)		■	■	■		■		
	Crystal Luminous Green A HF (001 LUMG)		■	■	■		■		
	Crystal Meridian Blue A HF (001 MBL)		■	■	■		■		
	Crystal Moonlight A HF (001 MOL)		■	■	■		■		
	Crystal Paradise Shine A HF (001 PARSH)		■	■	■		■		
	Crystal Silver Night A HF (001 SINI)		■	■	■		■		
	Crystal Silver Shade A HF (001 SSHA)		■	■	■		■		
	Crystal Transmission HFT (001 TRA HFT)		■	■	■		■		
	Crystal Volcano A HF (001 VOL)		■	■	■				

TRANSFERS

FLAT BACKS FOR TRANSFERS

	Size	SS 12	SS 16	SS 20	SS 30	SS 34	SS 40	SS 48
2078								
Metallic Effects								
Crystal Dorado A HF (001 DOR)		■	■	■		■		
Crystal Iridescent Green A HF (001 IRIG)		■	■	■		■		
Crystal Light Chrome A HF (001 LTCH)		■	■	■		■		
Crystal Metallic Blue A HF (001 METBL)		■	■	■		■		
Crystal Metallic Light Gold A HF (001 MLGLD)		■	■	■		■		
Crystal Metallic Sunshine A HF (001 METSH)		■	■	■		■		
Crystal Rainbow Dark A HF (001 RABDK)		■	■	■		■		
Crystal Rose Gold A HF (001 ROGL)		■	■	■		■		
Crystal Scarabaeus Green***A HF (001 SCGR)		■	■	■		■		
Crystal Lacquer^{PRO}								
Crystal Powder Blue HFT (001 L104)			■			■		
Crystal Powder Green HFT (001 L102)			■			■		
Crystal Powder Rose HFT (001 L103)			■			■		
Crystal Powder Yellow HFT (001 L101)			■			■		
Crystal Dark Grey HFT (001 L111S)			■			■		
Crystal Dark Red HFT (001 L108S)			■			■		
Crystal Ivory Cream HFT (001 L106S)			■			■		
Crystal Royal Blue HFT (001 L110S)			■			■		
Crystal Royal Green HFT (001 L109S)			■			■		
Crystal Royal Red HFT (001 L107S)			■			■		
Color Effects								
Transparent Effects								
Blue Zircon Satin A HF (229 SAT)		■	■	■		■		
Jet AB A HF (280 AB)		■	■	■		■		
Jonquil AB A HF (213 AB)		■	■	■		■		
Jonquil Satin A HF (213 SAT)		■	■	■		■		
Light Rose AB A HF (223 AB)		■	■	■		■		
Light Siam AB A HF (227 AB)		■	■	■		■		
Light Siam Satin A HF (227 SAT)		■	■	■		■		
Sapphire Satin A HF (206 SAT)		■	■	■		■		
Metallic Effects								
Jet Hematite A HF (280 HEM)		■	■	■	■	■		
Jet Nut A HF (280 NUT)		■	■	■		■		

2078/G XIRIUS Rose partly frosted

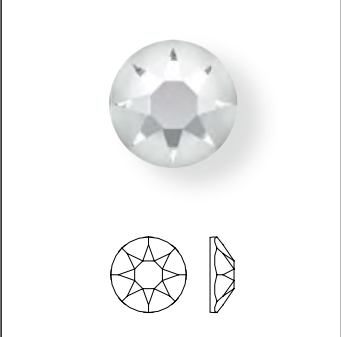
	Size	SS 20	SS 34
		■	■
Crystal			
Crystal A HF (001)		■	■
Colors			
Plain Colors			
Jet A HF (280)		■	■

*** designed by Jean Paul Gaultier

TRANSFERS

FLAT BACKS FOR TRANSFERS

2078/H Framed Flat Back

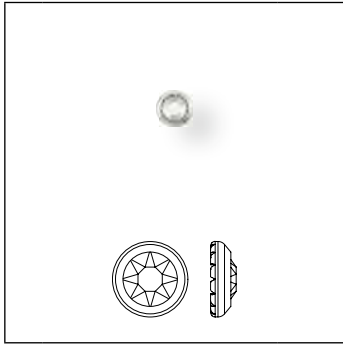

SS SS 16
M 1,440 PCS 100%

2078/H Framed Flat Back

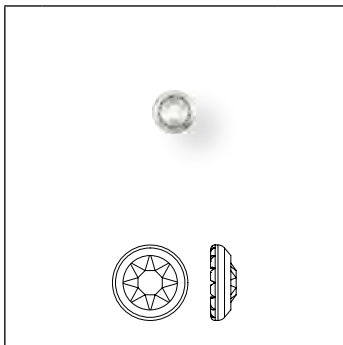

SS SS 20
M 1,440 PCS 100%

2078/H Framed Flat Back

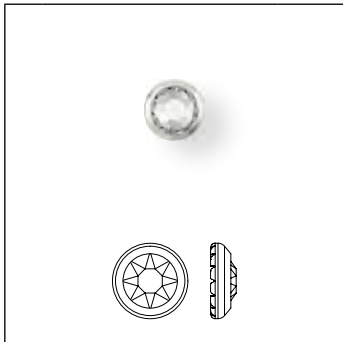

SS SS 34
M 144 PCS 100%

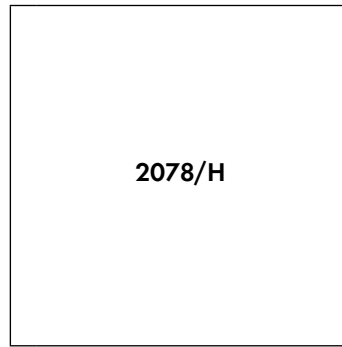

- Crystal**
- Crystal A HF (001)
- Colors**
- Plain Colors**
- Denim Blue A HF (266)
- Jet A HF (280)
- Crystal Effects**
- Transparent Effects**
- Crystal Golden Shadow A HF (001 GSHA)
- Color Effects**
- Transparent Effects**
- Jet Hematite A HF (280 HEM)

Size & color of ring	SS 16 Gold (GR)	SS 16 Silver (SR)	SS 16 Gun Metal (GM)	SS 20 Gold (GR)	SS 20 Silver (SR)	SS 20 Gun Metal (GM)	SS 34 Gold (GR)	SS 34 Silver (SR)	SS 34 Gun Metal (GM)
Crystal A HF (001)	■	■	■	■	■	■	■	■	■
Denim Blue A HF (266)	■	■	■	■	■	■	■	■	■
Jet A HF (280)	■	■	■	■	■	■	■	■	■
Crystal Golden Shadow A HF (001 GSHA)	■	■	■	■	■	■	■	■	■
Jet Hematite A HF (280 HEM)	■	■	■	■	■	■	■	■	■

TRANSFERS

2078/I Rimmed Flat Back

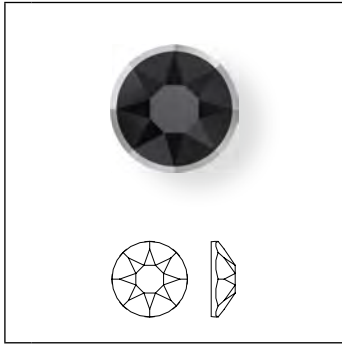

Size	SS 16	SS 20	SS 34
------	-------	-------	-------

Crystal Effects

Metallic Effects

- Crystal & Dorado Z AHF (001 DORZ)
- Crystal & Lt. Chrome Z A HF (001 LTCHZ)

Color Effects

Metallic Effects

- Black Diamond & Dorado Z A HF (215 DORZ)
- Black Diamond & Lt. Chrome Z A HF (215 LTCHZ)
- Burgundy & Dorado Z A HF (515 DORZ)
- Burgundy & Lt. Chrome Z A HF (515 LTCHZ)
- Denim Blue & Dorado Z A HF (266 DORZ)
- Denim Blue & Lt. Chrome Z A HF (266 LTCHZ)
- Greige & Dorado Z A HF (284 DORZ)
- Greige & Lt. Chrome Z A HF (284 LTCHZ)
- Jet & Dorado Z A HF (280 DORZ)
- Jet & Lt. Chrome Z A HF (280 LTCHZ)
- Khaki & Dorado Z A HF (550 DORZ)
- Khaki & Lt. Chrome Z A HF (550 LTCHZ)
- Light Siam & Dorado Z A HF (227 DORZ)
- Light Siam & Lt. Chrome Z A HF (227 LTCHZ)
- White Opal & Dorado Z A HF (234 DORZ)
- White Opal & Lt. Chrome Z A HF (234 LTCHZ)

FLAT BACKS FOR TRANSFERS

2080/H Framed Cabochon

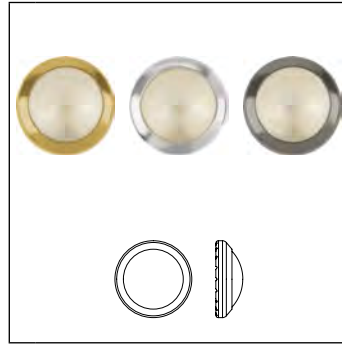

Size & color of ring	SS 34 Gold (GR)	SS 34 Silver (SR)	SS 34 Gun Metal (GM)
----------------------	-----------------	-------------------	----------------------

Colors

Plain Colors

- Jet M HF (280)

Crystal Pearl Colors

- Crystal Cream Pearl HF (001 291)
- Crystal White Pearl HF (001 650)

Crystal Effects

Transparent Effects

- Crystal Golden Shadow HF (001 GSHA)
- Crystal Nacre HF (001 191)

Crystal Color Effects

Metallic Effects

- Jet Hematite M HF (280 HEM)

TRANSFERS

2180/4

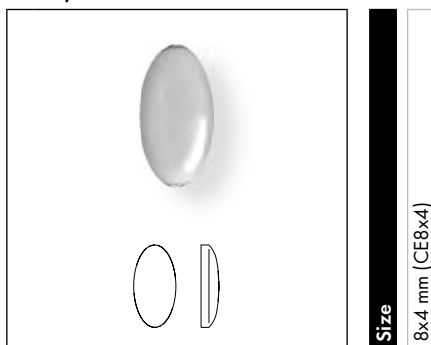

Size
8x4 mm (CE8x4)

- Crystal**
- Crystal M HF (001)
- Colors**
- Plain Colors
- Jet M HF (280)
- Crystal Effects**
- Transparent Effects
- Crystal AB M HF (001 AB)
- Color Effects**
- Metallic Effects
- Jet Hematite M HF (280 HEM)

FLAT BACKS FOR TRANSFERS

2200 Navette Flat Back

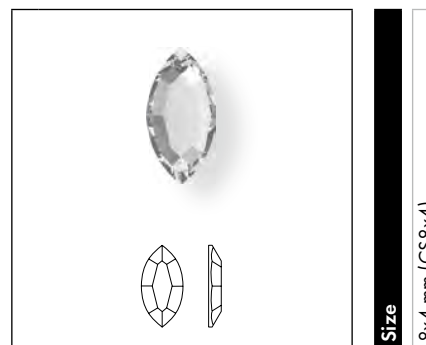

Size
8x4 mm (CS8x4)

- Crystal**
- Crystal M HF (001)
- Colors**
- Plain Colors
- Jet M HF (280)
- Crystal Effects**
- Transparent Effects
- Crystal AB M HF (001 AB)
- Crystal Golden Shadow M HF (001 GSHA)
- Crystal Silver Shade M HF (001 SSHA)
- Color Effects**
- Metallic Effects
- Jet Hematite M HF (280 HEM)

TRANSFERS

2205 Flame Flat Back

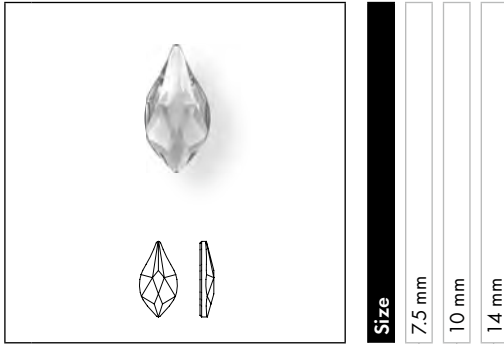

Size
7.5 mm
10 mm
14 mm

Crystal			
Crystal M HF (001)	■	■	■
Colors			
Plain Colors			
Fireopal M HF (237)	■	■	■
Jet M HF (280)	■	■	■
Light Colorado Topaz M HF (246)	■	■	■
Light Siam M HF (227)	■	■	■
Opal Colors			
White Opal M HF (234)	■	■	■
Crystal Effects			
Transparent Effects			
Crystal AB M HF (001 AB)	■	■	■
Crystal Golden Shadow M HF (001 GSHA)	■	■	■
Crystal Silver Night M HF (001 SINI)	■	■	■
Metallic Effects			
Crystal Iridescent Green M HF (001 IRIG)	■	■	■

FLAT BACKS FOR TRANSFERS

2300 Drop Flat Back



Size
8x4.8 mm (CS8x5)

Crystal	
Crystal M HF (001)	■
Colors	
Plain Colors	
Jet M HF (280)	■
Crystal Effects	
Transparent Effects	
Crystal AB M HF (001 AB)	■
Crystal Golden Shadow M HF (001 GSHA)	■
Metallic Effects	
Crystal Light Chrome M HF (001 LTCH)	■
Color Effects	
Metallic Effects	
Jet Hematite M HF (280 HEM)	■

TRANSFERS

2304 Raindrop Flat Back

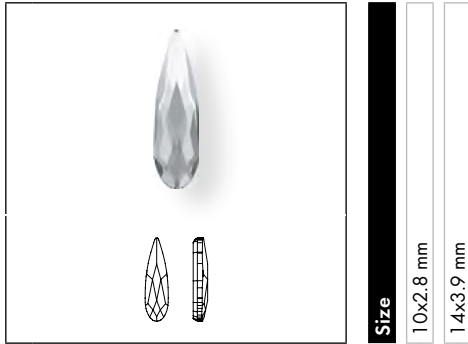

Size
10x2.8 mm
14x3.9 mm

Crystal

Crystal M HF (001)

Colors

Plain Colors

Blush Rose M HF (257)

Jet M HF (280)

Light Siam M HF (227)

Crystal Effects

Transparent Effects

Crystal AB M HF (001 AB)

Crystal Blue Shade M HF (001 BLSH)

Crystal Golden Shadow M HF (001 GSHA)

Crystal Luminous Green M HF (001 LUMG)

Crystal Silver Night M HF (001 SINI)

FLAT BACKS FOR TRANSFERS

2400 Square Flat Back

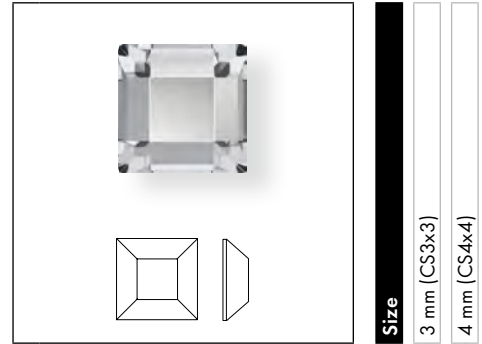

Size
3 mm (CS3x3)
4 mm (CS4x4)

Crystal

Crystal M HF (001)

Colors

Plain Colors

Graphite M HF (253)

Jet M HF (280)

Crystal Effects

Transparent Effects

Crystal AB M HF (001 AB)

Crystal Golden Shadow M HF (001 GSHA)

Metallic Effects

Crystal Light Chrome M HF (001 LTCH)

Color Effects

Metallic Effects

Jet Hematite M HF (280 HEM)

2483 Classic Square Flat Back

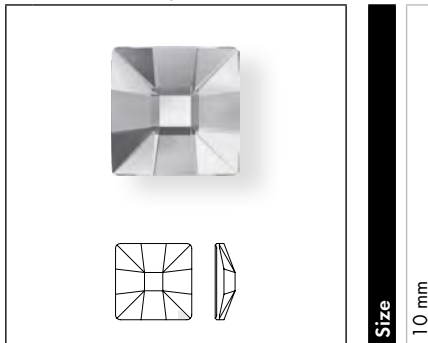

Size
10 mm

Crystal

Crystal M HF (001)

Colors

Plain Colors

Black Diamond M HF (215)

Crystal Effects

Transparent Effects

Crystal Golden Shadow M HF (001 GSHA)

2493 Chessboard Flat Back

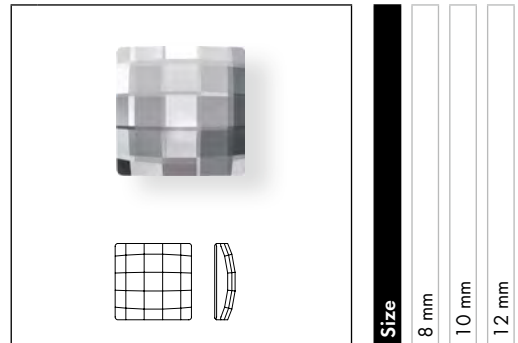

Size
8 mm
10 mm
12 mm

Crystal

Crystal M HF (001)

Crystal Effects

Crystal AB M HF (001 AB)

Crystal Patina Effect

Crystal Black Patina M HF (001 BLAPA)

Crystal Gold Patina M HF (001 GOLPA)

Crystal Rose Patina M HF (001 ROSPA)

Crystal Silver Patina M HF (001 SILPA)

Crystal White Patina M HF (001 WHIPA)

TRANSFERS

2494 Starlet Flat Back

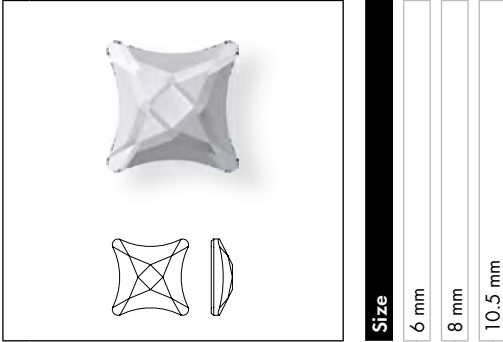

Size
6 mm
8 mm
10.5 mm

Crystal	
Crystal M HF (001)	■ ■ ■
Colors	
Plain Colors	
Jet M HF (280)	■ ■ ■
Light Siam M HF (227)	■ ■ ■
Light Turquoise M HF (263)	■ ■ ■
Smoky Mauve M HF (265)	■ ■ ■
Crystal Effects	
Transparent Effects	
Crystal AB M HF (001 AB)	■ ■ ■
Crystal Bermuda Blue M HF (001 BBL)	■ ■ ■
Crystal Golden Shadow M HF (001 GSHA)	■ ■ ■
Crystal Luminous Green M HF (001 LUMG)	■ ■ ■
Crystal Paradise Shine M HF (001 PARSH)	■ ■ ■
Crystal Silver Night M HF (001 SINI)	■ ■ ■

FLAT BACKS FOR TRANSFERS

2510 Baguette Flat Back

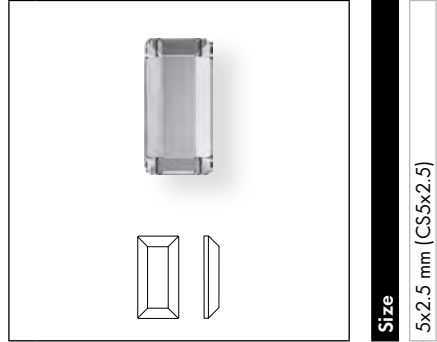

Size
5x2.5 mm (CS5x2.5)

Crystal	
Crystal M HF (001)	■
Colors	
Plain Colors	
Jet M HF (280)	■
Crystal Effects	
Transparent Effects	
Crystal AB M HF (001 AB)	■
Metallic Effects	
Crystal Light Chrome M HF (001 LTCH)	■
Color Effects	
Metallic Effects	
Jet Hematite M HF (280 HEM)	■

TRANSFERS

2540 Curvy Flat Back

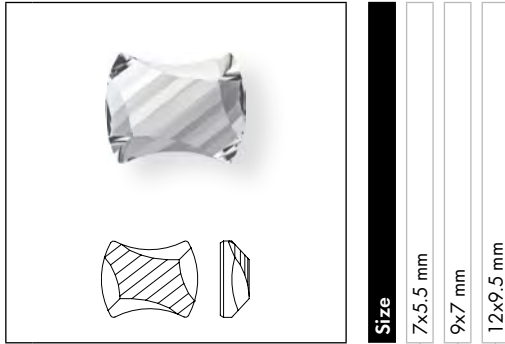

Size
7x5.5 mm
9x7 mm
12x9.5 mm

Crystal

Crystal M HF (001)

Colors

Plain Colors

Jet M HF (280)

Light Siam M HF (227)

Light Turquoise M HF (263)

Smoky Mauve M HF (265)

Rose Peach M HF (262)

Crystal Effects

Transparent Effects

Crystal AB M HF (001 AB)

Crystal Bermuda Blue M HF (001 BBL)

Crystal Golden Shadow M HF (001 GSHA)

Crystal Luminous Green M HF (001 LUMG)

Crystal Paradise Shine M HF (001 PARSH)

Crystal Silver Night M HF (001 SINI)

FLAT BACKS FOR TRANSFERS

2555 Cosmic Baguette Flat Back

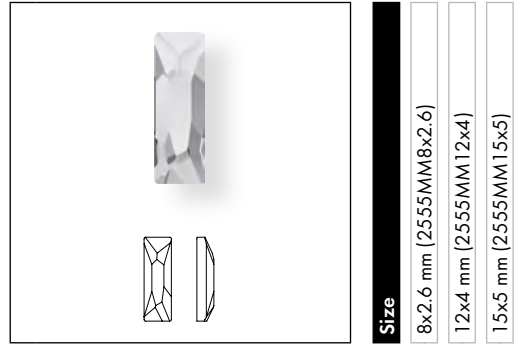

Size
8x2.6 mm (2555MM8x2.6)
12x4 mm (2555MM12x4)
15x5 mm (2555MM15x5)

Crystal

Crystal M HF (001)

Colors

Plain Colors

Jet M HF (280)

Crystal Effects

Transparent Effects

Crystal AB M HF (001 AB)

Crystal Golden Shadow M HF (001 GSHA)

Crystal Silver Shade M HF (001 SSHA)

2585 Graphic Flat Back



Size
8 mm

Crystal

Crystal M HF (001)

2610 Rectangle Flat Back

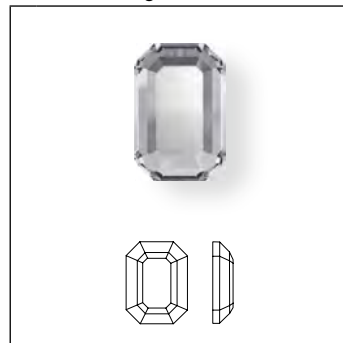

Size
6x4 mm (CS6x4)

Crystal

Crystal M HF (001)

2611 Solaris Flat Back

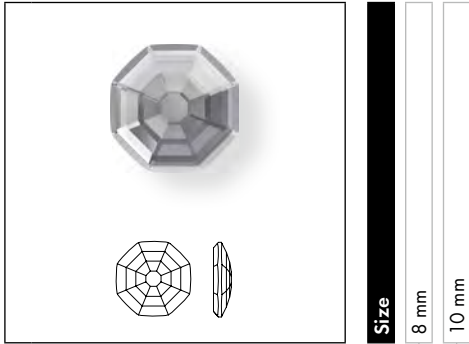

Crystal		
Crystal M HF (001)	■	■
Colors		
Plain Colors		
Jet M HF (280)	■	
Crystal Effects		
Transparent Effects		
Crystal AB M HF (001 AB)	■	■
Crystal Golden Shadow M HF (001 GSHA)	■	■
Crystal Silver Night M HF (001 SINI)	■	■

OCEAN MYSTERIES DESIGNED BY
CÉLINE COUSTEAU

Design Story: A love for the sea runs through her veins: Céline Cousteau is a celebrated filmmaker, humanitarian, and environmentalist, and, as it so happens, the granddaughter of legendary ocean explorer Jacques Yves Cousteau. She presents her first ever crystal designs for Swarovski, inspired by one of her favorite places, the depths of the ocean. Taking inspiration from nature itself

and leaving its beauty unaltered, her stunningly life-like creatures are not only captivating and spellbinding, they also draw attention toward the mysterious, mostly unseen, and unexplored world beneath the ocean's surface on which all ocean life depends. These mysteries need to be protected for future generations, both above and below the water.

2612 Jelly Fish Flat Back partly frosted Hotfix

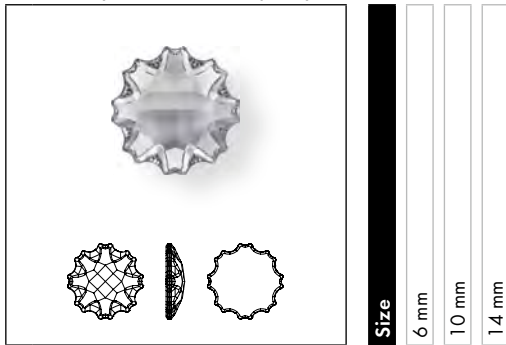

	6 mm	10 mm	14 mm
Crystal			
Crystal M HF (001)	■	■	■
Colors			
Plain Colors			
Blush Rose M HF (257)	■	■	■
Jet M HF (280)	■	■	■
Tanzanite M HF (539)	■	■	■
Opal Colors			
White Opal M HF (234)	■	■	■
Crystal Effects			
Transparent Effects			
Crystal AB M HF (001 AB)	■	■	■
Crystal Bermuda Blue M HF (001 BBL)	■	■	■
Crystal Blue Shade M HF (001 BLSH)	■	■	■
Crystal Golden Shadow M HF (001 GSHA)	■	■	■
Crystal Luminous Green M HF (001 LUMG)	■	■	■
Crystal Silver Night M HF (001 SINI)	■	■	■

TRANSFERS

2708 Molecule Flat Back

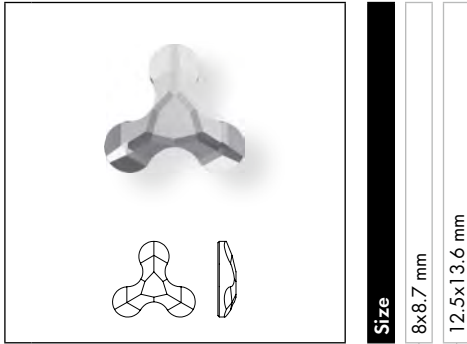

Size

8x8.7 mm

12.5x13.6 mm

Crystal

Crystal M HF (001)

Crystal Effects

Transparent Effects

Crystal AB M HF (001 AB)

FLAT BACKS FOR TRANSFERS

2711 Triangle Flat Back

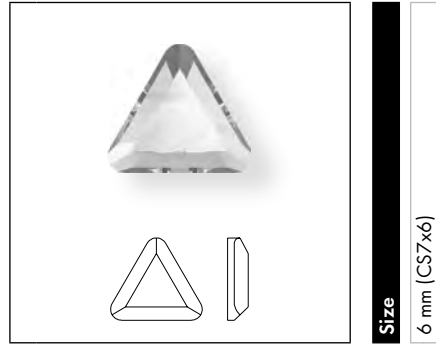

Size

6 mm (CS7x6)

Crystal

Crystal M HF (001)

Colors

Plain Colors

Jet M HF (280)

Crystal Effects

Transparent Effects

Crystal AB M HF (001 AB)

Color Effects

Metallic Effects

Jet Hematite M HF (280 HEM)

TRANSFERS

2714 Fan Flat Back Hoflix

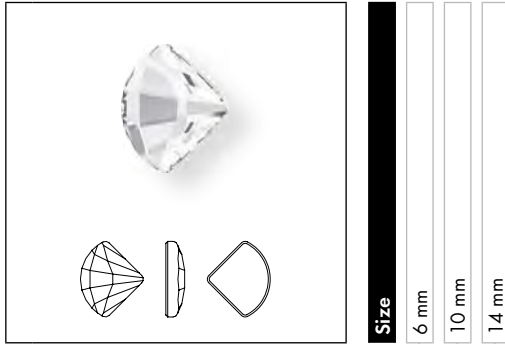

	6 mm	10 mm	14 mm
Crystal			
Crystal M HF (001)	■	■	■
Colors			
Plain Colors			
Blush Rose M HF (257)	■	■	■
Jet M HF (280)	■	■	■
Jonquil M HF (213)	■	■	■
Light Siam M HF (227)	■	■	■
Rose Peach M HF (262)	■	■	■
Crystal Effects			
Transparent Effects			
Crystal AB M HF (001 AB)	■	■	■
Crystal Blue Shade M HF (001 BLSH)	■	■	■
Crystal Golden Shadow M HF (001 GSHA)	■	■	■
Crystal Silver Night M HF (001 SINI)	■	■	■
Metallic Effects			
Crystal Metallic Sunshine M HF (001 METSH)	■	■	■
Crystal Scarabaeus Green*** M HF (001 SCGR)	■	■	■

FLAT BACKS FOR TRANSFERS

2728 Marguerite Flat Back

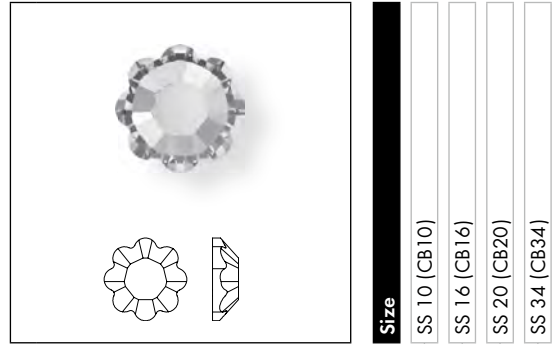

	SS 10 (CB10)	SS 16 (CB16)	SS 20 (CB20)	SS 34 (CB34)
Crystal				
Crystal M HF (001)	■	■	■	■
Crystal Effects				
Transparent Effects				
Crystal AB M HF (001 AB)	■	■	■	■

*** designed by Jean Paul Gaultier

TRANSFERS

2738 Triangle Alpha Flat Back

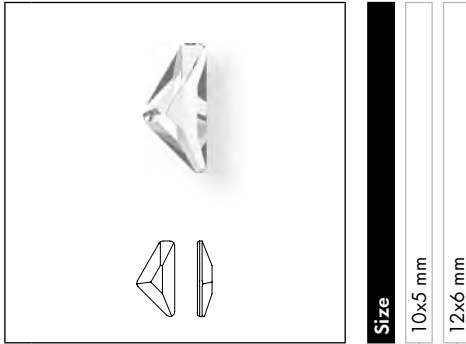

Size
10x5 mm
12x6 mm

- Crystal**
- Crystal M HF (001)
- Colors**
- Plain Colors**
- Blush Rose M HF (257)
- Jet M HF (280)
- Light Colorado Topaz M HF (246)
- Light Sapphire M HF (211)
- Light Siam M HF (227)
- Crystal Effects**
- Transparent Effects**
- Crystal AB M HF (001 AB)
- Crystal Golden Shadow M HF (001 GSHA)
- Crystal Silver Night M HF (001 SINI)
- Crystal Lacquer^{PRO}**
- Crystal Dark Grey HFT (001 L111S)
- Crystal Dark Red HFT (001 L108S)
- Crystal Ivory Cream HFT (001 L106S)

FLAT BACKS FOR TRANSFERS

2739 Triangle Beta Flat Back

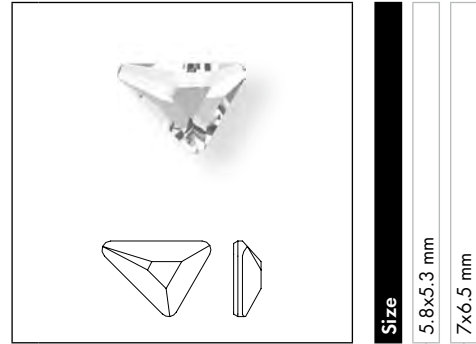

Size
5.8x5.3 mm
7x6.5 mm

- Crystal**
- Crystal M HF (001)
- Colors**
- Plain Colors**
- Blush Rose M HF (257)
- Jet M HF (280)
- Light Colorado Topaz M HF (246)
- Light Sapphire M HF (211)
- Light Siam M HF (227)
- Crystal Effects**
- Transparent Effects**
- Crystal AB M HF (001 AB)
- Crystal Golden Shadow M HF (001 GSHA)
- Crystal Silver Night M HF (001 SINI)
- Crystal Lacquer^{PRO}**
- Crystal Dark Grey HFT (001 L111S)
- Crystal Dark Red HFT (001 L108S)
- Crystal Ivory Cream HFT (001 L106S)

2740 Triangle Gamma Flat Back

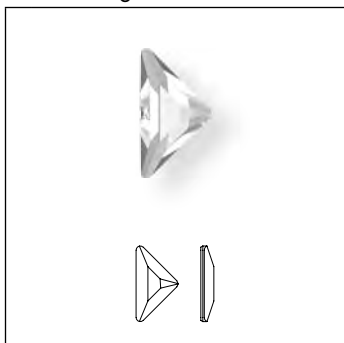

Size	8.3x8.3 mm	10x10 mm
-------------	------------	----------

Crystal

Crystal M HF (001)	<input type="checkbox"/>	<input type="checkbox"/>
--------------------	--------------------------	--------------------------

Colors

Plain Colors

Blush Rose M HF (257)	<input type="checkbox"/>	<input type="checkbox"/>
-----------------------	--------------------------	--------------------------

Jet M HF (280)	<input type="checkbox"/>	<input type="checkbox"/>
----------------	--------------------------	--------------------------

Light Colorado Topaz M HF (246)	<input type="checkbox"/>	<input type="checkbox"/>
---------------------------------	--------------------------	--------------------------

Light Sapphire M HF (211)	<input type="checkbox"/>	<input type="checkbox"/>
---------------------------	--------------------------	--------------------------

Light Siam M HF (227)	<input type="checkbox"/>	<input type="checkbox"/>
-----------------------	--------------------------	--------------------------

Crystal Effects

Transparent Effects

Crystal AB M HF (001 AB)	<input type="checkbox"/>	<input type="checkbox"/>
--------------------------	--------------------------	--------------------------

Crystal Golden Shadow M HF (001 GSHA)	<input type="checkbox"/>	<input type="checkbox"/>
---------------------------------------	--------------------------	--------------------------

Crystal Silver Night M HF (001 SINI)	<input type="checkbox"/>	<input type="checkbox"/>
--------------------------------------	--------------------------	--------------------------

Crystal Lacquer^{PRO}

Crystal Dark Grey HFT (001 L111S)	<input type="checkbox"/>	<input type="checkbox"/>
-----------------------------------	--------------------------	--------------------------

Crystal Dark Red HFT (001 L108S)	<input type="checkbox"/>	<input type="checkbox"/>
----------------------------------	--------------------------	--------------------------

Crystal Ivory Cream HFT (001 L106S)	<input type="checkbox"/>	<input type="checkbox"/>
-------------------------------------	--------------------------	--------------------------

TRANSFERS

2753¹ Edelweiss Flat Back

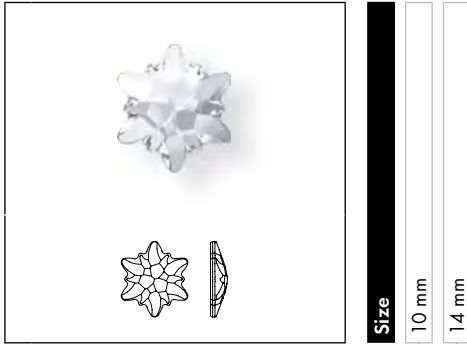

Size
10 mm
14 mm

- Crystal**
- Crystal M HF (001)
- Colors**
- Plain Colors**
- Amethyst M HF (204)
- Denim Blue M HF (266)
- Light Siam M HF (227)
- Vintage Rose M HF (319)
- Opal Colors**
- White Opal M HF (234)
- Crystal Effects**
- Transparent Effects**
- Crystal AB M HF (001 AB)
- Crystal Blue Shade M HF (001 BLSH)
- Crystal Golden Shadow M HF (001 GSHA)
- Crystal Luminous Green M HF (001 LUMG)
- Crystal Silver Night M HF (001 SINI)
- Metallic Effects**
- Crystal Metallic Sunshine M HF (001 METSH)

FLAT BACKS FOR TRANSFERS

2753/G¹ Edelweiss Flat Back partly frosted



Size
10 mm
14 mm

- Crystal**
- Crystal M HF (001)
- Crystal Effects**
- Transparent Effects**
- Crystal AB M HF (001 AB)
- Crystal Blue Shade M HF (001 BLSH)
- Crystal Golden Shadow M HF (001 GSHA)
- Crystal Luminous Green M HF (001 LUMG)
- Crystal Silver Night M HF (001 SINI)
- Metallic Effects**
- Crystal Metallic Sunshine M HF (001 METSH)

11 TRANSFERS

2770 Wing Flat Back

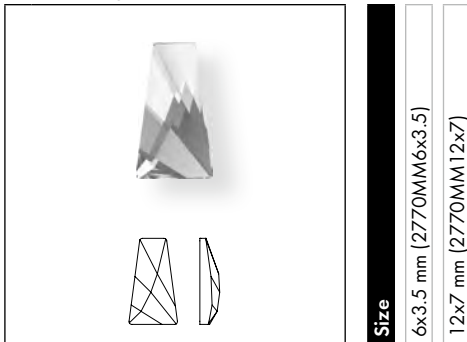

Size
6x3.5 mm (2770MM6x3.5)
12x7 mm (2770MM12x7)

- Crystal**
- Crystal M HF (001)
- Crystal Effects**
- Transparent Effects**
- Crystal AB M HF (001 AB)

2788 Wave Flat Back



Size
8 mm
10 mm

- Crystal**
- Crystal M HF (001)
- Crystal Effects**
- Transparent Effects**
- Crystal AB M HF (001 AB)

¹ Article 2753 and 2753/G is not available for Transfers Unlimited

DIAMOND LEAF¹

Swarovski and Giorgio Armani worked together to create an exclusive crystal called "Diamond Leaf". This Designer Edition has a fluid, organic shape reminiscent of a leaf.

Precision cut facets melt into the softness of a floating, sculptural form, contrasting strength and fragility, the timeless with the ethereal.

2797 Diamond Leaf Flat Back¹



Size

8x4 mm

Crystal

Crystal M HF (001)

¹ Article consists of Advanced Crystal

TRANSFERS

2798¹ Contour Flat Back

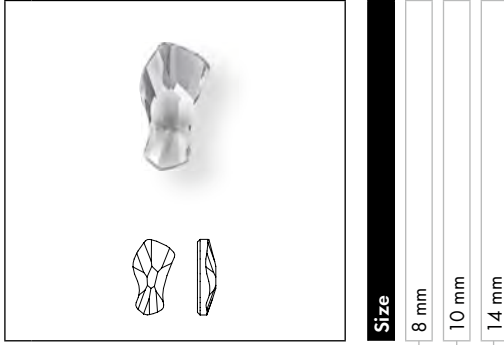

Size
8 mm
10 mm
14 mm

Crystal		
Crystal M HF (001)	■	■
Colors		
Plain Colors		
Graphite M HF (253)	■	■
Jet M HF (280)	■	■
Light Colorado Topaz M HF (246)	■	■
Light Silk M HF (261)	■	■
Opal Colors		
Light Grey Opal M HF (383)	■	■
White Opal M HF (234)	■	■
Crystal Effects		
Transparent Effects		
Crystal AB M HF (001 AB)	■	■
Crystal Blue Shade M HF (001 BLSH)	■	■
Crystal Golden Shadow M HF (001 GSHA)	■	■
Crystal Silver Night M HF (001 SINI)	■	■
Metallic Effects		
Crystal Iridescent Green M HF (001 IRIG)	■	■

FLAT BACKS FOR TRANSFERS

2808 Heart Flat Back

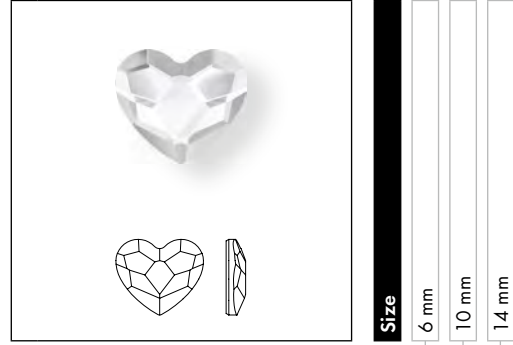

Size
6 mm
10 mm
14 mm

Crystal		
Crystal M HF (001)	■	■
Colors		
Plain Colors		
Denim Blue M HF (266)	■	■
Fuchsia M HF (502)	■	■
Jet M HF (280)	■	■
Light Siam M HF (227)	■	■
Crystal Effects		
Transparent Effects		
Crystal AB M HF (001 AB)	■	■
Crystal Golden Shadow M HF (001 GSHA)	■	■
Crystal Lacquer^{PRO}		
Crystal Powder Blue HFT (001 L104)	■	■
Crystal Powder Green HFT (001 L102)	■	■
Crystal Powder Rose HFT (001 L103)	■	■
Crystal Patina Effect		
Crystal Black Patina M HF (001 BLAPA)	■	■
Crystal Gold Patina M HF (001 GOLPA)	■	■
Crystal Rose Patina M HF (001 ROSPA)	■	■
Crystal Silver Patina M HF (001 SILPA)	■	■
Crystal White Patina M HF (001 WHIPA)	■	■

¹ Article 2798 is not available for Transfers Unlimited

TRANSFERS

2813 Moon Flat Back Hotfix

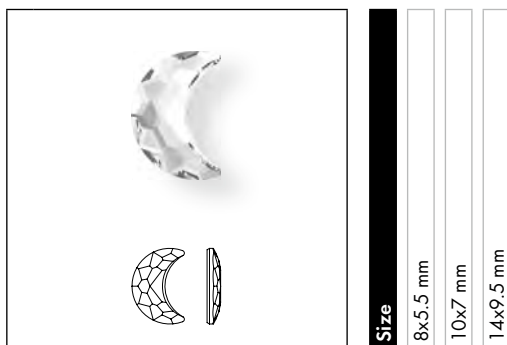

Crystal	8x5.5 mm	10x7 mm	14x9.5 mm
Crystal M HF (001)	■	■	■
Colors			
Plain Colors			
Blush Rose M HF (257)	■	■	■
Jet M HF (280)	■	■	■
Light Colorado Topaz M HF (246)	■	■	■
Light Siam M HF (227)	■	■	■
Crystal Effects			
Transparent Effects			
Crystal AB M HF (001 AB)	■	■	■
Crystal Golden Shadow M HF (001 GSHA)	■	■	■
Crystal Luminous Green M HF (001 LUMG)	■	■	■
Crystal Moonlight M HF (001 MOL)	■	■	■
Crystal Silver Night M HF (001 SINI)	■	■	■
Crystal Effects			
Metallic Effects			
Crystal Metallic Sunshine M HF (001 METSH)	■	■	■
Crystal Scarabaeus Green*** M HF (001 SCGR)	■	■	■

FLAT BACKS FOR TRANSFERS

2817 Star Flat Back

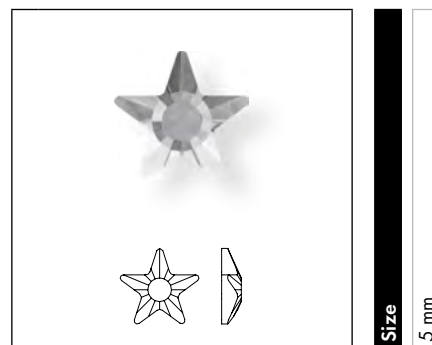

Crystal	5 mm
Crystal M HF (001)	■
Colors	
Plain Colors	
Jet M HF (280)	■
Crystal Effects	
Transparent Effects	
Crystal AB M HF (001 AB)	■
Color Effects	
Metallic Effects	
Jet Hematite M HF (280 HEM)	■

*** designed by Jean Paul Gaultier

TRANSFERS

2855 Butterfly Flat Back

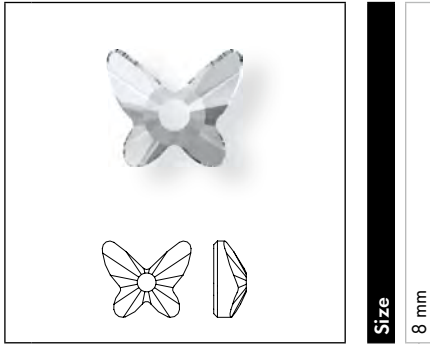

- Crystal**
- Crystal M HF (001)
- Colors**
- Plain Colors**
- Denim Blue M HF (266)
- Jet M HF (280)
- Crystal Effects**
- Transparent Effects**
- Crystal AB M HF (001 AB)
- Crystal Golden Shadow M HF (001 GSHA)
- Crystal Silver Night M HF (001 SINI)

FLAT BACKS FOR TRANSFERS

2858 Bow Tie Flat Back

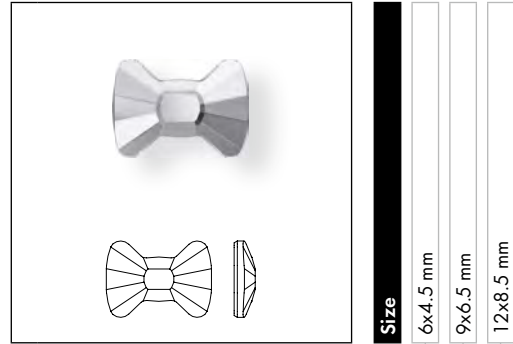

- Crystal**
- Crystal M HF (001)
- Colors**
- Plain Colors**
- Jet M HF (280)
- Crystal Effects**
- Transparent Effects**
- Crystal AB M HF (001 AB)
- Crystal Golden Shadow M HF (001 GSHA)
- Crystal Luminous Green M HF (001 LUMG)
- Crystal Paradise Shine M HF (001 PARSH)
- Crystal Silver Night M HF (001 SINI)
- Crystal Lacquer^{PRO}**
- Crystal Powder Blue HFT (001 L104)
- Crystal Powder Rose HFT (001 L103)

CREATION STONES

2080/4 Cabochon

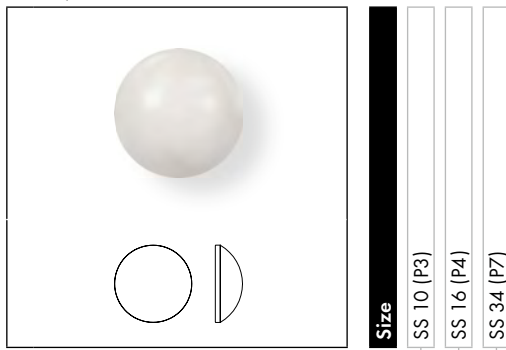

Colors	SS 10 (P3)	SS 16 (P4)	SS 34 (P7)
Plain Colors			
● Jet M HF (280)	■	■	■
Crystal Pearl Colors			
● Crystal Bronze Pearl HF (001 295)	■		
● Crystal Creampearl HF (001 291)	■	■	■
● Crystal Dark Grey Pearl HF (001 617)	■		
● Crystal Light Grey Pearl HF (001 616)	■		
● Crystal Rosaline Pearl HF (001 294)	■	■	■
● Crystal White Pearl HF (001 650)	■	■	■
Crystal Effects			
Transparent Effects			
● Crystal Golden Shadow HF (001 GSHA)	■	■	■
● Crystal Nacre HF (001 191)	■	■	■
Metallic Effects			
● Crystal Light Chrome HF (001 LTCH)	■	■	■
● Crystal Scarabaeus Green*** HF (001 SCGR)	■	■	■
Crystal Lacque^{PRO}			
● Crystal Powder Blue HFT (001 L104)	■	■	■
● Crystal Powder Green HFT (001 L102)	■	■	■
● Crystal Powder Rose HFT (001 L103)	■	■	■
Crystal Color Effects			
Metallic Effects			
● Jet Hematite M HF (280 HEM)	■	■	■

*** designed by Jean Paul Gaultier

TRANSFERS

FLAT BACKS FOR TRANSFERS

CRYSTAL DIAMONDS FOR TRANSFERS

1360 (with art. 1028 XILION Chaton)

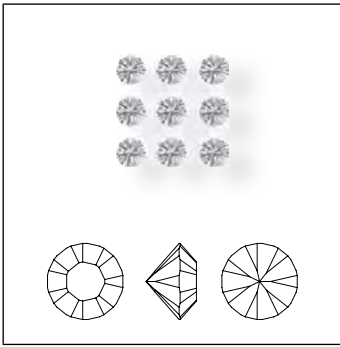

1360 (with art. 1088 XIRIUS Chaton)

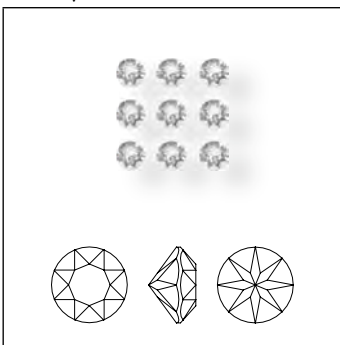







































	Size	PP 7 (PP7 with art. 1028 XILION Chaton)	PP 12 (PP12 with art. 1028 XILION Chaton)	PP 17 (PP17 with art. 1088 XIRIUS Chaton)
1360 ¹				
Crystal				
Crystal (001)		■	■	■
Colors				
Plain Colors				
Black Diamond (215)		■	■	■
Jet (280)		■	■	■
Light Colorado Topaz (246)		■	■	■
Light Rose (223)		■	■	■
Light Siam (227)		■	■	■
Rose (209)		■	■	■
Sapphire (206)		■	■	■
Crystal Effects				
Transparent Effects				
Crystal AB (001 AB)		■	■	■

¹ The article is only available within a Transfer, not as loose stone

TRANSFERS

FLAT BACKS FOR TRANSFERS

METALLICS

	3490 3490/006 (M2)		3490 3490/008 (M8)		3490 3490/002 (M10x3)
	3490 3490/012 (M2.5)		3490 3490/009 (MZ8)		3490 3490/010 (M7x3)
	3490 3490/300 (M3)		3490 3490/007 (M10)		3490 3490/003 (MST)
	3490 3490/400 (M4)		3490 3490/001 (M7x7)		3490 3490/005 (M12x6)
	3490 3490/600 (M6)		3490 3490/011 (M3x3)		3490 3490/013 (M9x4)
	Gold ¹ brushed (081)		Silver brushed (082)		Gun metal brushed (086)
	Gold ¹ polished (091)		Silver polished (092)		Gun metal polished (096)
	Bronze brushed (084)		Copper brushed (080)		Black polished (070)
	Bronze polished (094)		Copper polished (090)		Blue brushed (071)
	Signal White (R 9003 ²)		Traffic Red (R 3020 ²)		Azure Blue (R 5009 ²)
	Grey Beige (R 1019 ²)		Blue Lilac (R 4005 ²)		Jet Black (R 9005 ²)
	Water Blue (R 5021 ²)		Red Brown (R 8012 ²)		Sapphire (R 5003 ²)
	Fern Green (R 6025 ²)		Dark Purple (R 4007 ²)		

¹ Golden colored

² Color tones according to the RAL colors.

TRANSFERS

ARTICLE EXPLANATION

12 906 F/W 2013/14



C 001/215/001/280HEM/001SSHA/215
E S3/S3/S6/S6/S6/S6
S ~71x100
M 12 PCS **40%**

13 033 S/S 2015

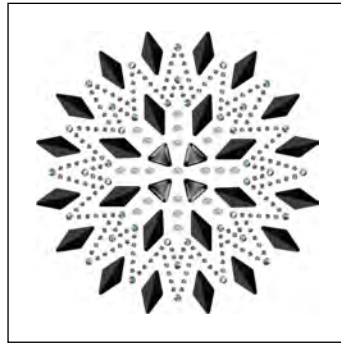

C 070-001LTCH/280HEM/215/001IRIG
E M12x6-P3/CS7x6/S3/S6
S ~74x74
M 12 PCS **50%**

12 906	C	E	S	M	40%
Article number	Color assortment	Elements	Motif size in mm	Minimum order quantity in pieces (PCS)	% of actual size
	For further details, please refer to the color and product charts at the beginning of this chapter. Color code 1 (001) corresponds to element 1 (S3); color code 2 (215) corresponds to element 2 (S3) etc.	For details, of stone sizes and element codes, please refer to the color and product charts at the beginning of this chapter.			
13 033	C	E	S	M	50%
Article number	Color assortment	Elements	Motif size in mm	Minimum order quantity in pieces (PCS)	% of actual size
	For further details, please refer to the color and product charts at the beginning of this chapter. Color code 1 (070-001LTCH) corresponds to element 1 (M12x6-P3); color code 2 (280HEM) corresponds to element 2 (CS7x6) etc. Metallics are separated from crystal colors with hyphens.	For details of stone sizes and element codes, please refer to the color and product charts at the beginning of this chapter. Codes for Metallics are separated from crystals with hyphens.			

TRANSFERS

ORDERING EXAMPLE & PRODUCT VARIETY EXPLANATION

13 033	070-001LTCH	280HEM
Article number	Crystal color corresponding to element 1; color of the most frequently used element in the motif Please see the respective product charts at the beginning of this chapter for all available reference codes.	Crystal color corresponding to element 2; color of the second most frequently used element in the motif

TRANSFERS UNLIMITED

With **Transfers Unlimited**, Swarovski presents a spectacular new production technology that opens up an unprecedented range of motif designs. Up to 18 different elements – crystals, colors, sizes, and shapes – can be combined in a single motif, doubling design possibilities and offering stunning 3D surfaces, long rows, and even “floating” effects. With a tight compound that has reduced

the distance between elements to a minimum, **Transfers Unlimited** also offers the highest setting quality on the market.

The Flat Back assortment is the same as our existing standard transfers.

ARTICLE EXPLANATION

13 146

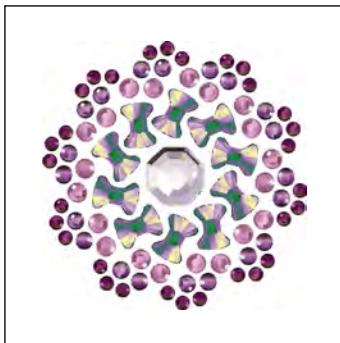

C	001/001PARSH/001LISH/001ANTP/212
E	2611MM8/2858MM6x4.5/S6/S8/S10
S	~35x36
M	55 PCS 100%

13 147

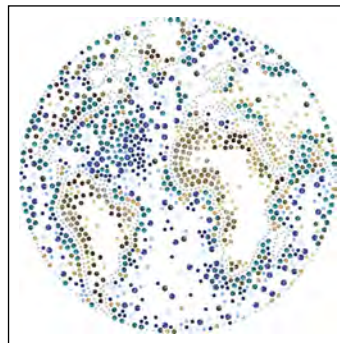

C	001617/001PBLUHFT/001PBLUHFT/001/243/001LUMG/202/246/220/550/263/229/263/001MLGLD/284/206
E	P3/P3/P4/S5/S6/S6/S6/S8/S8/S8/S8/S10/S10/S10/S10/S12
S	~168x167
M	2 PCS 25%

11 TRANSFERS

13 146	C	E	S	M	100%
Article number	Color assortment	Elements	Motif size in mm	Minimum order quantity in pieces (PCS)	% of actual size
	,For further details, please refer to the color and product charts at the beginning of this chapter. Color code 1 (001) corresponds to element 1 (2611MM8); color code 2 (001 PARSH) corresponds to element 2 (2858MM6x4.5) etc.	For details of stone sizes and element codes, please refer to the color and product charts at the beginning of this chapter.			

TRANSFERS

TRANSFERS UNLIMITED

13 147	C	E	S	M	25%
Article number	Color assortment	Elements	Motif size in mm	Minimum order quantity in pieces (PCS)	% of actual size
	For further details, please refer to the color and product charts at the beginning of this chapter. Color code 1 (001617) corresponds to element 1 (P3); color code 2 (001PBLUHFT) corresponds to element 2 (P3) etc. Metallics are separated from crystal colors by hyphens.	For details of stone sizes and element codes, please refer to the color and product charts at the beginning of this chapter. Codes for Metallics are separated from crystals by hyphens.			

ORDERING EXAMPLE & PRODUCT VARIETY EXPLANATION

13 146	001	001PARSH	001LISH	001ANTP	212
Article number	Crystal color corresponding to element 1; color of the most frequently used element in the motif	Crystal color corresponding to element 2; color of the second most frequently used element in the motif	Crystal color corresponding to element 3; color of the third most frequently used element in the motif	Crystal color corresponding to element 4; color of the fourth most frequently used element in the motif	Crystal color corresponding to element 5; color of the fifth most frequently used element in the motif
	Please see the respective product charts at the beginning of this chapter for all available reference codes.				

STANDARD COLLECTION

Transfers are available in a range of sizes and motifs to suit a variety of segments. Numerous motifs and rows in all sizes and styles provide a creative pool of design ideas. The assortment is a balanced mix of large and small motifs in all price categories, as well as a good representation of all the different elements that can be used in Transfer motifs.

TRANSFERS

STANDARD COLLECTION



10 248

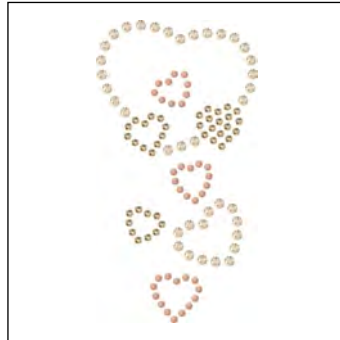

C 090-362/391
E M2-S6/S10
S ~43X80
M 55 PCS 50%

10 272

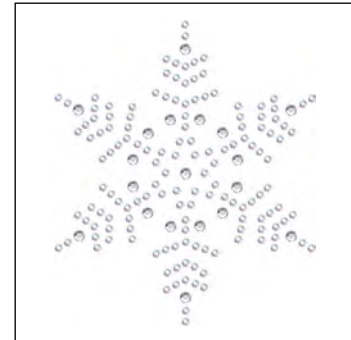

C 001AB/001
E S6/S10
S ~63x73
M 36 PCS 55%

10 368

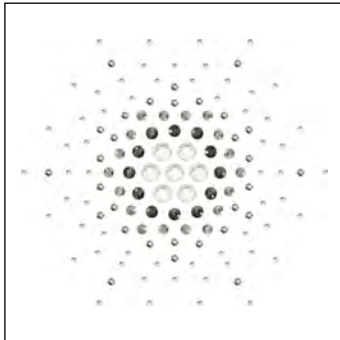

C 001/001SSHA/284/001SINI/001MOL
E S6/S10/S16/S20/S34
S ~116x100
M 16 PCS 35%

10 385

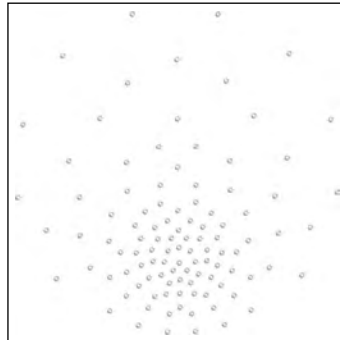

C 001AB
E S16
S ~230x230
M 4 PCS 19%

10 402

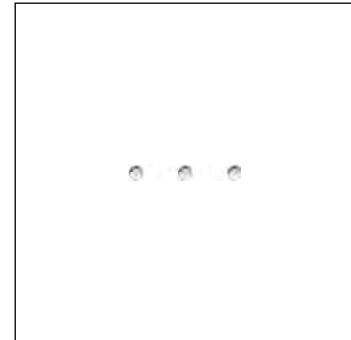

C 001
E S6
S ~982x2 (153 SEG/ROW)
M 18 ROWS 100%

10 403

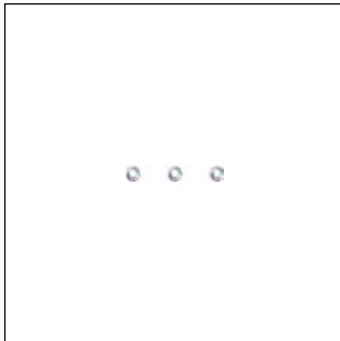

C 001AB
E S6
S ~987x2 (180 SEG/ROW)
M 18 ROWS 100%

10 405



C 001SSHA
E S10
S ~984x3 (152 SEG/ROW)
M 16 ROWS 100%

10 406

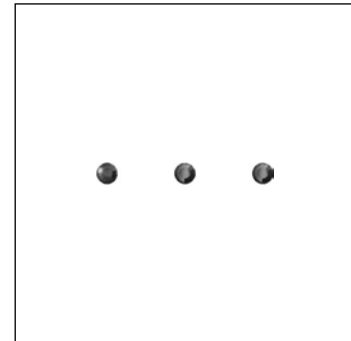

C 001SINI
E S10
S ~979x3 (99 SEG/ROW)
M 15 ROWS 100%

10 408

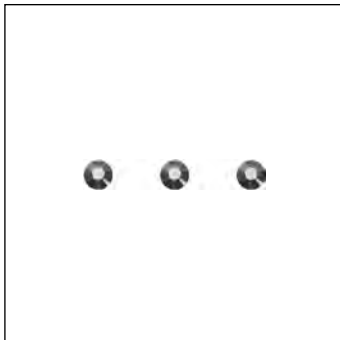

C 280HEM
E S16
S ~980x4 (98 SEG/ROW)
M 12 ROWS 100%

10 409



C 001GSHA
E CS8x4
S ~988x4 (49 SEG/ROW)
M 14 ROWS 80%

10 411



C 001BRSH
E S16
S ~979x4 (151 SEG/ROW)
M 12 ROWS 100%

TRANSFERS

STANDARD COLLECTION

10 412

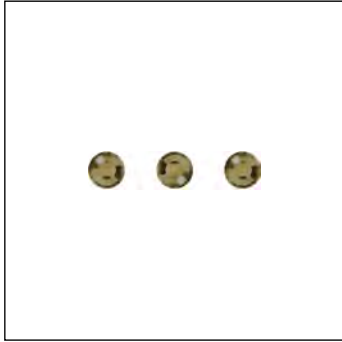

C	001MLGLD
E	S20
S	~974x5 (116 SEG/ROW)
M	12 ROWS
	100%

10 413

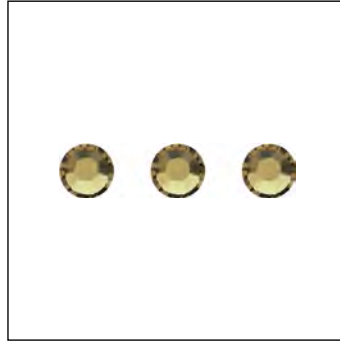

C	001GSHA
E	S34
S	~979x7 (82 SEG/ROW)
M	9 ROWS
	100%

10 980

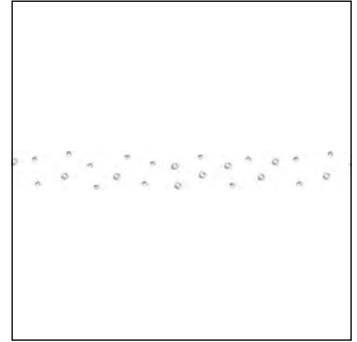

C	001/001AB
E	S6/S10
S	~979x15 (10 SEG/ROW)
M	10 ROWS
	35%

10 993

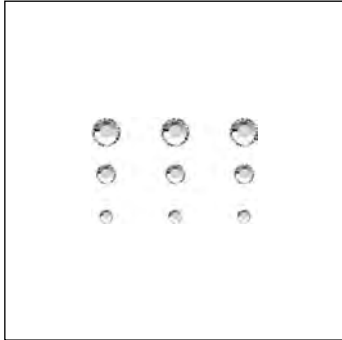

C	001/001/001
E	S6/S10/S16
S	~980x14 (109 SEG/ROW)
M	10 ROWS
	100%

11 082



C	001/234
E	S8/S10
S	~75x73
M	39 PCS
	50%

11 094

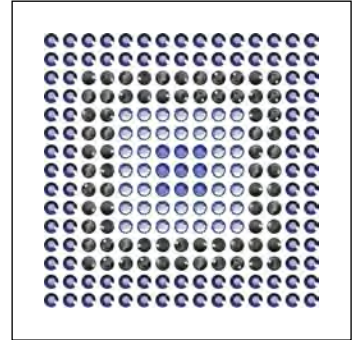

C	206SAT/001SINI/211/206
E	S10/S10/S10/S10
S	~52x52
M	48 PCS
	70%

11 167

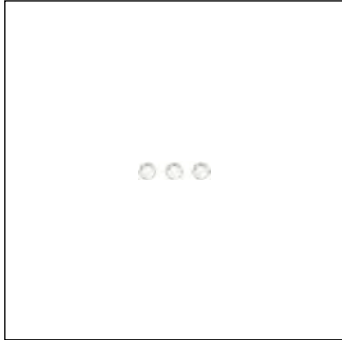

C	001MOL
E	S8
S	~982x2 (281 SEG/ROW)
M	18 ROWS
	100%

11 473

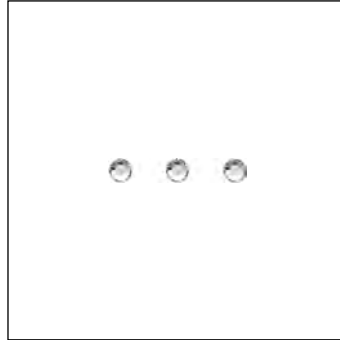

C	001
E	S12
S	~978x3 (131 SEG/ROW)
M	14 ROWS
	100%

11 494

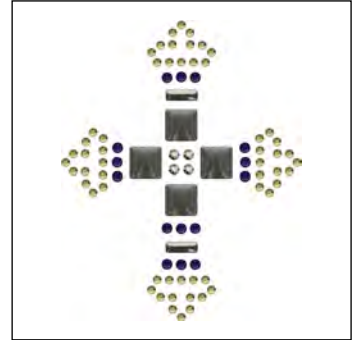

C	086/096-001GSHA/277/001SSHA
E	M7x7/M7x3-S6/S8/S8
S	~53x66
M	64 PCS
	60%

11 557



C	246/001AB
E	PP7/S6
S	~22x62
M	28 PCS
	60%

11 609

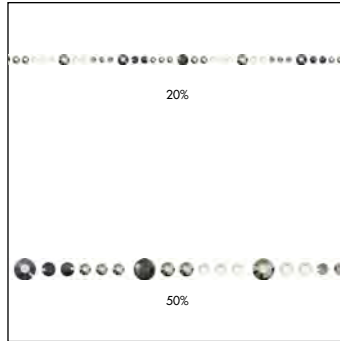

C	001SSHA/284/001MOL/001SINI/001SSHA/001MOL/280HEM/001SSHA/001SINI
E	S16/S16/S16/S20/S20/S20/S34/S34/S34
S	~938x7 (8 SEG/ROW)
M	9 ROWS

11 633

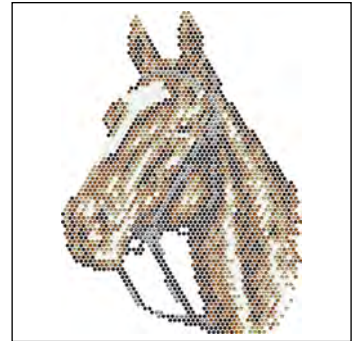

C	220/286/001GSHA/001MOL/280/280HEM/001COS
E	S6/S6/S6/S6/S6/S6/S6
S	~127x170
M	7 PCS
	25%

TRANSFERS

STANDARD COLLECTION

11 759

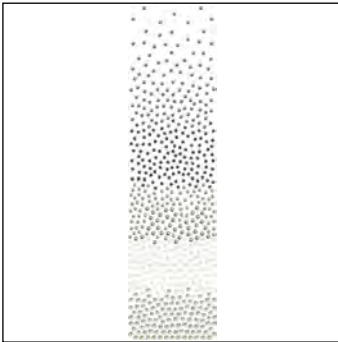

C 001SINI/280HEM/001SSHA/001MOL/
234/001SSHA/234/001MOL
E S6/S6/S6/S8/S8/S10/S10
S ~51x192
M 16 PCS 23%

11 786



C 213SAT/550/001MLGLD/001GSHA
E S6/S6/S6/S6
S ~124x170
M 10 PCS 25%

12 116

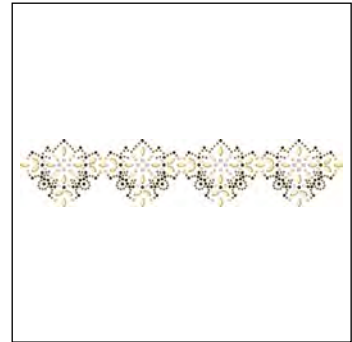

C 001GSHA/001/001MLGLD/001BRSH/
001GSHA/220/391
E CS8x4/CS3x3/S6/S8/S10/S10/S12
S ~266x56
M 9 PCS 16%

18 335

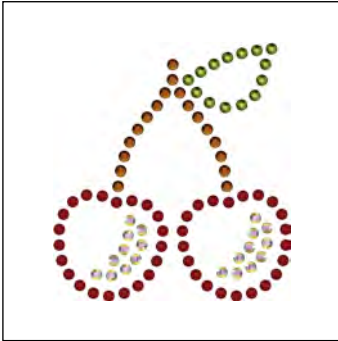

C 227/001TRAHFT/220/228
E S6/S6/S6/S6
S ~39x43
M 80 PCS 80%

18 585



C 001/234/001GSHA/001
E S6/S8/S10/S12
S ~60x60
M 42 PCS 60%

13 275



C R4005/R5009-001AB/227/231/
001GSHA/502
E M2/M2-S5/S5/S6/S6/S6
S ~104x23
M 52 PCS 40%

13 276

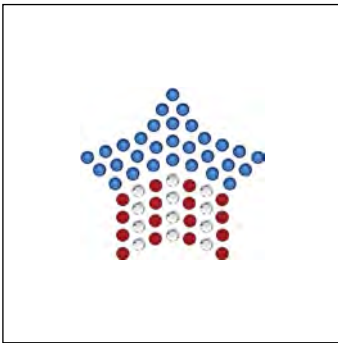

C 243/227/001
E S5/S5/S5
S ~24x23
M 180 PCS 100%

13 277



C 229/243/215/228/001SCGR
E S5/S5/S5/S6/S6
S ~53x88
M 39 PCS 46%

13 278

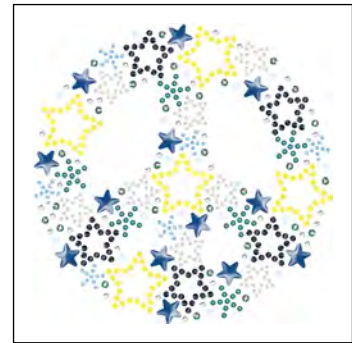

C R5009-001PBLUHFT/001AB/202/229/
001/231/253/001SCGR
E MST-P3/S3/S3/S5/S5/S6/S6/S8
S ~99x99
M 8 PCS 40%

TRANSFERS

STANDARD COLLECTION

13 279

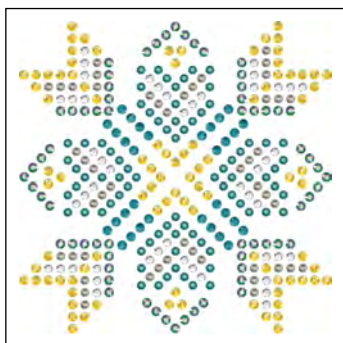

C 229/001/215/001METSH/001SCGR/263
 E S5/S5/S5/S6/S6/S6
 S ~62x62
 M 39 PCS 66%

13 280

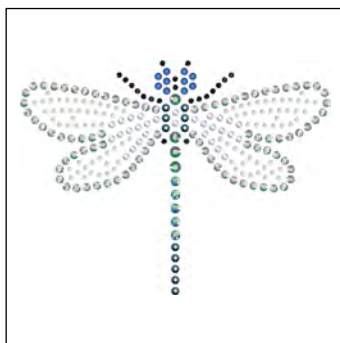

C 001AB/280/001AB/243/001PARSH/
 001METBL/001IRIG/001SCGR
 E S3/S3/S5/S5/S6/S6/S8/S10
 S ~75x56
 M 21 PCS 55%

13 281

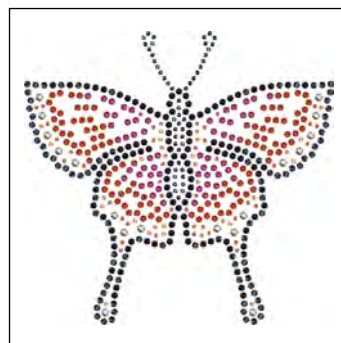

C 001ROGL/280HEM/280/236/253/
 502/001SSHA
 E S3/S3/S6/S6/S6/S6/S8
 S ~93x88
 M 10 PCS 44%

13 282



C 223/001
 E PP7/PP7
 S ~42x80
 M 6 PCS 52%

13 283

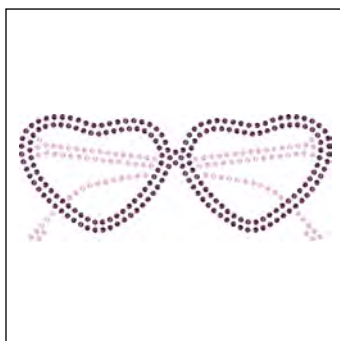

C 204/223
 E S3/S3
 S ~77x31
 M 36 PCS 54%

13 284

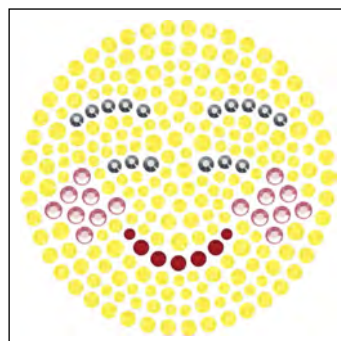

C 231/227/231/280HEM/231/227/
 280HEM/223/231
 E S6/S6/S8/S8/S10/S10/S10/S12/S12
 S ~73x71
 M 20 PCS 78%

13 285

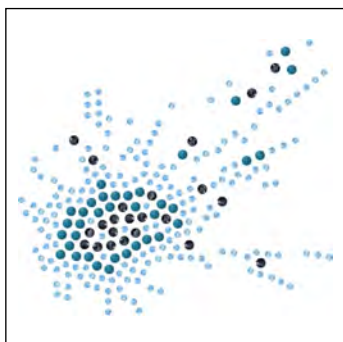

C R5009-202/253
 E M2-S3/S6
 S ~63x55
 M 28 PCS 66%

13 286



C 223/209/327
 E S3/S8/S8
 S ~81x62
 M 20 PCS 50%

13 287

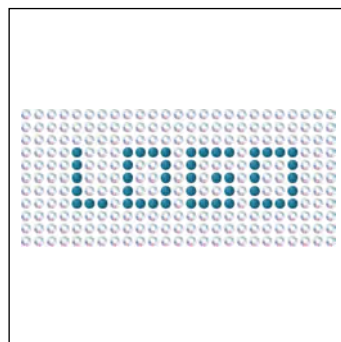

C R5009-001AB
 E M2-S6
 S ~59x26
 M 84 PCS 70%

TRANSFERS

STANDARD COLLECTION

13 288

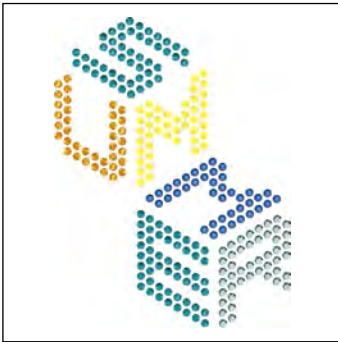

C 263/360/231/243/259
 E S6/S6/S6/S6/S6
 S ~57x75
 M 44 PCS 55%

13 289



C 001LTCH
 E S6
 S ~231x39
 M 16 PCS 18%

13 290

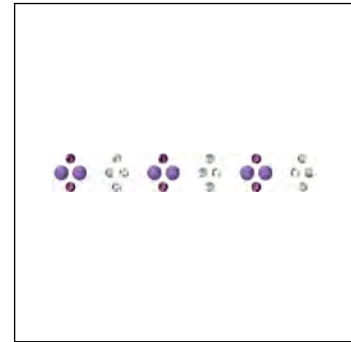

C R4005-001SSHA/204
 E M2-S3/S3
 S ~506x5 (41 seg/row)
 M 15 ROWS 100%

13 291

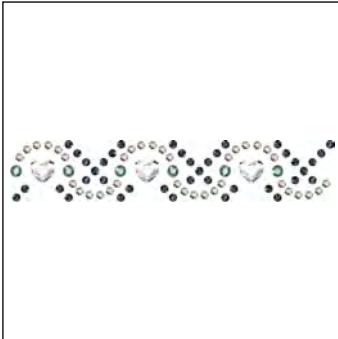

C 001/253/001SSHA/001SCGR
 E 2808MM60/S6/S6/S10
 S ~979x15 (39 seg/row)
 M 9 ROWS 55%

13 293

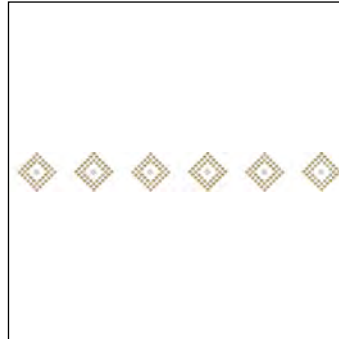

C R1019/R9003-001/001GSHA/246
 E M2/M7x7-CS3x3/S6/S6
 S ~976x22 (15 seg/row)
 M 7 ROWS 23%

13 294

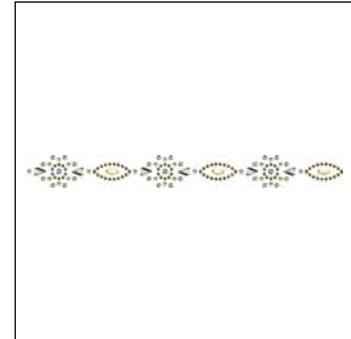

C 001LTCH/001GSHA/001DOR/
 001GSHA/215/001SCGR
 E CS8x5/CS8x4/S6/S8/S10/S12
 S ~951x19 (15 seg/row)
 M 7 ROWS 22%

13 295

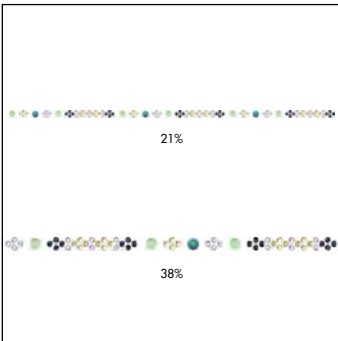

C 001PGRHFT/001SCGR/
 265/213/253/246
 E P4/P4/S6/S6/S6/S6
 S ~967x4 (14 seg/row)
 M 12 ROWS

13 298

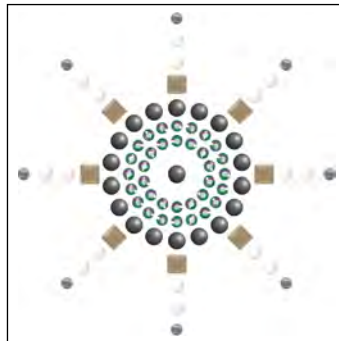

C 086/R9003/R1019-001617/001SCGR
 E M2/M2,5/M3x3-P3/S6
 S ~52x53
 M 48 PCS 80%

13 300

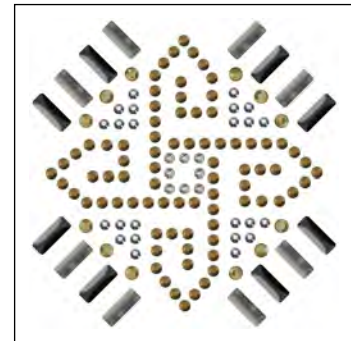

C 086/070-280HEM/215/001DOR/
 001MLGLD
 E M7x3/M7x3-S5/S5/S6/S8
 S ~50x51
 M 48 PCS 80%

TRANSFERS

STANDARD COLLECTION

13 301

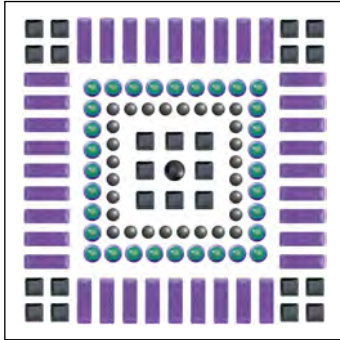

C R4005-001617/001SCGR/280HEM/253
 E M10x3-P3/P4/CS4x4/S20
 S ~66x67
 M 24 PCS 60%

13 302



C 084/R1019/R9005-280HEM/001GSHA
 E M3x3/M7x3/M12x6-CS5x2,5/CS4x4
 S ~80x31
 M 50 PCS 50%

13 303

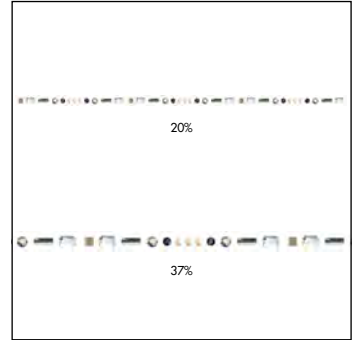

C R1019/096-001GSHA/001/253/
 001SSHA
 E M3x3/M7x3-P3/CS6x4/S12/S16
 S ~956x4 (13 seg./row)
 M 12 ROWS

13 304

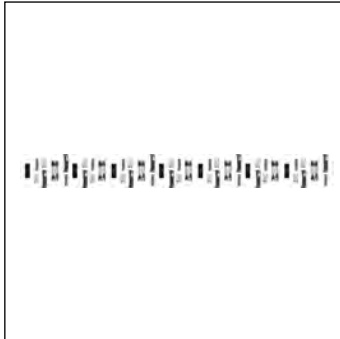

C 096/092-001/280/001SSHA
 E M10x3/M7x3-CS5x2,5/2555MM8x2,6/
 2555MM12x4
 S ~174x19
 M 35 PCS 23%

13 305

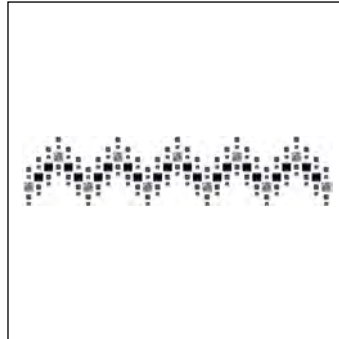

C R9005-253/280HEM/001BLAPA
 E M7x7-CS3x3/CS4x4/2493MM8
 S ~253x56
 M 9 PCS 16%

13 306



C 280HEM/280/001GSHA/280HEM/
 001MLGLD/001SCGR/253/204
 E CS5x2/CS5x2,5/CS4x4/S6/S6/S8/
 S10/S12
 S ~48x83
 M 39 PCS 50%

13 307



C 001617/280HEM/001/001SINI/
 001LTCH/280HEM/001SSHA/215
 E P3/CS8x4/2037MM8/2611MM8/
 S6/S6/S6/S6
 S ~133x84
 M 6 PCS 32%

13 308



C R1019-001GSHA/001MLGLD/253
 E M2-P3/S6/S6
 S ~82x127
 M 16 PCS 33%

13 309

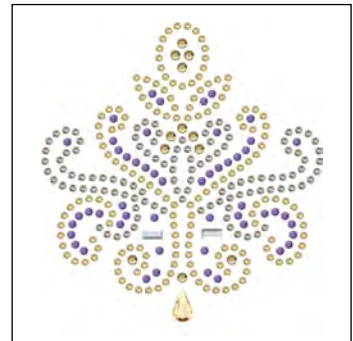

C R4005-001GSHA/001LTCH/246/
 215/001GSHA
 E M2-CS8x5/CS5x2,5/S5/S5/S8
 S ~67x71
 M 39 PCS 56%

13 321

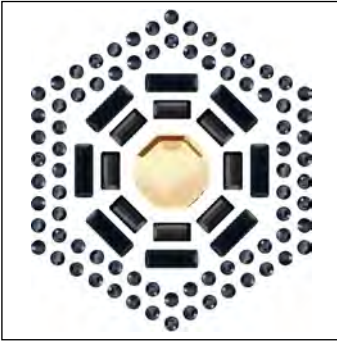

C	R9005-280HEM/001GSHA/253
E	M7x3-CS5x2,5/2611MM10/S6
S	~37x43
M	84 PCS
	100%

11 461

14

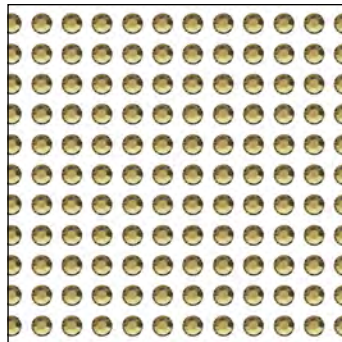

C	001GSHA
E	S10
S	~478x210
M	2 PCS
	100%

TRANSFERS

STANDARD COLLECTION



STANDARD COLLECTION
TRANSFERS UNLIMITED

13 141

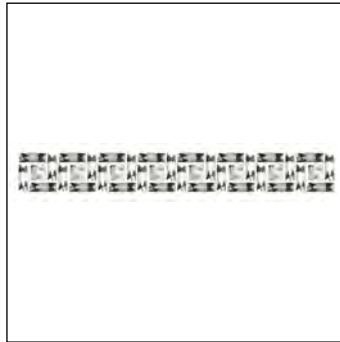

C	001/001/001SSHA
E	2493MM8/2555MM15x5/ 2555MM15x5
S	~173x21
M	13 PCS 24%

13 142

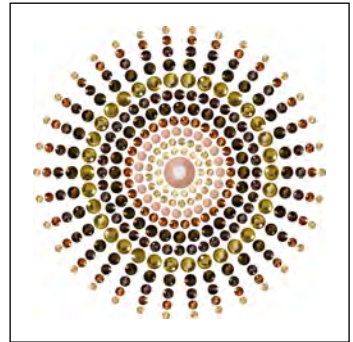

C	090/090-246/001GSHA/001COP/220/ 001BRSH/001DOR
E	M2.5/M8-S6/S6/S8/S10/S12/S16
S	~74x74
M	10 PCS 52%

13 143



C	001SINI/001/001SSHA/234/001SINI/ 215/280HEM/001/001SINI/215/ 001SSHA/001SSHA/001SINI/215/ 280HEM/001SINI/280HEM
E	2494MM6/S6/S6/S6/S8/S8/S8/S8/ S10/S10/S10/S12/S12/S12/S16/ S16/S20
S	~52x75
M	18 PCS 55%

13 144



C	094-001/001GSHA/001AB/001AB/ 001GSHA/234
E	M12x6-CS8x5/CS8x4/CS3x3/S8/S8/S10
S	~210x29
M	12 PCS 20%

13 146

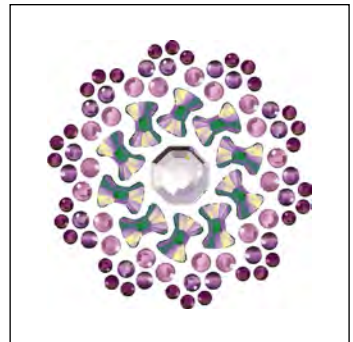

C	001/001PARSH/001LISH/001ANTP/212
E	2611MM8/2858MM6x4.5/S6/S8/S10
S	~35x36
M	55 PCS 100%

13 147

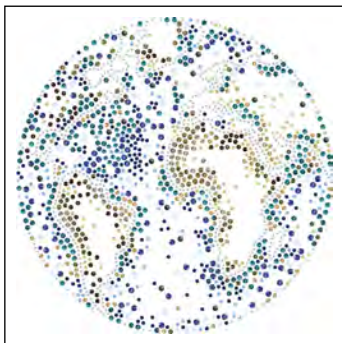

C	001617/001PBLUHFT/001PBLUHFT/001/ 243/001LUMG/202/246/220/550/263/ 229/263/001MLGLD/284/206
E	P3/P3/P4/S5/S6/S6/S6/S8/S8/S8/S8/ S10/S10/S10/S10/S12
S	~168x167
M	2 PCS 25%

13 148



C	091/094-001295/001GSHA/001GSHA/ /280HEM/001GSHA/001MLGLD/ 319/001GSHA/001AB/001ROGL/ 220/234/319
E	M2/M3-P3/P3/CS3x3/2817MM5/S3/ S6/S6/S6/S6/S6/S8/S10/S12
S	~41x212
M	9 PCS 20%

13 311

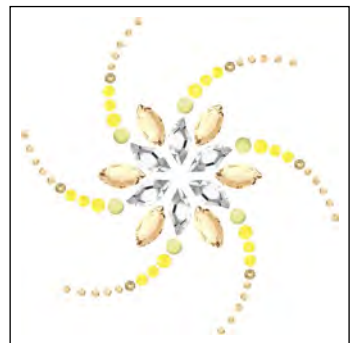

C	01GSHA/001/001GSHA/246/231/ 231/001PYELHFT
E	CS8x4/2797MM8x4/S3/S5/S6/S8/S10
S	~52x52
M	24 PCS 80%

TRANSFERS

STANDARD COLLECTION

13 312



C	001SSHA/001GSHA/001ITCH
E	2555MM8x2,6/25040MM9x7/S6
S	~112x45
M	10 PCS
	36%

13 313



C	001AB/280HEM
E	CS7x6/CS7x6
S	~22x22
M	72 PCS
	100%

13 314



C	001BLAPA/001SSHA/001
E	2493MM8/2555MM15x5/ 2555MM15x5
S	~86x21
M	26 PCS
	46%

13 315



C	001SCGR/001AB/001PARSH
E	P4/CE8x4/2494MM10,5
S	~25x25
M	78 PCS
	100%

13 316

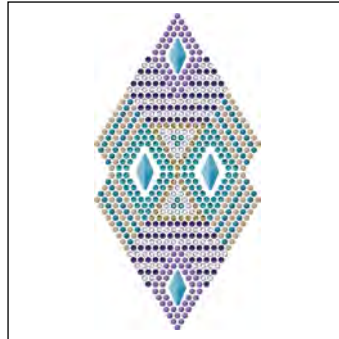

C	R1019/R4005/R5009/071- 265/263/277/001MLGLD/229
E	M2/M2/M2/M12x6-S6/S6/S6/S6/S6
S	~55x105
M	15 PCS
	40%

13 317

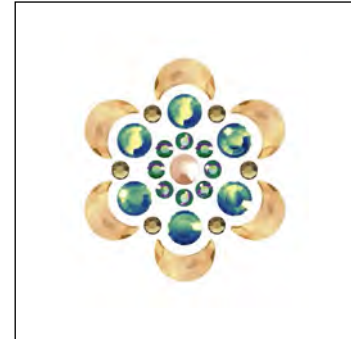

C	001GSHA/001GSHA/001SCGR/ 001GSHA/001IRIG
E	P4/2813MM8X5,5/S8/S8/S20
S	~26x29
M	60 PCS
	100%

13 318



C	R5009/R4005-001/001AB/280AB/ 001SCGR/001BLSH
E	M3X3/M12X6-2037MM8/2708MM8X8,7/ S6/S8/2304MM10X2,8
S	~38x33
M	50 PCS
	100%

13 319

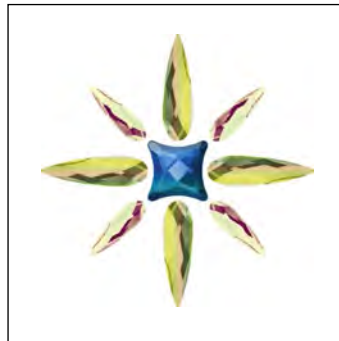

C	001BBL/001AB/001LUMG
E	2494MM8/2304MM10X2,8/ 2304MM14X3,9
S	~38x33
M	40 PCS
	100%

13 320

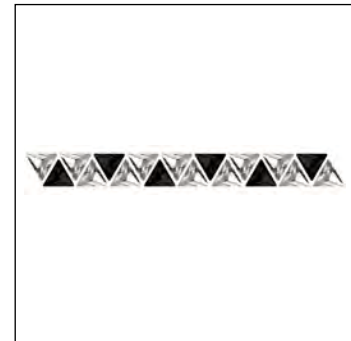

C	001/280
E	2720MM7,5/2720MM7,5
S	~76x8
M	45 PCS
	55%

TRANSFERS

CRYSTAL INSPIRATION COLLECTION

Extensive trend research allows Swarovski to present its own Crystal Inspiration Collections twice a year. These collections reflect the trends of coming fashion seasons (Spring/Summer and Fall/Winter) and include new and innovative design ideas, shapes, and colors in tune with these trends.



12 276 F/W 2007/08



C	208/501/227AB/236/227/501/208/227SAT
E	S6/S6/S6/S6/S8/S8/S10/S10
S	~80x177
M	12 PCS 25%

12 541 F/W 2009/10

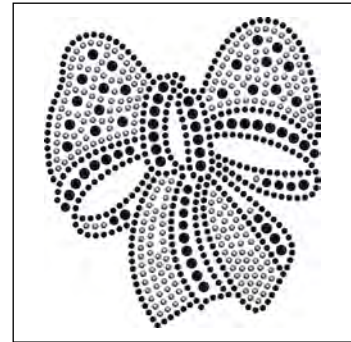

C	280/280HEM/288/288
E	S5/S6/S10/S12
S	~81x91
M	20 PCS 45%

12 771 S/S 2012



C	001GSHA/001BRSH/001COP/001MLGLD/280NUT/001GSHA/001DOR/220
E	CS8X5/S6/S6/S6/S6/S8/S8/S10
S	~50x196
M	16 PCS 22%

12 871 S/S 2013

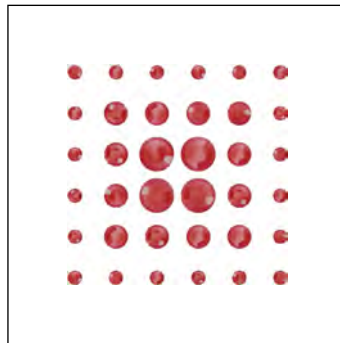

C	262/262/262
E	S6/S12/S20
S	~29x29
M	125 PCS 100%

12 906 F/W 2013/14

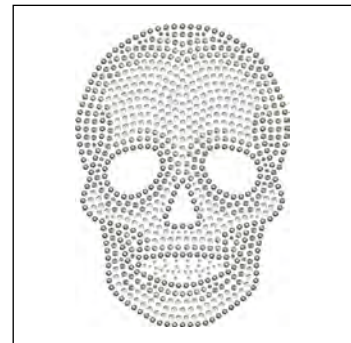

C	001/215/001/280HEM/001SSHA/215
E	S3/S3/S6/S6/S6/S6
S	~71x100
M	12 PCS 40%

12 928 F/W 2013/14

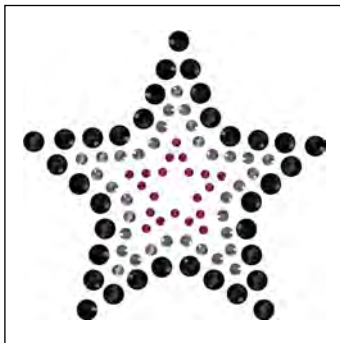

C	502/215/280
E	S6/S10/S20
S	~66x64
M	24 PCS 60%

13 020 S/S 2015

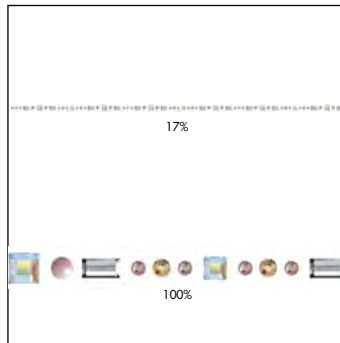

C	001294/001/001AB/001AB/319/362/234
E	P3/CS5x2/CS3x3/CS4x4/S6/S8/S8
S	~950x4 [11 SEG/ROW]
M	13 ROWS

13 032 S/S 2015

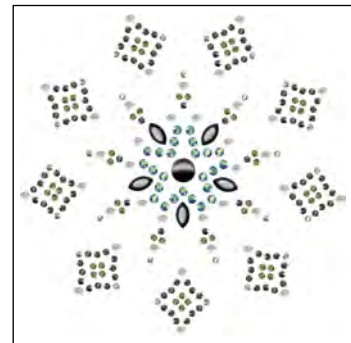

C	001LTCH/280HEM/280HEM/001SINI/001MLGLD/001SSHA/001IRIG
E	P3/P7/CS8x4/S6/S6/S6/S10
S	~95x94
M	18 PCS 45%

13 033 S/S 2015

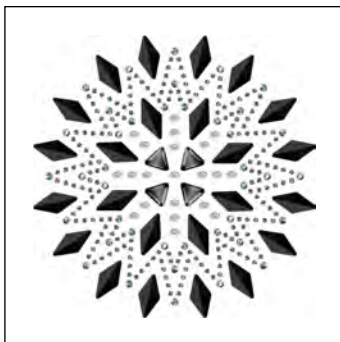

C	070-001LTCH/280HEM/215/001IRIG
E	M12x6-P3/CS7x6/S3/S6
S	~74x74
M	12 PCS 50%

13 034 S/S 2015

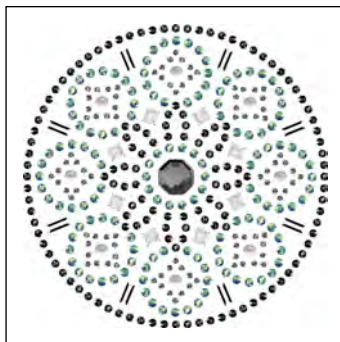

C	001LTCH/280HEM/001/001SINI/215/280HEM/001IRIG
E	P3/CS5x2/CS3x3/2611MM8/S3/S5/S6
S	~67x67
M	18 PCS 60%

13 036 S/S 2015

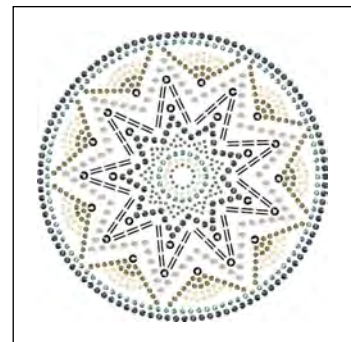

C	001LTCH/280HEM/215/001AB/001MLGLD/001IRIG/001SINI/001COS
E	P3/CS5x2/S3/S5/S6/S6/S8/S12
S	~110x110
M	4 PCS 35%



13 049

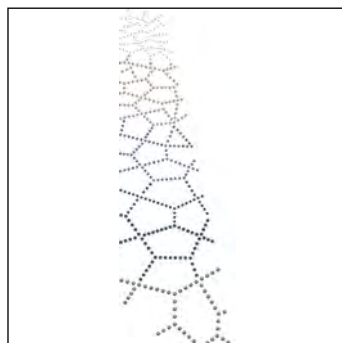

C 001/001SSHA/001BLSH/266/
207/280HEM
E S3/S6/S6/S6/S8/S10
S ~85x249
M 4 PCS 18%

13 050

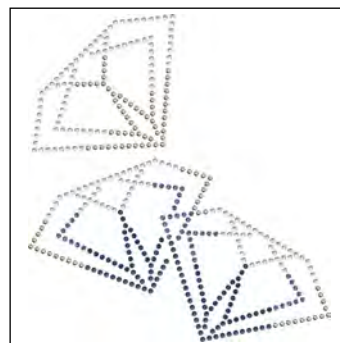

C 001/001SSHA/266/207/001BLSH
E S6/S6/S6/S6/S6
S ~114x124
M 14 PCS 35%

13 051

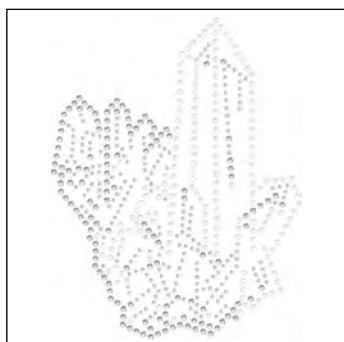

C 001AB/001/001MOL
E S3/S5/S6
S ~79x101
M 12 PCS 42%

13 052

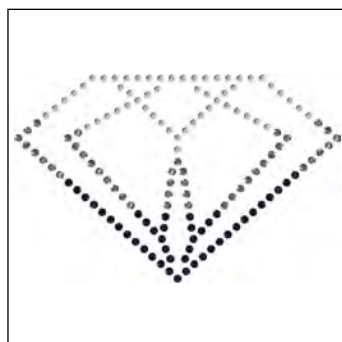

C 001/207/215
E S3/S3/S3
S ~57x36
M 50 PCS 76%

13 053

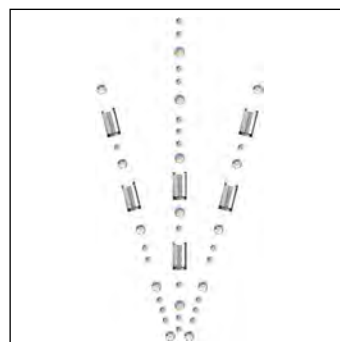

C 001/001/001/234
E CS5x2.5/S3/S5/S6
S ~30x58
M 48 PCS 73%

13 054



C 001/234/001MOL
E CS5x2.5/S6/S8
S ~41x67
M 60 PCS 65%

13 056

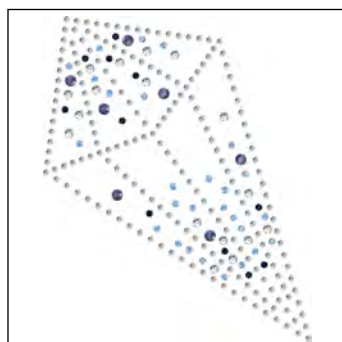

C 001/202/202/207/001/001BLSH
E S3/S3/S3/S3/S5/S5/S8
S ~55x66
M 24 PCS 65%

13 058

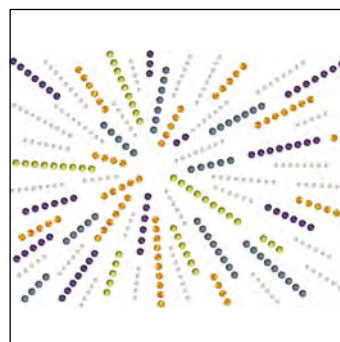

C 001AB/259/001VOL/001MBL/226
E S3/S6/S6/S6/S6
S ~91x69
M 15 PCS 50%

13 059

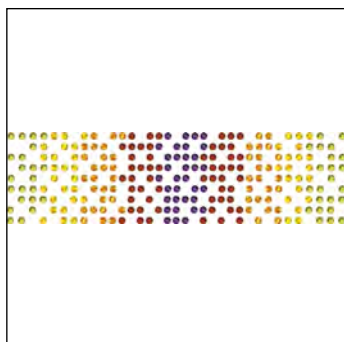

C 236/259/226/292/001VOL
E S6/S6/S6/S6/S6
S ~91x24
M 56 PCS 50%

13 060

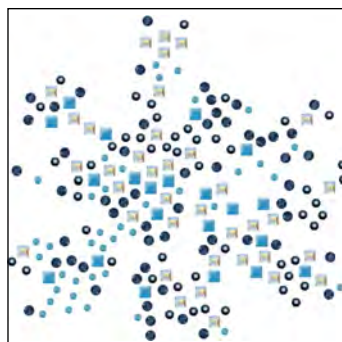

C 071/071-001AB/001METBL/266
E M2/M3x3-CS3x3/S8/S10
S ~90x86
M 20 PCS 50%

13 062

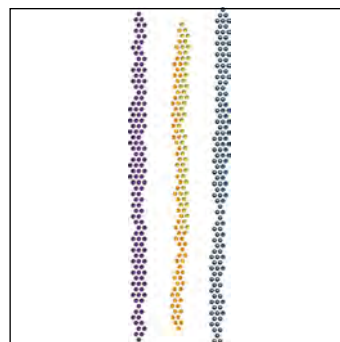

C 001METBL/001VOL/259/226/204/207
E S6/S6/S6/S6/S6/S6
S ~44x146
M 24 PCS 31%

13 067



C 070-280HEM/001/280/215/220/280/
215/280NUT
E M10x3-CS7x6/2797MM8x4/
2035MM6/S3/S3/S3/S3/S6
S ~75x117
M 12 PCS 36%

13 071

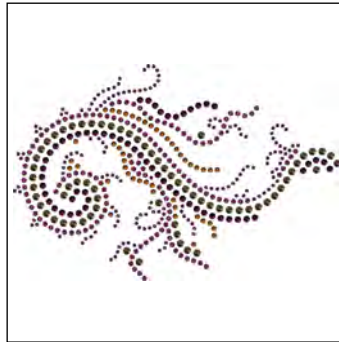

C 204/001LISH/220/515/280NUT
E S3/S6/S6/S8/S10
S ~120x79
M 12 PCS 36%

13 072

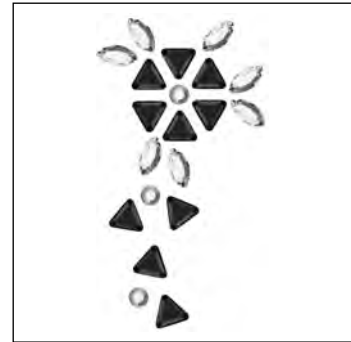

C 001SSHA/280HEM/265
E CS8x4/CS7x6/S16
S ~32x59
M 65 PCS 70%

13 073



C 280HEM/220/280NUT/220
E CS5x2.5/S6/S10/S16
S ~101x81
M 22 PCS 43%

13 074

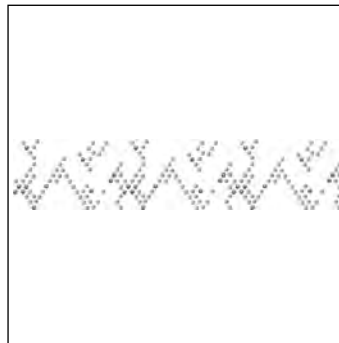

C 096-280HEM
E M2-S6
S ~964x31 (20 SEG/ROW)
M 5 ROWS 30%

13 075

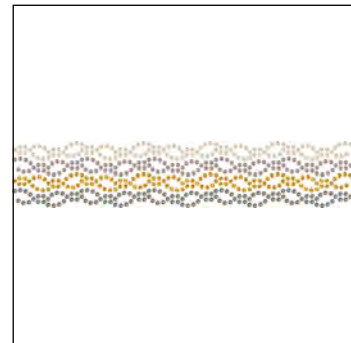

C 391/319/259/215
E S8/S8/S8/S8
S ~185x36
M 21 PCS 24%

13 076

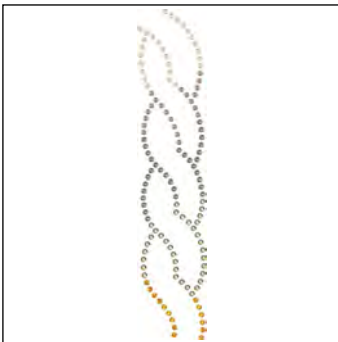

C 213SAT/215/391/319/259
E S6/S6/S6/S6/S6
S ~24x118
M 42 PCS 37%

13 077

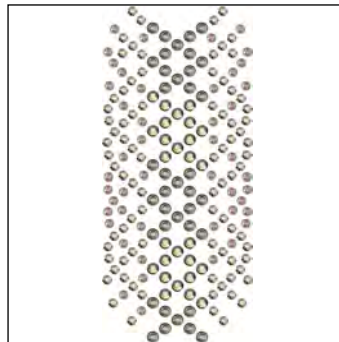

C 001SSHA/319/215/213SAT
E S6/S6/S8/S8
S ~30x67
M 60 PCS 66%

13 078

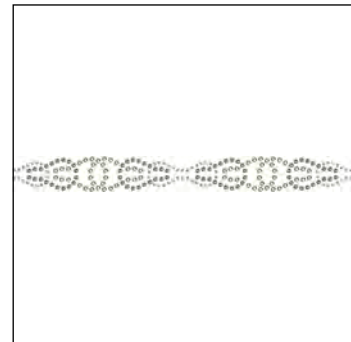

C 001SSHA/215/213SAT
E S3/S5/S6
S ~137x14
M 33 PCS 33%

13 079

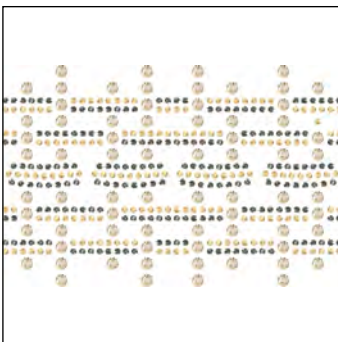

C 215/001GSHA/391
E S3/S3/S10
S ~75x49
M 18 PCS 60%

13 082

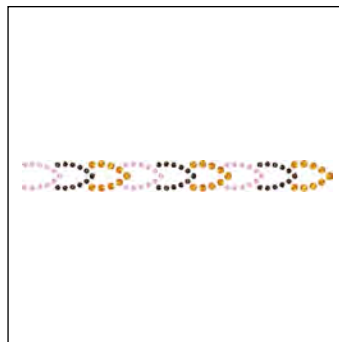

C 223/220/259
E S3/S3/S6
S ~482x8 (18 SEG/ROW)
M 12 ROWS 50%



13 087 **08**

C	092-001616/001SSHA/001AB
E	M3X3-P3/S3/S3
S	~20x20
M	162 PCS 100%

13 088 **08**

C	001AB/001SSHA/001/001/001SSHA
E	2817MM5/S3/S3/S5/S6
S	~57x59
M	36 PCS 70%

13 089 **08**

C	092-001/001SSHA/001SSHA/234/ 234/234/234
E	MST-2817MM5/S3/S6/S8/S10/S12/S16
S	~175x221
M	3 PCS 20%

13 090 **08**

C	082/082-215/001SSHA/001SINI/ 001SINI/383/001SINI
E	M2/M2.5-S6/S6/S6/S8/S8/S10
S	~162x244
M	4 PCS 17%

13 091 **08**

C	001SSHA/001/234/234
E	S3/S5/S6/S8
S	~34x34
M	90 PCS 100%

13 092 **08**

C	001SSHA/001/001/001MOL/234
E	S3/S3/2494MM6/S6/S6
S	~44x44
M	78 PCS 95%

13 095 **08**

C	001GSHA/001GSHA/213AB/261/261
E	S3/S6/S6/S8/S10
S	~65x124
M	12 PCS 33%

13 096 **08**

C	001616/001/001/234/234
E	P3/S3/S5/S6/S8
S	~32x32
M	78 PCS 100%

13 097 **08**

C	001616/001/001/001/234/001BLSH
E	P3/CS3X3/S3/S5/S6/S16
S	~45x45
M	65 PCS 95%

13 098 **08**

C	094-001/001GSHA/001MOL
E	M3X3-S3/S3/S6
S	~29x29
M	144 PCS 100%

13 099 **08**

C	001616/001/001SSHA/234
E	P3/CS3X3/S3/S6
S	~21x21
M	152 PCS 100%

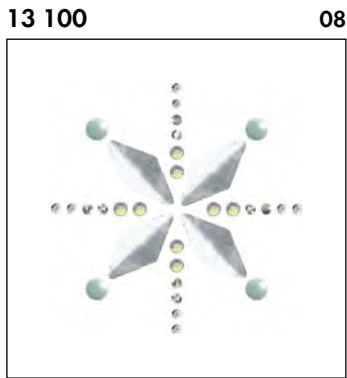

13 100 **08**
C 082-001616/001/001SSHA/234
E M12X6-P3/S3/S3/S6
S ~33x33
M 65 PCS **100%**

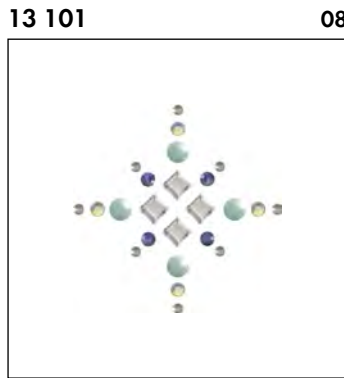

13 101 **08**
C 001616/001/001SSHA/001BLSH/234
E P3/CS3X3/S3/S6/S6
S ~27x27
M 152 PCS **100%**

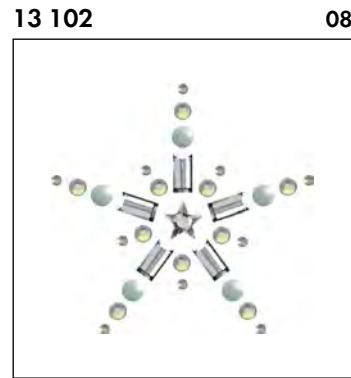

13 102 **08**
C 001616/001/001/001SSHA/234
E P3/CS5X2.5/2817MM5/S3/S8
S ~35x33
M 60 PCS **100%**

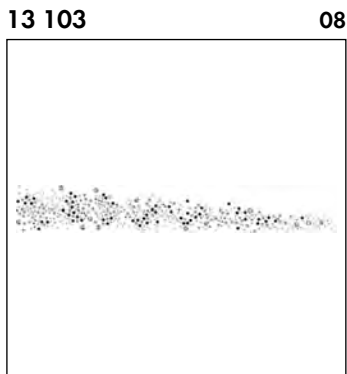

13 103 **08**
C 001LITCH/001MOL/001SSHA/001BLSH/001MOL/207/383/234/001SSHA
E P3/S6/S6/S6/S8/S10/S12/S12/S20
S ~283x42
M 12 PCS **15%**

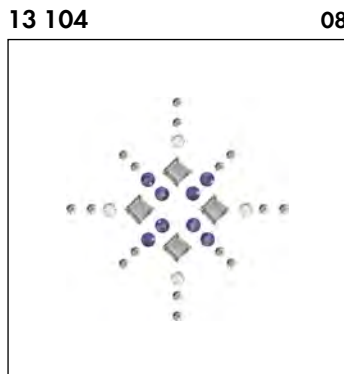

13 104 **08**
C 001/001/001BLSH/001MOL
E CS3X3/S3/S6/S6
S ~29x29
M 144 PCS **100%**

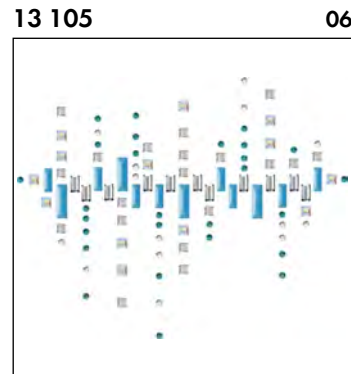

13 105 **06**
C 071/071-001/001/001AB/263/001
E M10x3/M7x3-CS5x2.5/CS3x3/CS3x3/S6/S6
S ~97x77
M 22 PCS **45%**

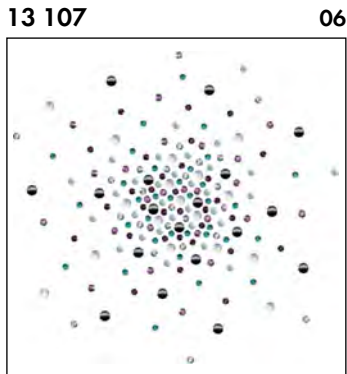

13 107 **06**
C 001616/280HEM/263/204/001ANTP/001PARSH/234
E P3/P4/S8/S8/S10/S10/S16
S ~123x118
M 7 PCS **35%**

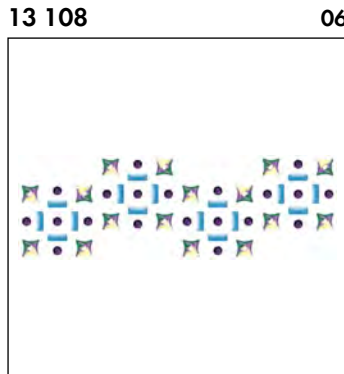

13 108 **06**
C 071-001PARSH/204
E M7x3-2494MM6/S12
S ~112x35
M 28 PCS **37%**

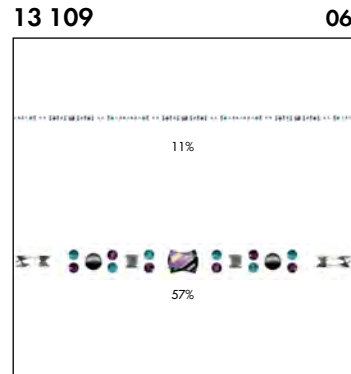

13 109 **06**
C 092-280HEM/001709/001/001PARSH/204/263/001PARSH
E M2x3P4/P4/2555MM8x2.6/2540MM7x5.5/S8/S8/S10
S ~94x6 (7 seg/row)
M 10 ROWS

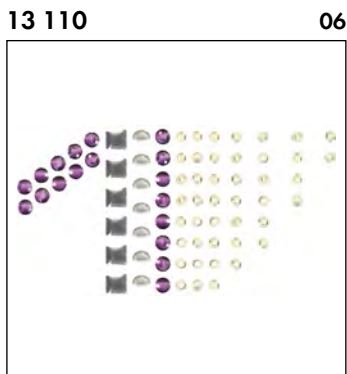

13 110 **06**
C 092-001LITCH/001AB/001ANTP
E M3x3-P3/S5/S8
S ~50x26
M 95 PCS **85%**

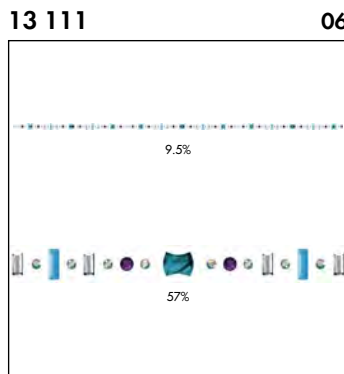

13 111 **06**
C 071-001/263/263/001PARSH/204
E M7x3-CS5x2.5/2540MM7x5.5/2494MM6/S8/S12
S ~920x7 (6 seg/row)
M 10 ROWS

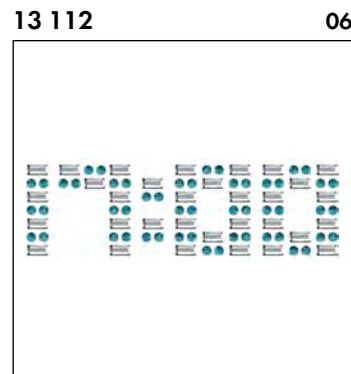

13 112 **06**
C 001/263
E CS5x2.5/S8
S ~75x22
M 66 PCS **55%**

13 113 06

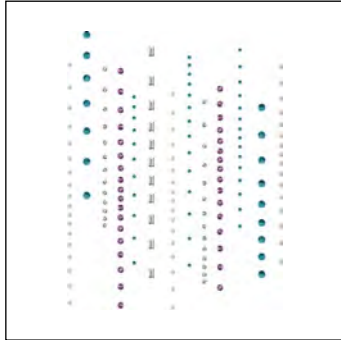

C 092-001/263/001PARSH/001ANTP/263
 E M2,5-CS5x2,5/S6/S8/S12/S16
 S ~114x147
 M 8 PCS 25%

13 114 06

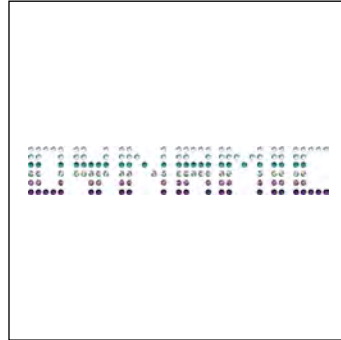

C 001/263/001PARSH/204/202/001ANTP
 E S6/S6/S6/S6/S6/S6
 S ~100x16
 M 76 PCS 40%

13 115 10



C 096-001TRAHFT/292/001LUMG
 E M7X3-S6/S8/S10
 S ~77x55
 M 39 PCS 55%

13 116 10

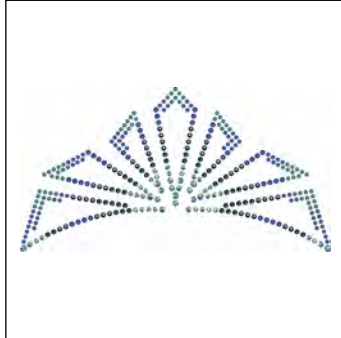

C 243/229/001METBL/229SAT/243/
 001IRIG/001IRIG/001IRIG
 E S6/S6/S8/S8/S8/S8/S10/S12
 S ~147x77
 M 12 PCS 28%

13 117 10

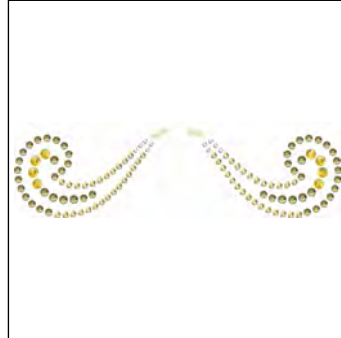

C 001AB/001AB/213AB/001GSHA/
 001GSHA/001METSH
 E 2788MM8/S6/S8/S10/S12/S16
 S ~123x34
 M 35 PCS 35%

13 119 10



C 001AB/001AB/001LUMG/001IRIG/
 001IRIG/001IRIG/001IRIG
 E S3/S5/S6/S6/S8/S10/S16
 S ~110x97
 M 8 PCS 38%

13 120 10



C 001PBLUHFT/229/001IRIG/001IRIG/
 001METBL/243
 E P3/S8/S8/S10/S12/S16
 S ~169x53
 M 15 PCS 25%

13 122 10

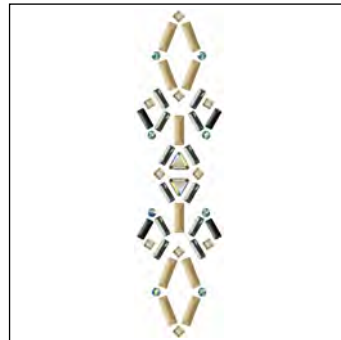

C 094/096/070-001GSHA/001AB/001IRIG
 E M10X3/M7X3/M7X3-CS3X3/CS7X6/S10
 S ~28x108
 M 48 PCS 40%

13 123 10

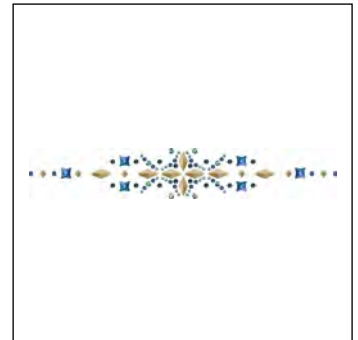

C 094/094-001BBL/001IRIG/243/
 229SAT/001IRIG
 E M3X3/M12X6-2494MM6/S6/S8/S10/S12
 S ~184x30
 M 25 PCS 22%

13 127 04

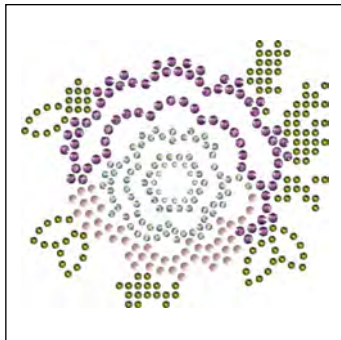

C 001294/265/228/001PARSH/001ANTP
 E P3/S6/S8/S8/S12
 S ~101x88
 M 20 PCS 40%

13 129 04



C 090-391
 E M3X3-S8
 S ~90x90
 M 26 PCS 45%

13 131 04

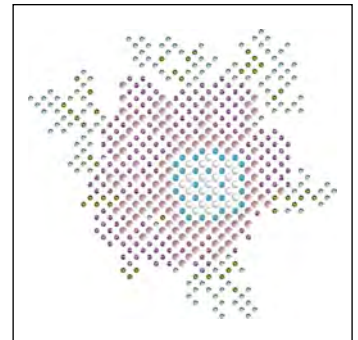

C 071-001294/001650/001ANTP/360/
 228
 E M2,5-P3/P3/S6/S6/S6
 S ~116x109
 M 14 PCS 35%

13 132 04



C 228/205/291/214
 E S6/S6/S6/S8
 S ~70x72
 M 24 PCS 60%

13 133 04

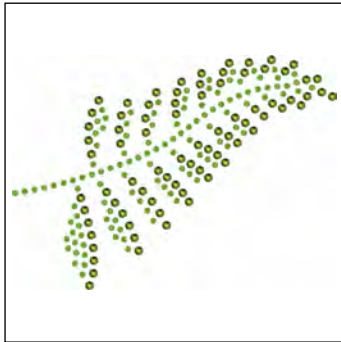

C 214/228
 E S3/S6
 S ~72x52
 M 36 PCS 60%

13 134 04

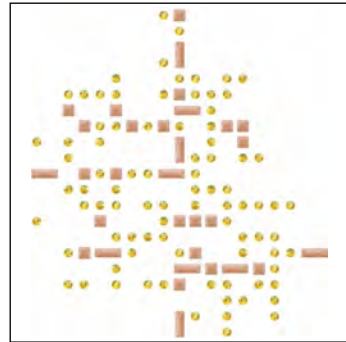

C 080/080-001METSH
 E M3X3/M7X3-S8
 S ~78x87
 M 24 PCS 50%

13 135 04

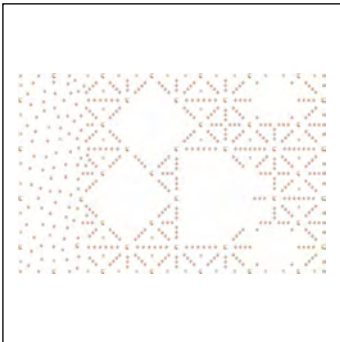

C 080-001205/391
 E M2-P3/S6
 S ~184x120
 M 7 PCS 22%

13 136 04

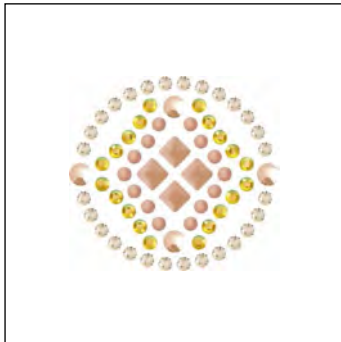

C 090/080-001205/391/001METSH
 E M2/M3X3-P3/S6/S6
 S ~28x26
 M 162 PCS 100%

13 137 04

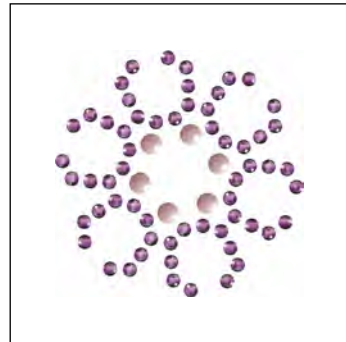

C 001294/001ANTP
 E P3/S6
 S ~33x32
 M 120 PCS 100%

13 140 04

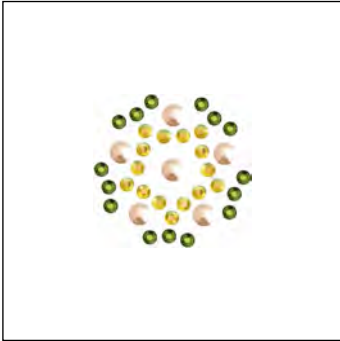

C 001205/001METSH/228
 E P3/S6/S6
 S ~21x20
 M 224 PCS 100%



13 149 08

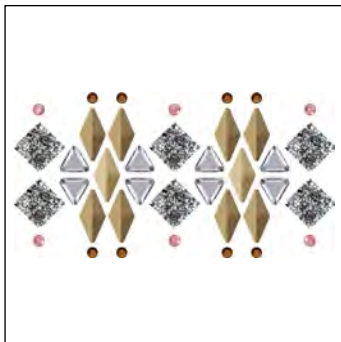

C 084/094-001/001BLAPA/220/257
 E M12X6/M12X6-CS7X6/
 2493MM8/S8/S10
 S ~71x36
 M 44 PCS 60%

13 150 08



C 084/084-001LTCH/280HEM/257/215
 E M8/M12X6-P3/CS7X6/
 2813MM8X5,5/S10
 S ~79x60
 M 33 PCS 50%

13 151 08

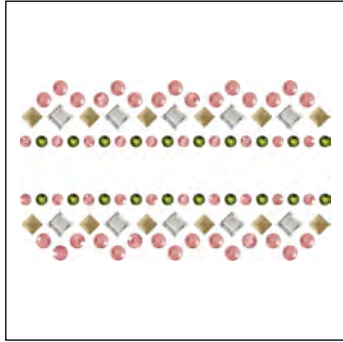

C 094-001/257/228/257
 E M3X3-CS4X4/S8/S8/S12
 S ~63x37
 M 60 PCS 65%

13 152 08

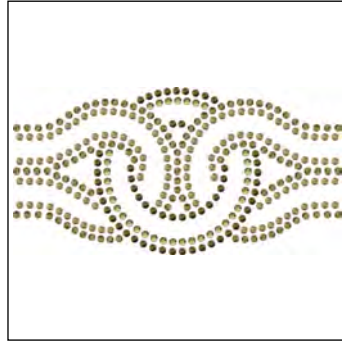

C 084-001MLGLD/001DOR/001GSHA
 E M2-S6/S6/S6
 S ~87x44
 M 40 PCS 50%

13 153 08

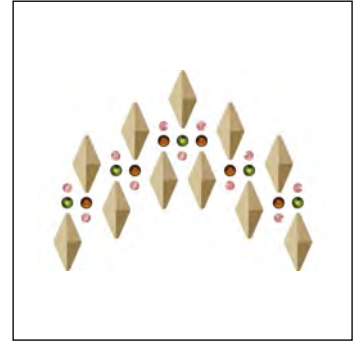

C 094-257/220/228
 E M12X6-S6/S8/S8
 S ~52x41
 M 64 PCS 65%

13 154 08



C 094-001GSHA
 E M10X3-2555MM8X2,6
 S ~51x23
 M 75 PCS 75%

13 155 08

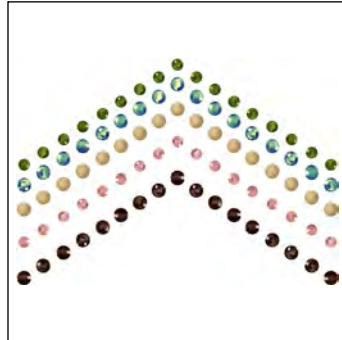

C 094-228/257/001IRIG/220
 E M2,5-S6/S6/S8/S8
 S ~53x37
 M 60 PCS 80%

13 159 08



C 001HFT/284/001IRIG
 E S6/S6/S6
 S ~76x105
 M 24 PCS 40%

13 161 10

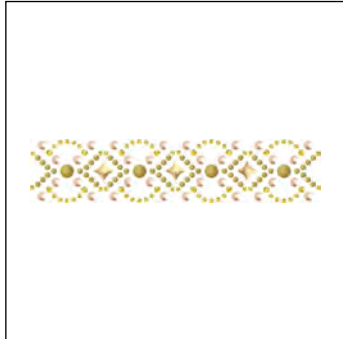

C 091/091-001GSHA/001GSHA/
 001METSH/001METSH
 E M2,5/M6-P4/2494MM6/S6/S10
 S ~128x28
 M 35 PCS 30%

13 162 10



C 091-001GSHA/001GSHA/
 001METSH/001MOL
 E M2,5-P4/2494MM6/S6/S34
 S ~40x28
 M 96 PCS 100%

13 164 10

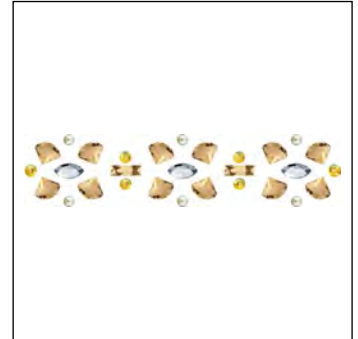

C 001291/001/001GSHA/001GSHA/
 001METSH
 E P3/CS8X4/2555MM8X2,6/2714MM60/S12
 S ~84x19
 M 30 PCS 50%

13 167



C 280HEM/001LTCH/001/001/001SINI/
 227/001
 E P4/P7/2770MM60X35/2770MM120X70/
 2714MM60/2714MM140/2813MM14X9,5
 S ~37x40
 M 36 PCS 100%

13 168

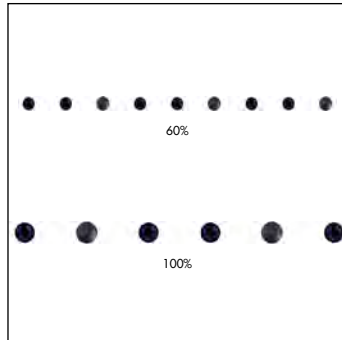

C 280HEM/288
 E P3/S10
 S ~978x3 (39 SEG/ROW)
 M 13 ROWS

13 170 10

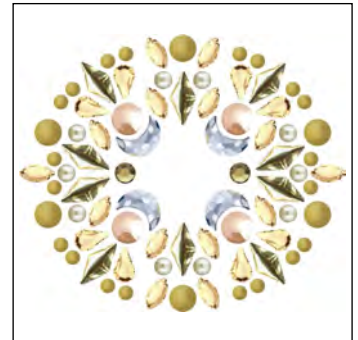

C 091/091/091-001291/001GSHA/
 001GSHA/001GSHA/001/001GSHA
 E M3/M6/M12X6-P4/P7/CS8X5/
 CS8X4/2813MM10X7/S20
 S ~72x61
 M 18 PCS 60%

13 171 10

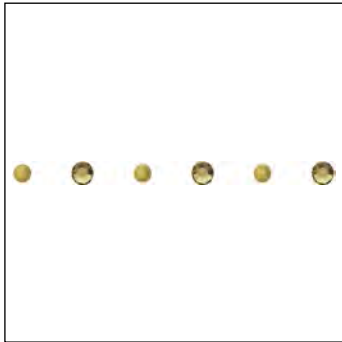

C 091-001GSHA
E M2,5-S12
S ~969x3 [58 SEG/ROW]
M 14 ROWS 95%

13 173 10



C 081/091-001291/001METSH
E M2,5/M8-P3/S6
S ~22x32
M 198 PCS 100%

13 174 10

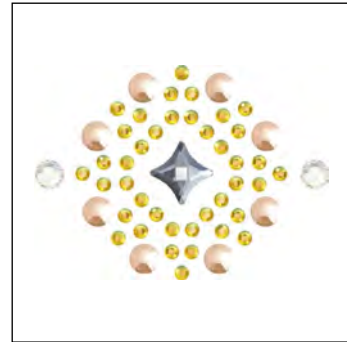

C 001GSHA/001/001METSH/001MOL
E P4/2494MM6/S6/S16
S ~39x28
M 120 PCS 100%

13 175 10



C 091-001GSHA/001GSHA/001MOL/
234/001MOL
E M12X6-P3/CS8X4/2813MM8X5,5/
2753MM10/S10
S ~32x34
M 110 PCS 100%

13 176 09



C 086/096/084/094/096/084-001/
001BLAPA/228
E M7X7/M7X7/M7X7/M7X7/M3X3/
M3X3-CS3X3/2493MM12/S8
S ~245x206
M 3 PCS 16%

13 177 06

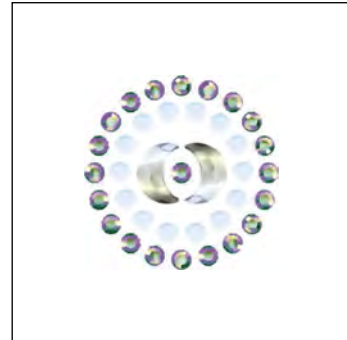

C 001PBLUHFT/001MOL/001SCGR
E P3/2813MM8X5,5/S10
S ~26x26
M 78 PCS 100%

13 178 06

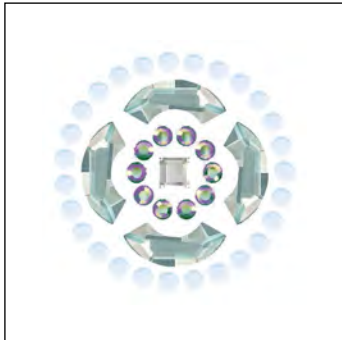

C 001PBLUHFT/001/001/001SCGR
E P3/CS4X4/2037MM14/S10
S ~32x32
M 50 PCS 100%

13 179 06

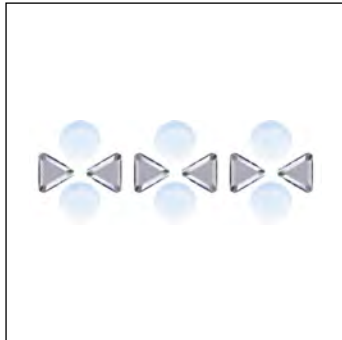

C 001PBLUHFT/001
E P7/CS7X6
S ~46x17
M 48 PCS 80%

13 180 06

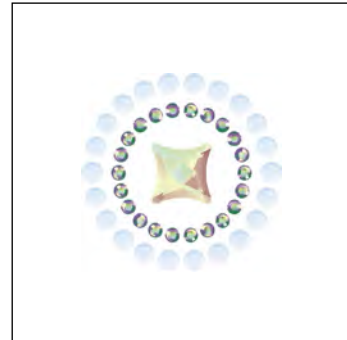

C 001PBLUHFT/001AB/001SCGR
E P3/2494MM8/S6
S ~26x26
M 60 PCS 100%

13 181 06

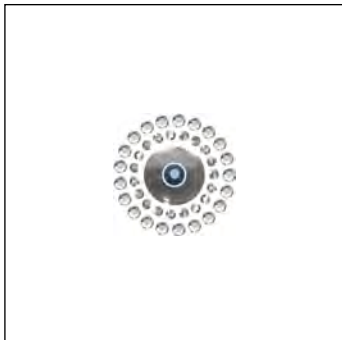

C 092-001SSHA/001/001METBL
E M8-S3/S5/S10
S ~16x16
M 144 PCS 100%

13 182 06

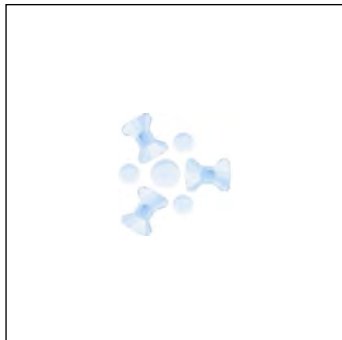

C 001PBLUHFT/001PBLUHFT/001PBLUHFT
E P3/P4/2858MM6X4,5
S ~15x16
M 105 PCS 100%

13 183 06

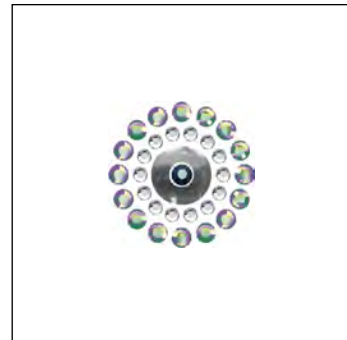

C 092-001/001SCGR/001METBL
E M8-S6/S10/S10
S ~19x19
M 112 PCS 100%

13 184 06

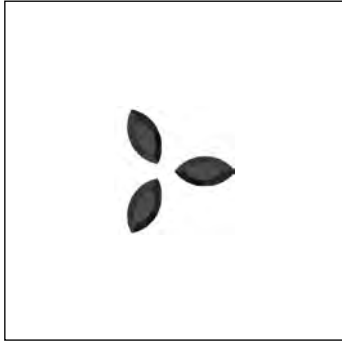

C 280HEM
E CS8X4
S ~14x16
M 264 PCS 100%

13 186 06

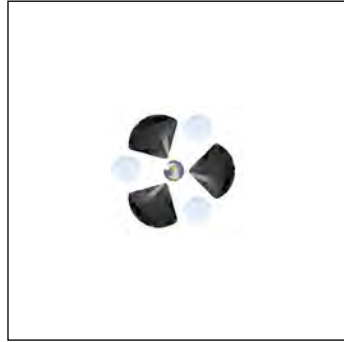

C 001PBLUHFT/001SINI/001SCGR
E P4/2714MM60/S10
S ~16x15
M 119 PCS 100%

13 187 06



C 001PBLUHFT/001PBLUHFT/001/001SCGR
E P3/P4/2813MM8X5,5/S16
S ~19x17
M 112 PCS 100%

13 188 06



C 001PBLUHFT/001/001SCGR
E P3/2494MM6/S10
S ~19x18
M 112 PCS 100%

13 189 06

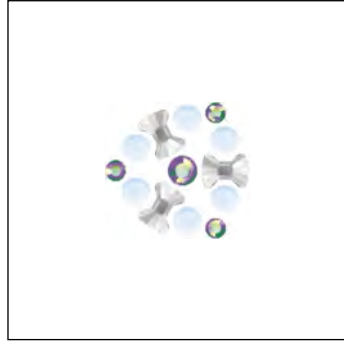

C 001PBLUHFT/001/001SCGR/001SCGR
E P4/2858MM6X4,5/S10/S16
S ~19x18
M 105 PCS 100%

13 190 06

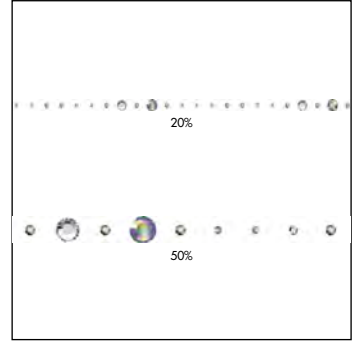

C 001SCGR/001LITCH/001SSHA/001/001SCGR
E S6/S8/S10/S30/S34
S ~952x7 (8 SEG/ROW)
M 8 ROWS

13 191 06



C 092/082-001GSHA
E M3X3/M3X3-CS3X3
S ~76x20
M 77 PCS 50%

13 192 06

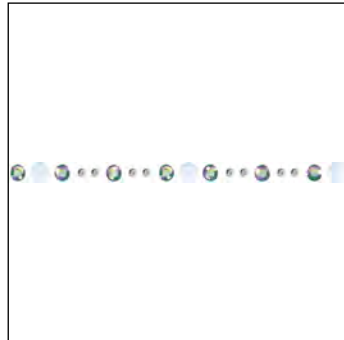

C 001PBLUHFT/001/001SCGR
E P3/S3/S8
S ~492x3 (22 SEG/ROW)
M 13 ROWS 90%

13 193 06

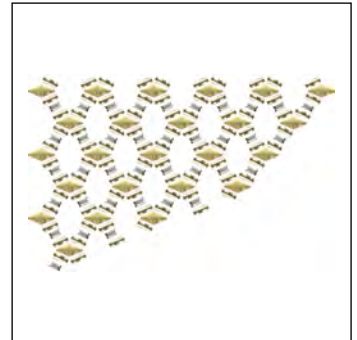

C 091/081-001AB
E M7X3/M12X6-CS5X2,5
S ~135x85
M 12 PCS 30%

13 194 06

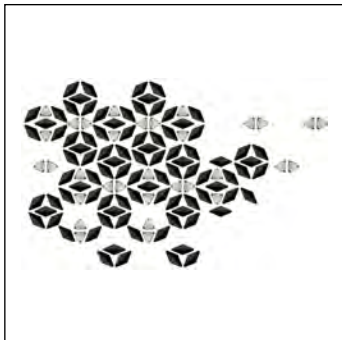

C 070/070-001AB
E M12X6/M12X6-CS7X6
S ~161x98
M 10 PCS 25%

13 195 06

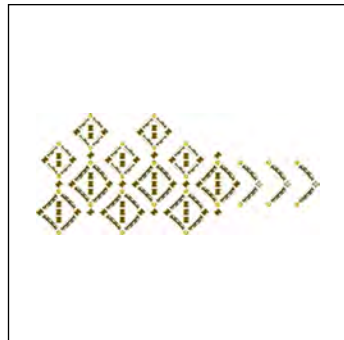

C 091/091/091-001GSHA/001METSH/
001METSH
E M3X3/M10X3/M7X3-CS3X3/S8/S10
S ~150x64
M 18 PCS 25%

13 196 06

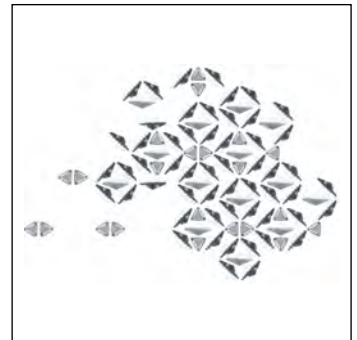

C 092/082-001
E M12X6/M12X6-CS7X6
S ~137x94
M 14 PCS 30%

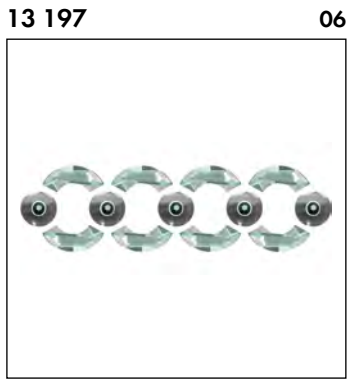

13 197 **06**
 C 092/001/001METBL
 E M8-2037MM14/S10
 S ~68x19
 M 36 PCS **60%**

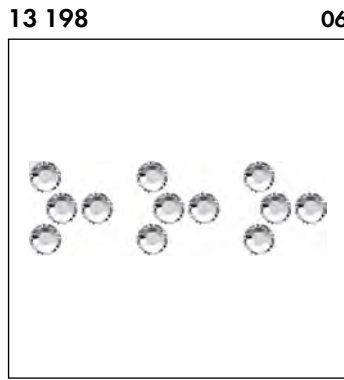

13 198 **06**
 C 001
 E S20G
 S ~44x14
 M 56 PCS **90%**

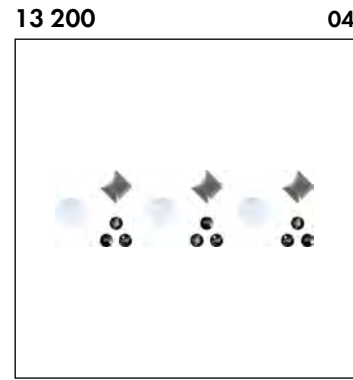

13 200 **04**
 C 082/001PBLUHFT/280HEM
 E M3X3-P4/S5
 S ~98x10 (82 SEG/ROW)
 M 11 ROWS **100%**

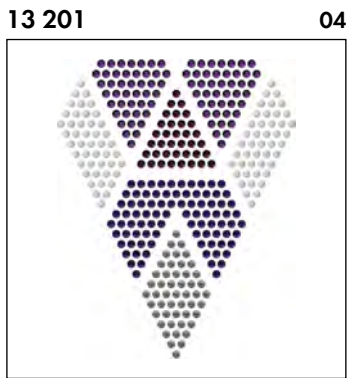

13 201 **04**
 C 092/086-277/204/515
 E M2/M2-S6/S6/S6
 S ~57x72
 M 39 PCS **55%**

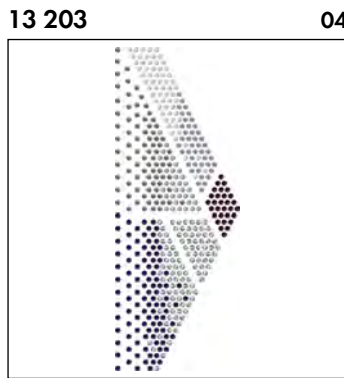

13 203 **04**
 C 086/092/082/096-001SCGR/277/515
 E M2/M2/M2/M2-S6/S6/S6
 S ~47x122
 M 28 PCS **35%**

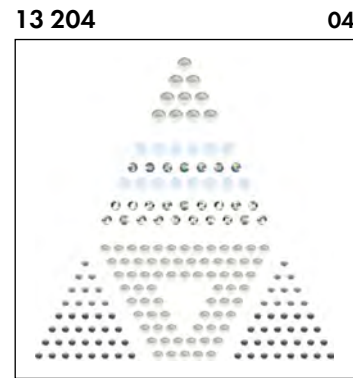

13 204 **04**
 C 092/082-001LTCH/001PBLUHFT/
 001LTCH/001LTCH/001SCGR
 E M2/M2-P3/P4/P4/S10/S10
 S ~82x83
 M 22 PCS **48%**

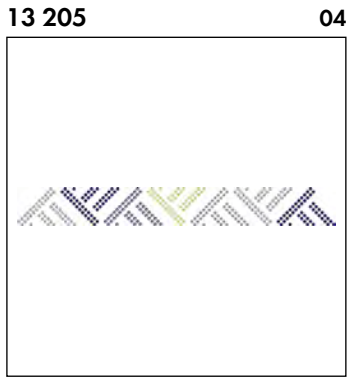

13 205 **04**
 C 082-277/001SCGR/280AB/001LUMG
 E M2-S6/S6/S6/S6
 S ~191x23
 M 29 PCS **22%**

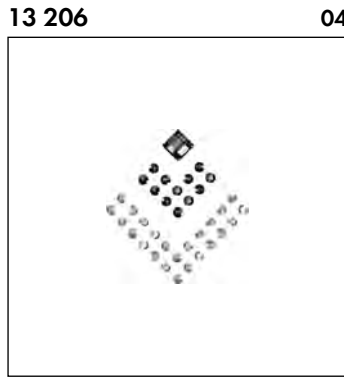

13 206 **04**
 C 280HEM/001SSHA/280HEM
 E CS3X3/S3/S3
 S ~19x20
 M 220 PCS **100%**

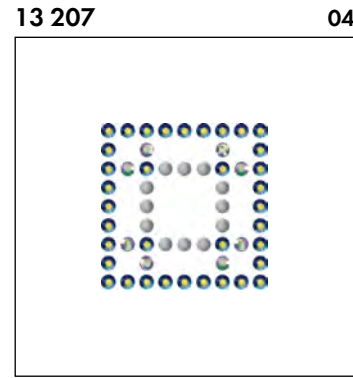

13 207 **04**
 C 096-280AB/001SCGR
 E M2-S6/S6
 S ~22x22
 M 210 PCS **100%**

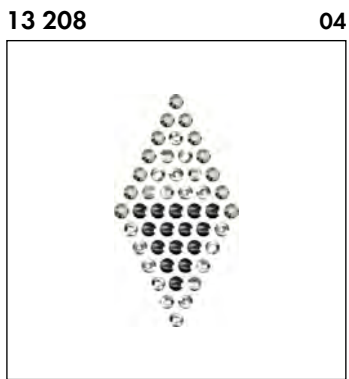

13 208 **04**
 C 070-001LTCH/001SSHA
 E M2-S6/S6
 S ~16x31
 M 234 PCS **100%**

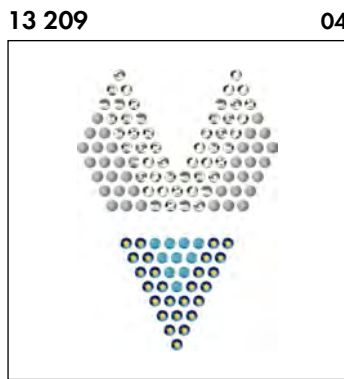

13 209 **04**
 C 096/071-001LTCH/280AB
 E M2/M2-S6/S6
 S ~33x47
 M 96 PCS **80%**

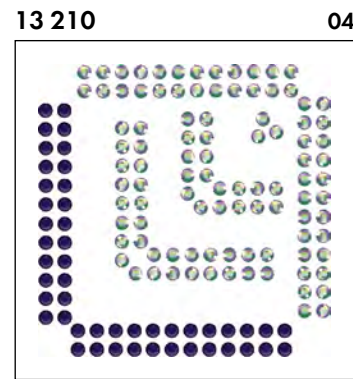

13 210 **04**
 C 001SCGR/277
 E S6/S6
 S ~39x39
 M 80 PCS **100%**



13 213 04

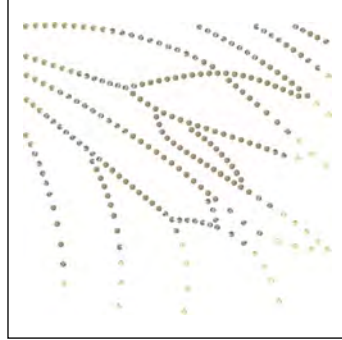

C R1019/284/261/383
E M2/S6/S6/S6
S ~102x97
M 18 PCS 40%

13 214 04

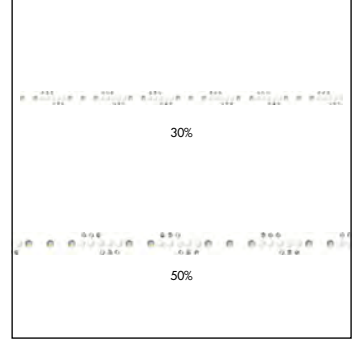

C R9003/001SSHA/234
E M2/S3/S6
S ~474x6 (10 SEG/ROW)
M 14 ROWS

13 215 04



C R9003/001PBLUHFT/001TRAHFT/
001HFT/001/234/234
E M2/P4/S6/S8/S8/S10/S12
S ~154x59
M 18 PCS 26%

13 216 04

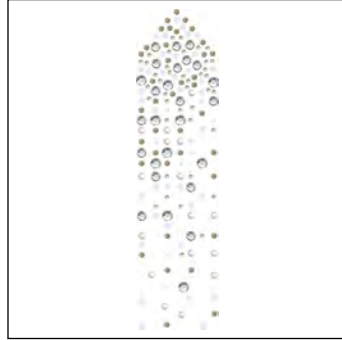

C 001 SR/R9003/R1019/001PBLUHFT/
001650/234/001
E FFB16/M2/M2,5/P3/P3/S6/S20G
S ~36x141
M 24 PCS 30%

13 217 04

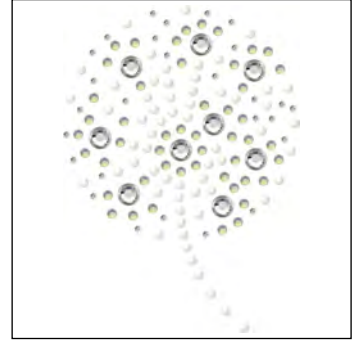

C 001 SR/R9003/001/234
E FFB16/M2/S3/S6
S ~46x64
M 32 PCS 100%

13 218 04

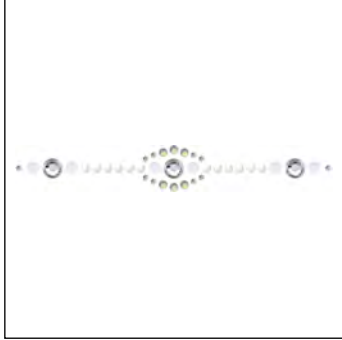

C 001 SR/R9003/001PBLUHFT/001/234
E FFB16/M2/P3/S3/S6
S ~70x10
M 90 PCS 60%

13 219 04

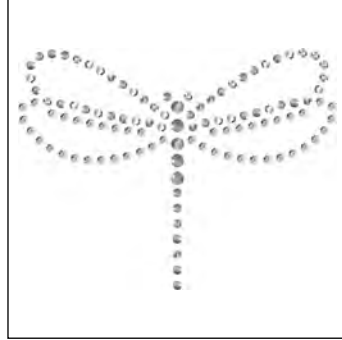

C 001SSHA/001/284
E S3/S3/S6
S ~47x36
M 40 PCS 90%

13 220 06



C R1019/280/253/246
E M2/CS7x6/S12/S34
S ~38x38
M 84 PCS 100%

13 221 06

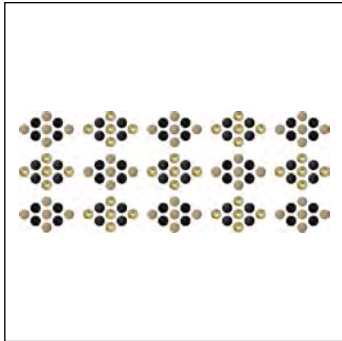

C R1019/R9005/246/280
E M2/M2/S6/S6
S ~58x23
M 90 PCS 70%

13 222 06

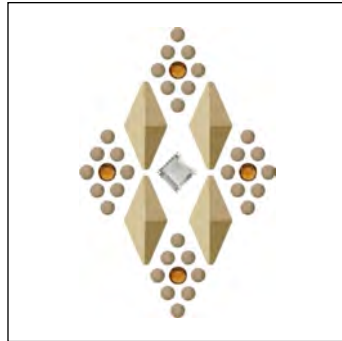

C R1019/094/001/203
E M2/M12x6/CS4x4/S8
S ~26x38
M 120 PCS 100%

13 223 06

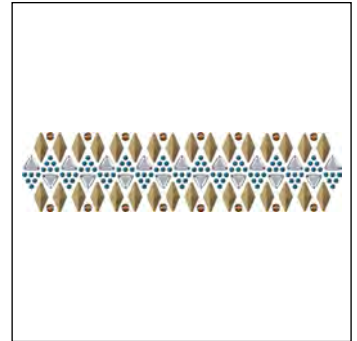

C R5009/084/001/001COP
E M2/M12x6/CS7x6/S12
S ~128x32
M 30 PCS 33%

TRANSFERS

CRYSTAL INSPIRATION COLLECTION

13 224 06

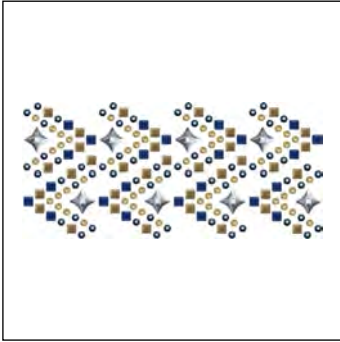

C 084/R5009/001/001METBL/246
 E M3x3/M3x3/2494MM6/S8/S8
 S ~98x45
 M 36 PCS 40%

13 225 09

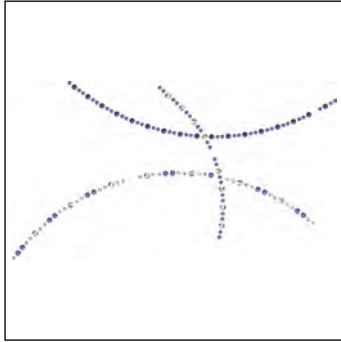

C 206/001LTCH/207/206/001LTCH
 E S6/S6/S10/S10/S12
 S ~171x94
 M 10 PCS 25%

13 226 11

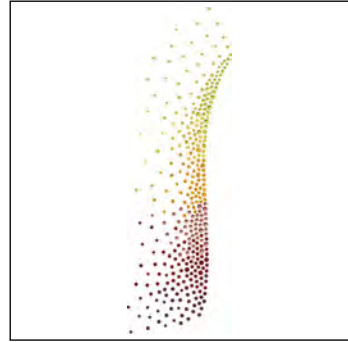

C 249/227SAT/259/227/001METSH/542/227/259/542/001METSH/27SAT/249/542/249/259/227/001METSH
 E S6/S6/S6/S6/S6/S6/S8/S8/S8/S8/S8/S12/S12/S12/S12/S12
 S ~69x215
 M 6 PCS 20%

13 227 10

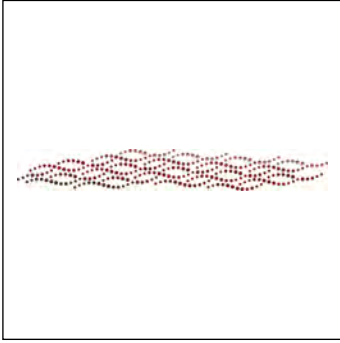

C 327/236/227/208/542/227SAT/327/227/208/236/542/227SAT/208/327/227/542/236/227SAT
 E S6/S6/S6/S6/S6/S6/S8/S8/S8/S8/S8/S8/S10/S10/S10/S10/S10/S10
 S ~228x30
 M 10 PCS 18%

13 228 10

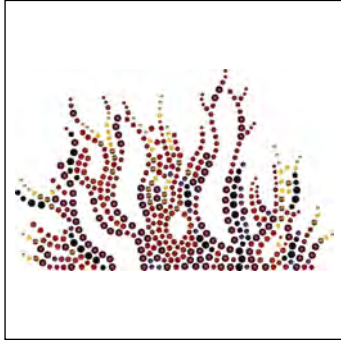

C 280/280/001GSA/208/236/208/227/001METSH/204/327/236/001COP/227SAT
 E P3/P4/S6/S6/S6/S10/S10/S10/S10/S12/S12/S12/S16
 S ~168x106
 M 4 PCS 25%

13 229 10

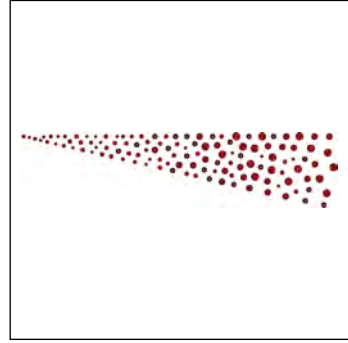

C 208/227/327/227SAT/227/327
 E S6/S8/S10/S12/S16/S20
 S ~181x43
 M 20 PCS 23%

13 230 10

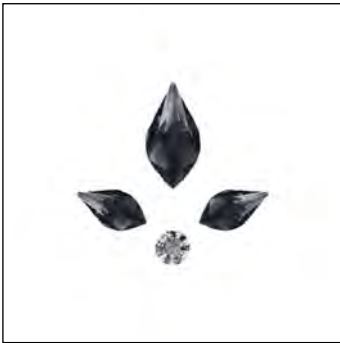

C 001SINI/001SINI/001BLAPA
 E 2205MM10/2205MM14/2034SS20
 S ~25x24
 M 174 PCS 100%

13 231 10

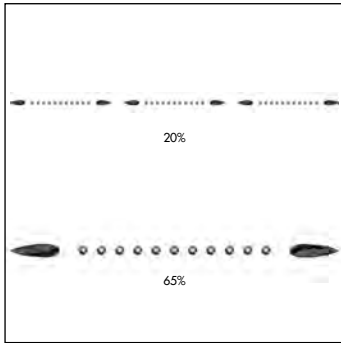

C 280HEM/001SINI
 E S6/2304MM10x2,8
 S ~967x3 (13 SEG/ROW)
 M 11 ROWS

13 232 08

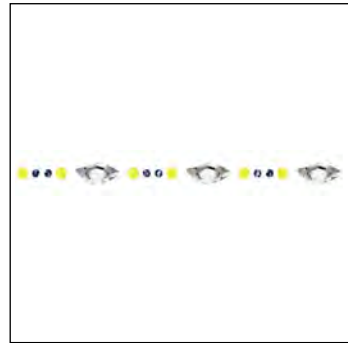

C 001/001METBL/231
 E 2797MM8x4/S3/S6
 S ~494x4 (25 SEG/ROW)
 M 12 ROWS 75%

13 233 08

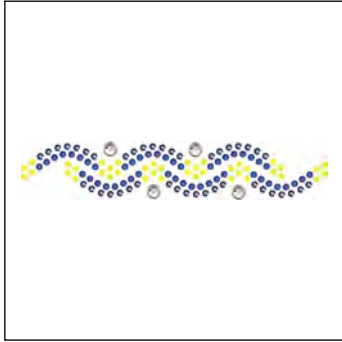

C	001 SR/243/206SAT/231
E	FFB16/S6/S6/S6
S	~90x17
M	63 PCS 45%

13 234 08



C	001AB/266/213AB/263
E	CE8x4/S6/S6/S6
S	~41x35
M	95 PCS 100%

13 235 08



C	001650/001650/001/001METBL/229/001BLSH/206SAT/001AB
E	P3/P4/2788MM8/S3/S5/S6/S8/2612MM6
S	~119x104
M	8 PCS 35%

13 236 08

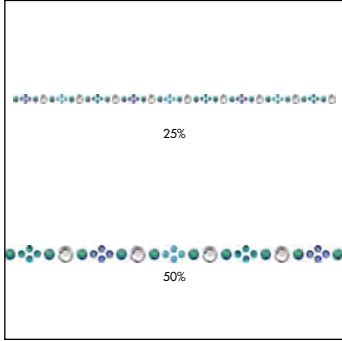

C	001 SR/071/001SCGR/206/263
E	FFB16/M2/P3/S6/S6
S	~967x4 (17 SEG/ROW)
M	11 ROWS

13 237 08

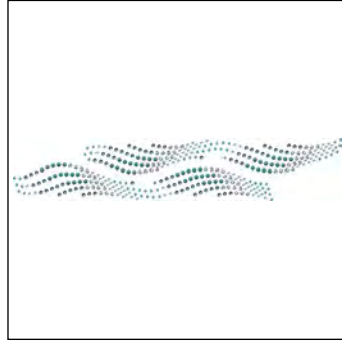

C	071/001SCGR/202/280AB/001SCGR
E	M2/P3/S6/S8/S10
S	~217x41
M	19 PCS 20%

13 238 03

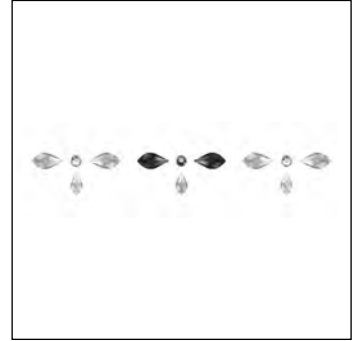

C	001/280HEM/001AB/001/001/001SINI
E	FFB20/FFB20/2205MM10/2205MM10/2205MM14/2205MM14
S	~131x18
M	36 PCS 30%

13 239 03



C	237/237/237
E	2205MM7,5/2205MM10/2205MM14
S	~57x69
M	33 PCS 50%

13 240 03



C	001AB/280/253/001IRIG/001/001GSHA/001/001AB
E	2798MM8/2798MM8/2798MM10/2798MM10/2798MM14/2205MM7,5/2205MM10/2205MM14
S	~53x41
M	51 PCS 60%



13 242 **03**

C 001PGRHFT/001PGRHFT/001/234	
E P3/P4/S3/S6	
S ~134x113	
M 6 PCS	32%

13 243 **03**

C R9003/R9003/R1019-001/234	
E M2/M2,5/M2,5-S3/S6	
S ~107x91	
M 10 PCS	38%

13 244 **03**

C R1019-001GSHA	
E M2-S3	
S ~25x25	
M 105 PCS	100%

13 245 **03**

C R1019/R1019/R1019-001GSHA/550/001GSHA/550	
E M2/M7x7/M3x3-CS3x3/S6/S6/S10	
S ~57x92	
M 33 PCS	46%

13 246 **04**

C 001HFT/001HFT	
E S8/S10	
S ~196x49	
M 16 PCS	20%

13 247 **07**

C 082/092-001PBLUHFT/001LTCH/001/001	
E M7x3/M7x3-P4/P4/CS6x4/CS7x6	
S ~266x196	
M 3 PCS	15%

13 251 **07**

C 001621/279/234/001/213AB/001PYELHFT/213	
E P4/S6/S6/2304MM10x2,8/S8/S10/S10	
S ~25x40	
M 114 PCS	100%

13 252 **07**

C R9003/R9003-001PBLUHFT/001650/001/001/213/001SSHA/001PYELHFT/001	
E M8/M7x3-P3/P4/2720MM7,5/2037MM8/S8/S10/S10/S12	
S ~45x43	
M 32 PCS	90%

13 253 07



C 001/001/001
 E 2739MM5,8x5,3/2739MM7x6,5/
 2740MM8,3x8,3
 S ~46x47
 M 51 PCS 90%

13 254 03

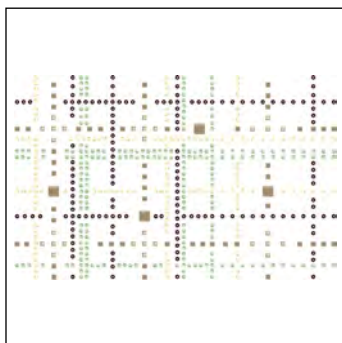

C R1019/R1019-001GSHA/001PGREHFT/
 001L108S/001L106S
 E M7x7/M3x3-CS3x3/S10/S10/S10
 S ~212x134
 M 6 PCS 20%

13 255 08

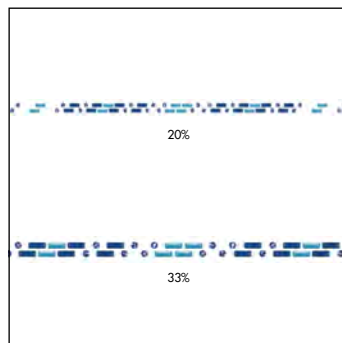

C R5009/071-L110S
 E M7x3/M7x3-S10
 S ~234x6
 M 52 PCS

13 256 08

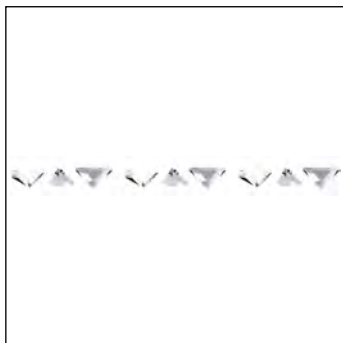

C 001/001/001
 E 2738MM10x5/2739MM5,8x5,3/
 2740MM8,3x8,3
 S ~973x6 (28 SEG/ROW)
 M 12 ROWS 43%

13 257 09

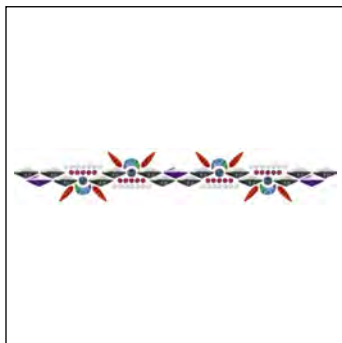

C 266 GM/092/096/R4005-001SCGR/
 501/227
 E FFB16/M2,5/M12x6/M12x6-
 2813MM8x5,5/S8/2304MM10x2,8
 S ~158x24
 M 12 PCS 27%

13 258 09

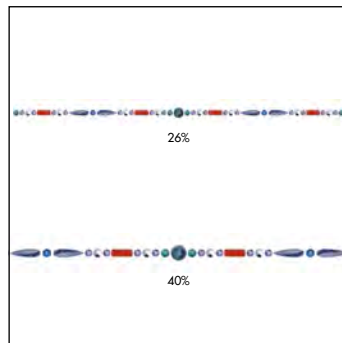

C 086266/R3020-001CHRMV/001SCGR/
 539/001BLSH/243
 E FFB20/M7x3-P3/P3/S8/
 2304MM10x2,8/S10
 S ~168x5
 M 23 PCS

13 259 09



C 266 SR/096-280HEM/001/227
 E FFB16/M7x3-P3/
 2037MM8/2304MM10x2,8
 S ~14x22
 M 117 PCS 100%

13 260 09



C 266 SR/092/092-253/001SCGR/
 243/227/001SINI/539/227
 E FFB16/M7x3/M12x6-CS3x3/
 2813MM8x5,5/S8/2304MM10x2,8/
 2304MM14x3,9/S10/S12
 S ~56x55
 M 21 PCS 78%

13 261 10

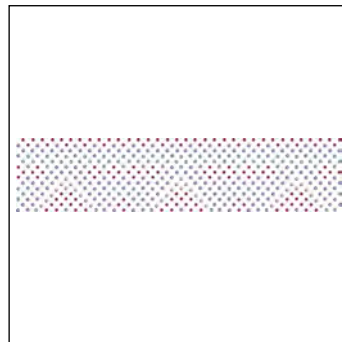

C 501/539/001SCGR/001SSHA
 E S8/S10/S10/S10
 S ~253x57
 M 9 PCS 17%

13 262 09

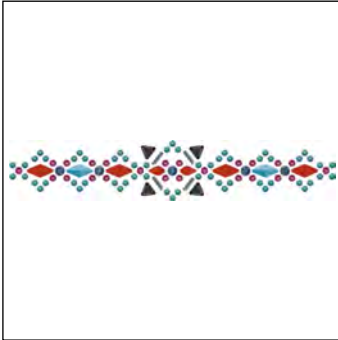

C 086266/092/R5003/R4007-001SCGR/280HEM/227/502
 E FFB16/M7x3/M12x6/M12x6-P3/CS7x6/2205MM7,5/S12
 S ~144x27
 M 30 PCS 30%

13 263 05

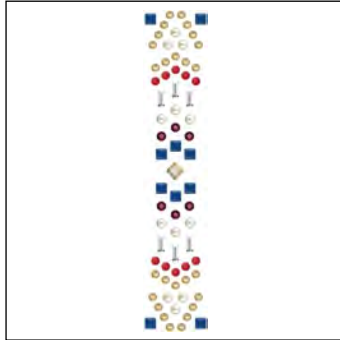

C R5021/R5009-001291/001/001GSHA/246/001L109S
 E M2,5/M3x3-P3/CS5x2/CS4x4/S8/S10
 S ~18x92
 M 72 PCS 46%

13 264 05

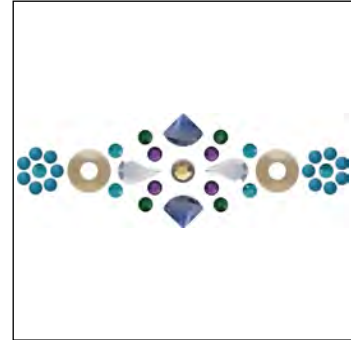

C 001GSHA GM/R5009/R1019-001/001BLSH/263/204/001L109S
 E FFB16/M2,5/M8-CS8x5/2714MM60/S10/S10/S10
 S ~61x21
 M 90 PCS 72%

13 265 05

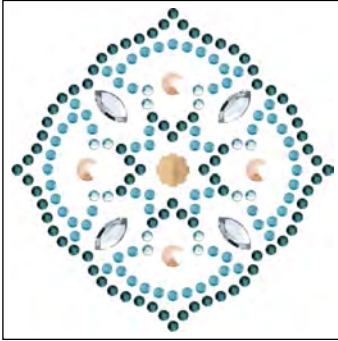

C R5021-001GSHA/001/229SAT/202/001GSHA
 E M2-P4/CS8x4/S6/S6/2612MM6
 S ~57x57
 M 51 PCS 74%

13 266 05

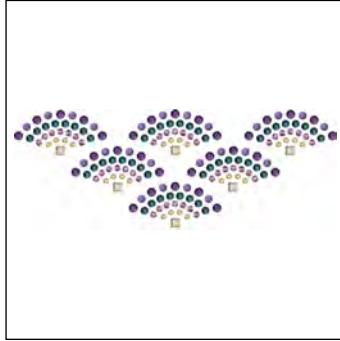

C R4005-001GSHA/246/001ANTP/229SAT/204
 E M2,5-CS3x3/S5/S6/S8/S10
 S ~99x36
 M 40 PCS 43%

13 267 05



C 266 GR/094/R4005-001/229SAT/001LUSH/001
 E FFB34/M2/M3-S3/S6/S8/2304MM10x2,8
 S ~42x92
 M 20 PCS 46%

13 269 06

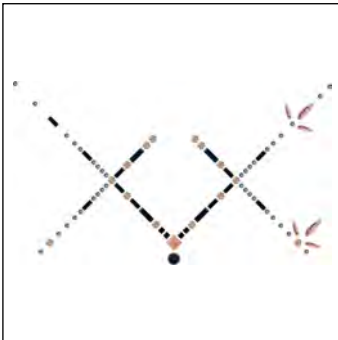

C 280 GM/R4007/R9005/R9005/R9005-257/257/001RABDK/001ROSPA
 E FFB34/M7x7/M3x3/M10x3/M7x3-2304MM10x2,8/2304MM14x3,9/S10/2034SS20
 S ~191x110
 M 8 PCS 22%

13 270 06



C 288/288/001AB/001SINI
 E S6/S10/2205MM7,5/2205MM10
 S ~33x38
 M 45 PCS 100%

13 272 05



C 266 GR/001GSHA GR/R5009/094-001291/001GSHA/246/001/001GSHA
 E FFB16/FFB20/M2/M3x3-P3/CS8x5/S6/2753MM10/S8
 S ~83x80
 M 20 PCS 54%

13 274

06

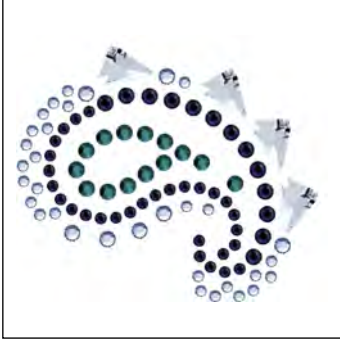

C	288/211/229SAT/288/211/000
E	S6/S6/S10/S10/S10/2739MM7x6,5
S	~49x42
M	68 PCS
	81%

TRANSFERS

A special motif is any individual design created by the customer that differs to the Transfers Standard, Crystal Inspiration, or Special Collections. This service opens up an abundance of customization possibilities. You also no longer need to set your motif by hand. You can rely on Swarovski's longstanding experience and design expertise and can order a convenient, ready-to-apply design. A range of customization options for existing motifs is available (see "Customization Possibilities" below). You can also submit design sketches that meet your special requirements – such as a brand image or an image for a particular sales campaign or garment. This will then be made up according to your specifications using Computer Aided Design, which means that adjustments can be made easily according to your needs.

CUSTOMIZATION POSSIBILITIES

- Change of elements in an existing motif
- Change of size of an existing motif
- Logos or brand names
- Creation of pieces or rows
- Up to nine colors possible per Transfer motif

For Transfers Unlimited

- Up to 18 elements possible per transfer motif
- max. motif size: 470x205 mm

ORDERING PROCESS

Send your request with the drawing you wish to order to your nearest Swarovski sales office. Make sure you include all measurements for the desired motif. Please also indicate which product group your special motif applies to (Transfers, Crystal-it, Crystal Mesh etc.). You will then receive a quotation including your article number, minimum order quantity, price, and the line drawing of your special motif in PDF format. Please contact your Swarovski sales office again if any changes are required. Your special motif will be produced and delivered following your confirmation.

SPECIAL MOTIF SERVICE

PLEASE NOTE

Please always submit the drawing of your desired motif to represent it in the actual size you require. A small sketch, when enlarged to the desired size, will have blurred lines that will make it difficult to correctly reproduce. Pictures or drawings representing 100% size of the design or very good quality scans in JPG, BMP, or DXF format will ensure that we have clear data to work with. These can also be sent via email or on CD-ROM. When the sketch is submitted as a hard copy by fax or e-mail, please include a scale legend (e.g. copy/scan with ruler next to the drawing). This will ensure that the desired size of the motif can be identified.

Special productions are generally offered to all our customers if these are deemed to be feasible and comply with our General Terms and Conditions. Please note that ordering a design does not grant exclusive production of this design to the customer.

TRANSFERS

SWAROVSKI

CERTIFICATE

meets the high standards set by Swarovski® and has therefore been certified as a

SWAROVSKI

AUTHORIZED WHOLESALER

This Authorized Wholesaler offers you:

- An extensive selection of high quality Swarovski crystals
- Good product knowledge on the brand Swarovski
- Flexibility and professionalism in customer service

The staff of this Authorized Wholesaler will be happy to inform you about Swarovski and the latest brand and presentation materials.

The certification is based on a sustainable business relationship with Swarovski and on the agreement of defined standards.



DATE AND PLACE OF ISSUE

EXPIRY DATE

SWAROVSKI

Swarovski's suggestions for Authorized Wholesalers are recommendations based on Swarovski's actual experience, current knowledge, and the information provided by the Authorized Wholesaler. Such advice does not prevent you from carrying out your own audits, examination, and selection. The selection of an Authorized Wholesaler is solely the customer's responsibility.